

						1	DISPLAYS	005
						2	BLACKBOARDS & SHOWCASES	079
						3	EVENTS	105
						4	STANCHIONS	185
						5	TENTS & INFLATABLES	199
						6	INFO HOLDERS & FRAMES	211
						7	TEXTIL	293
						8	SIGNAGE	353
						9	CABLE KIT	411
						10	PRODUCT EXHIBITION	425
						11	CARDBOARD	457
						12	P.O.S. SOLUTIONS	485
						13	COATING	565
						14	SHOPFITTING	583

Displays

01

A complete range of portable displays which provide an integral solution for the exhibition at promotional events, stores or business presentations.

- 06 X-BANNER
- 10 L-BANNER
- 12 ROLL UP | ECONOMIC
- 17 ROLL UP | STANDARD
- 21 ROLL UP | STYLISH
- 26 ROLL UP | DELUXE
- 31 ROLL UP | LARGE
- 34 ROLL UP ACCESSORIES
- 37 DESKTOP DISPLAYS
- 39 STAND DISPLAYS
- 47 REFILLABLE BASES
- 50 DISPLAY BASES
- 56 SIDEWALK BOARDS





X-BANNER Display

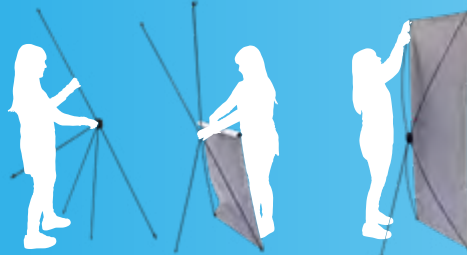

DISPLAY DETAILS

GRAPHIC BY EYELETS

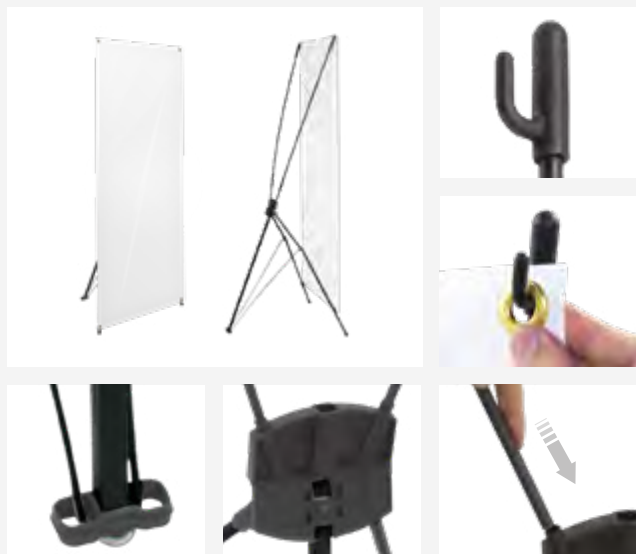

DIMENSIONS

*mm

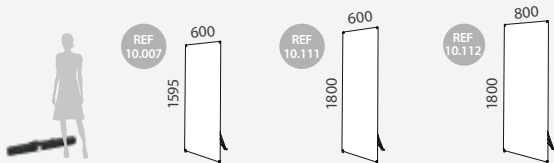

INFORMATION

UTILITIES

Tudela is a portable, detachable and lightweight display for interchanging graphics. Its X-shaped structure is made of fiberglass and plastic. The exhibitors can assemble it in a few seconds (no tools required). Tudela features 3 sizes available and it includes a carry bag.

TUDELA



	QTY	N.W	G.W	C.B.M	SIZE
Packing	10	9kg	10kg	0.0525	1010x200x260mm
Uni.	1	0.90kg	1kg	0.005	160x30x1080mm
10.007	Graphic Size: 600x1995mm				

	QTY	N.W	G.W	C.B.M	SIZE
Packing	10	9.5kg	10.5kg	0.0629	1210x200x260mm
Uni.	1	0.95kg	1.05kg	0.007	160x40x1210mm
10.111	Graphic Size: 600x1800mm				

	QTY	N.W	G.W	C.B.M	SIZE
Packing	10	10kg	11kg	0.0629	1210x200x260mm
Uni.	1	1kg	1.1kg	0.008	170x40x1210mm
10.112	Graphic Size: 800x1800mm				

DISPLAY DETAILS

GRAPHIC BY EYELETS

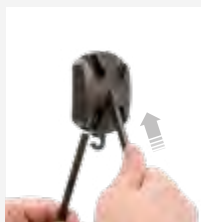

DIMENSIONS

*mm

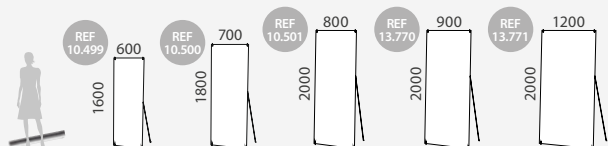

INFORMATION

UTILITIES

The Lyon X-Banner is a portable, detachable and very lightweight display for interchangeable graphics. Its X-shaped structure is made of fiberglass and plastic. Quickly assembly in seconds (no tools required). It includes a nylon carry bag. Lyon features 5 sizes available.

	QTY	N.W	G.W	C.B.M	SIZE
Packing	50	16.5kg	17.5kg	0.1298	350x350x1060mm
Uni.	1	0.30kg	0.35kg	0.009	140x60x1060mm
10.499	Graphic Size: 600x1600mm				

	QTY	N.W	G.W	C.B.M	SIZE
Packing	50	20kg	22kg	0.1484	400x350x1060mm
Uni.	1	0.35kg	0.40kg	0.009	140x60x1060mm
10.500	Graphic Size: 700x1800mm				

	QTY	N.W	G.W	C.B.M	SIZE
Packing	50	22.5kg	23.5kg	0.192	400x400x1200mm
Uni.	1	0.40kg	0.45kg	0.01	140x60x1200mm
10.501	Graphic Size: 800x2000mm				

	QTY	N.W	G.W	C.B.M	SIZE
Packing	20	14.6kg	15.7kg	0.178	1210x410x360mm
Uni.	1	0.73kg	1kg	0.01	140x60x1200mm
13.770	Graphic Size: 900x2000mm				

	QTY	N.W	G.W	C.B.M	SIZE
Packing	20	22kg	23.2kg	0.193	1260x510x300mm
Uni.	1	1.1kg	1.3kg	0.01	140x60x1200mm
13.771	Graphic Size: 1200x2000mm				

LYON

“ get extra tension using the hook with a counterweight ”



DISPLAY DETAILS



DISPLAY DETAILS

GRAPHIC ATTACHMENT BY EYELETS



DIMENSIONS *mm

UTILITIES

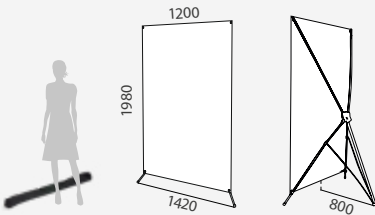

INFORMATION

Valoria X-Banner is a portable, detachable and lightweight display for interchangeable graphics. Its X-shaped structure is made of fiberglass and plastic parts. Exhibitors can quickly assemble it in a few seconds (no tools required). It includes a nylon carry bag. Because of its 1200mm width they are suitable for joining multiple units as a photocall or a promotional wall.

	QTY	N.W	G.W	C.B.M	SIZE
Packing	10	16kg	17kg	0.1170	1400x380x220mm
Uni.	1	1.60kg	1.70kg	0.008	200x30x1360mm
10.006	Graphic Size: 1200x1980mm				

VALORIA

1.2m
Width

COFFEE

77



DISPLAY DETAILS



DISPLAY DETAILS

GRAPHIC ATTACHMENT BY EYELETS

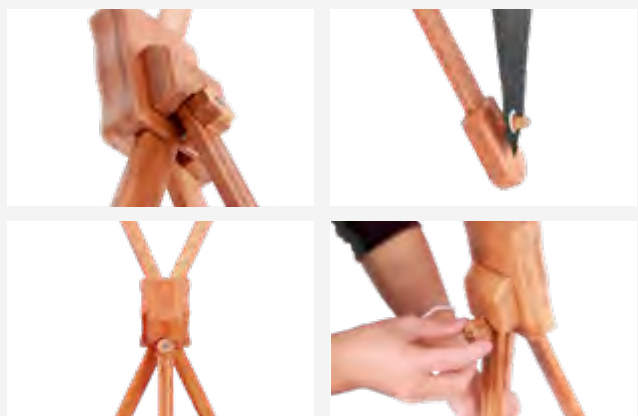

DIMENSIONS *mm

UTILITIES

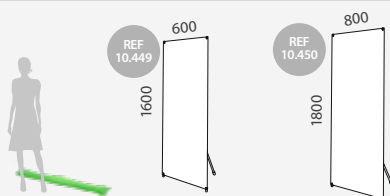

INFORMATION

The Bamboo X-Banner is a portable, detachable and lightweight display for interchangeable graphics. It is made of Bamboo Wood. Exhibitors can quickly assemble it in a few seconds (no tools required). A green nylon carry bag is included. Ideal for getting a touch of stylish and functional design.

	QTY	N.W	G.W	C.B.M	SIZE
Packing	40	20kg	22.50kg	0.13	450x270x130mm
Uni.	1	0.50kg	0.55kg	0.004	105x40x980mm
10.449	Graphic Size: 600x1600mm				

	QTY	N.W	G.W	C.B.M	SIZE
Packing	40	34kg	36kg	0.15	280x450x180mm
Uni.	1	0.85kg	0.90kg	0.005	105x40x1100mm
10.450	Graphic Size: 800x1800mm				

BAMBOO





L-BANNER Display



DISPLAY DETAILS



INFORMATION *mm

UTILITIES

Mestanza L-Banner is a detachable and lightweight display. Ideal for interchanging graphics. Its stable "L" shaped structure is easy to set-up with 3 simple steps. A nylon carry bag is included.

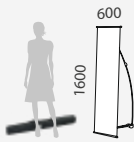

	QTY	N.W	G.W	C.B.M	SIZE
Packing	25	10kg	11.25kg	0.073	300x230x1060mm
Uni.	1	0.40kg	0.45kg	0.004	140x30x1060mm
10.774	Graphic Size: 600x1600mm				

MESTANZA

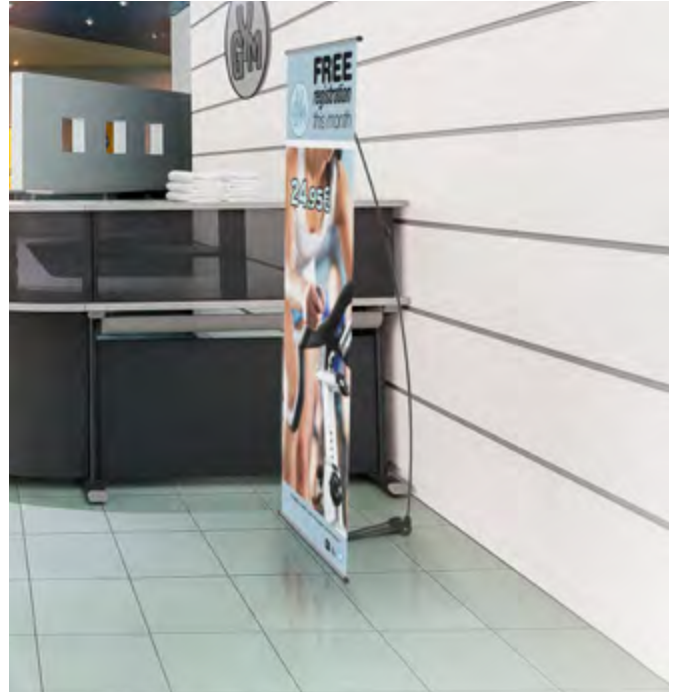

DISPLAY DETAILS

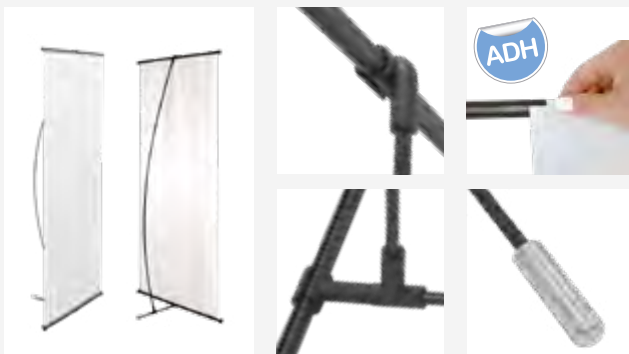

INFORMATION *mm

UTILITIES

Navas is a portable, detachable and lightweight display. Ideal for interchanging graphics. Its stable "L" shape can quickly assemble in seconds (graphic is attached by adhesive). A carry bag is included.

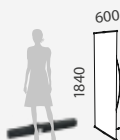

	QTY	N.W	G.W	C.B.M	SIZE
Packing	20	14kg	20kg	0.081	340x240x1000mm
Uni.	1	0.70kg	1kg	0.012	110x110x930mm
10.001	Graphic Size: 600x1840mm				

NAVAS



DISPLAY DETAILS



DIMENSIONS *mm

UTILITIES

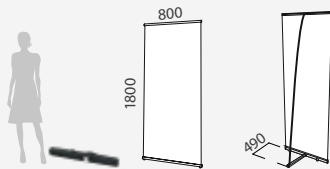

INFORMATION

Bonne L-Banner is a detachable and lightweight display for interchangeable graphics. It is made of aluminium and plastic. Its stable L-shaped structure (with 490mm depth) is very easy to set-up, so exhibitors can quickly assemble in only a few seconds (the graphic is attached by upper snap rail). Also, Bonn L-Banner includes a black nylon carry bag for a better transportation.

	QTY	N.W	G.W	C.B.M	SIZE
Packing	10	11kg	12kg	0.0498	830x200x300mm
Uni.	1	1.10kg	1.20kg	0.023	200x125x950mm
10.575	Graphic Size: 800x1800mm				

BONN





ROLL-UP Display



DISPLAY DETAILS



DIMENSIONS *mm

UTILITIES

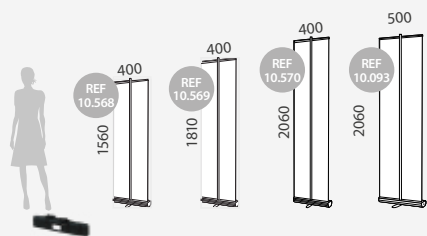

INFORMATION

Abadia Roll Up is a portable and lightweight display for interchangeable and retractable graphics. It is made of aluminium and plastic parts. Banner rolls up and down in seconds making setting up presentation quick and easy. It includes a carry bag for effortless transport. Abadia is ideal to display in front of columns.

	QTY	N.W	G.W	C.B.M	SIZE
Packing	10	7.5kg	8kg	0.04	450x210x470mm
Uni.	1	0.75kg	0.80kg	0.003	95x95x430mm
10.568	Graphic Size: 400x1560mm				

	QTY	N.W	G.W	C.B.M	SIZE
Packing	10	13kg	14kg	0.044	470x210x450mm
Uni.	1	1.3kg	1.4kg	0.003	95x95x430mm
10.569	Graphic Size: 400x1810mm				

	QTY	N.W	G.W	C.B.M	SIZE
Packing	10	14kg	15kg	0.044	470x210x450mm
Uni.	1	1.4kg	1.5kg	0.003	95x95x430mm
10.570	Graphic Size: 400x2060mm				

	QTY	N.W	G.W	C.B.M	SIZE
Packing	10	15kg	17kg	0.06	485x230x600mm
Uni.	1	1.5kg	1.7kg	0.004	95x95x550mm
10.093	Graphic Size: 500x2060mm				

ABADIA



“
Ideal for being used in front of columns
”

DISPLAY DETAILS



DIMENSIONS *mm

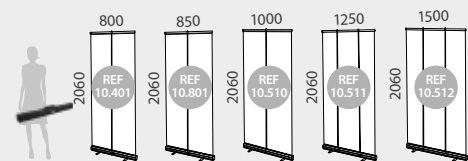

UTILITIES

INFORMATION

Alcala Roll Ups features 5 widths available. It is made of aluminium and plastic parts. Banner rolls up and down in seconds making setting up presentation quick and easy. Also it includes a single oxford carry bag.

	QTY	N.W	G.W	C.B.M	SIZE
Packing	6	11.5kg	12kg	0.05	300x210x850mm
Uni.	1	1.91kg	2kg	0.006	90x90x840mm

10.401 Graphic Size: 800x2060mm

	QTY	N.W	G.W	C.B.M	SIZE
Packing	6	12.5kg	13kg	0.06	300x210x900mm
Uni.	1	2.08kg	2.16kg	0.007	90x90x875mm

10.801 Graphic Size: 850x2060mm

	QTY	N.W	G.W	C.B.M	SIZE
Packing	6	14.5kg	15kg	0.07	300x210x1050mm
Uni.	1	2.41kg	2.5kg	0.008	90x90x1040mm

10.510 Graphic Size: 1000x2060mm

	QTY	N.W	G.W	C.B.M	SIZE
Packing	6	18.5kg	19kg	0.08	300x210x1300mm
Uni.	1	3.03kg	3.16kg	0.012	95x95x1270mm

10.511 Graphic Size: 1250x2060mm

	QTY	N.W	G.W	C.B.M	SIZE
Packing	6	20.5kg	21kg	0.10	300x210x1550mm
Uni.	1	3.41kg	3.50kg	0.013	100x95x1520mm

10.512 Graphic Size: 1500x2060mm

ALCALA

“ Use optional spotlight for highlight your exhibitions (sold separately) ”



ROLL UP BANNER Economic Roll Up

DISPLAY DETAILS



DIMENSIONS *mm



UTILITIES

INFORMATION

The Torino Roll Up features an unique and stable design with only one base foot. The banner rolls up and down in seconds. A nylon carry bag is included.

	QTY	N.W	G.W	C.B.M	SIZE
Packing	10	12.7kg	13.5kg	0.04	430x170x650mm
Uni.	1	1.27kg	1.35kg	0.005	90x90x625mm

13.827-600 Graphic Size: 600x2060mm

	QTY	N.W	G.W	C.B.M	SIZE
Packing	10	17kg	18kg	0.06	430x170x850mm
Uni.	1	1.7kg	1.8kg	0.006	90x90x825mm

13.827-800 Graphic Size: 800x2060mm

	QTY	N.W	G.W	C.B.M	SIZE
Packing	10	19kg	20kg	0.06	430x170x900mm
Uni.	1	1.9kg	2kg	0.007	90x90x875mm

13.827-850 Graphic Size: 850x2060mm

	QTY	N.W	G.W	C.B.M	SIZE
Packing	10	21kg	22kg	0.07	430x170x1050mm
Uni.	1	2.1kg	2.2kg	0.008	90x90x1025mm

13.827-1000 Graphic Size: 1000x2060mm

	QTY	N.W	G.W	C.B.M	SIZE
Packing	10	25kg	26kg	0.09	430x170x1250mm
Uni.	1	2.5kg	2.6kg	0.009	90x90x1225mm

13.827-1200 Graphic Size: 1200x2060mm

TORINO



ROLL UP BANNER Economic Roll Up

ACCESORY DETAILS



INFORMATION

Torino features a kit of accessories (sold separately) which allow you to join together with another Torino and get a 2-sided view. Set up is easy, just line up the 2 Units, connect the bases, raise the banners and connect them at top.

ASSEMBLY INSTRUCTIONS



2-SIDED KIT ACCESORY FOR TORINO



	QTY	N.W	G.W	C.B.M	SIZE
Packing	10	4.5kg	5kg	0.017	430x220x180mm
Uni.	1	0.45kg	0.47kg	0.0057	250x150x150mm
13.828	Double Side Accessories Kit				

DISPLAY DETAILS

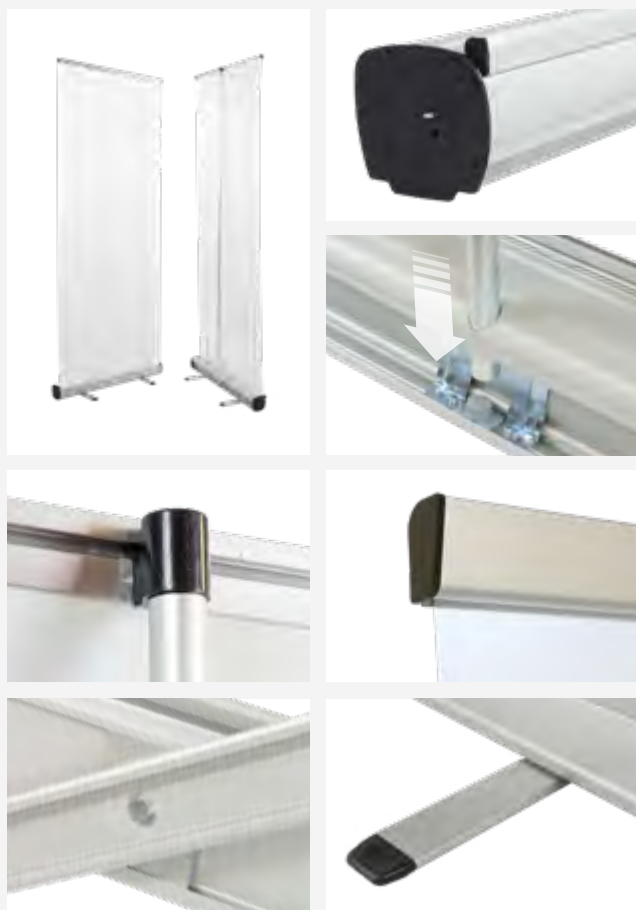

DIMENSIONS *mm

UTILITIES

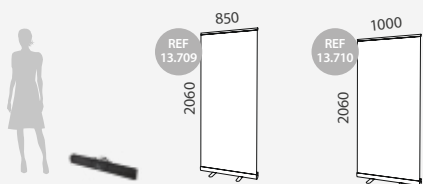

INFORMATION

The Sidney Roll Up is a quick yet economical solution for your business presentation needs. It features metal connections at base feet and also, an improved stability thanks its special joining pole piece. It is made of anodized aluminium and plastic parts. Also it includes a hand strap carry bag.

	QTY	N.W	G.W	C.B.M	SIZE
Packing	6	10.8kg	12kg	0.051	300x200x850mm
Uni.	1	1.8kg	2kg	0.007	90x90x875mm
13.709	Graphic Size: 850x2060mm				

	QTY	N.W	G.W	C.B.M	SIZE
Packing	6	13.8kg	15kg	0.063	300x200x1050mm
Uni.	1	2.3kg	2.5kg	0.008	90x90x1040mm
13.710	Graphic Size: 1000x2060mm				

SIDNEY



DISPLAY DETAILS



DIMENSIONS *mm

UTILITIES

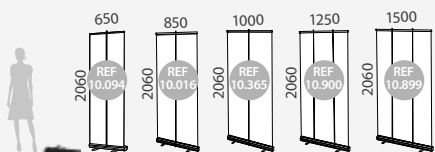

INFORMATION

The Alberca Roll Up features an extra weight aluminium structure with 5 widths available. Banner rolls up and down in seconds making setting up presentation quick and easy. Also it includes a double padded carry bag.

	QTY	N.W	G.W	C.B.M	SIZE
Packing	6	15kg	16kg	0.051	320x230x700mm
Uni.	1	2.5kg	2.66kg	0.005	95x95x650mm
10.094	Graphic Size: 650x2060mm				
	QTY	N.W	G.W	C.B.M	SIZE
Packing	6	17.5kg	18kg	0.07	320x230x900mm
Uni.	1	2.91kg	3kg	0.009	100x100x890mm
10.016	Graphic Size: 850x2060mm				
	QTY	N.W	G.W	C.B.M	SIZE
Packing	6	19.5kg	20kg	0.08	320x230x1050mm
Uni.	1	3.5kg	3.33kg	0.011	100x100x1040mm
10.365	Graphic Size: 1000x2060mm				
	QTY	N.W	G.W	C.B.M	SIZE
Packing	6	21.5kg	22kg	0.10	320x230x1300mm
Uni.	1	3.58kg	3.66kg	0.012	100x100x1300mm
10.900	Graphic Size: 1250x2060mm				
	QTY	N.W	G.W	C.B.M	SIZE
Packing	6	23kg	24kg	0.11	320x230x1550mm
Uni.	1	3.83kg	4kg	0.015	100x100x1540mm
10.899	Graphic Size: 1500x2060mm				

ALBERCA

“Get stability and extra weight thanks its higher aluminium thickness”

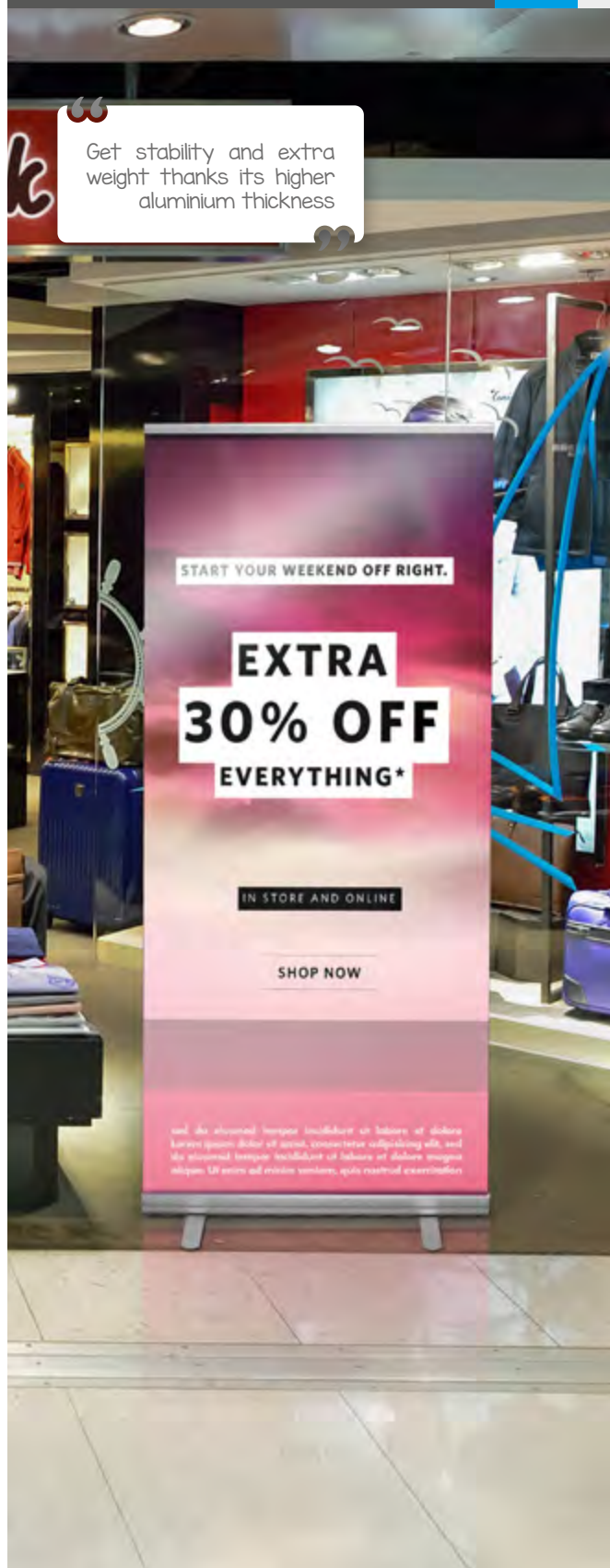

DISPLAY DETAILS



DIMENSIONS *mm

UTILITIES

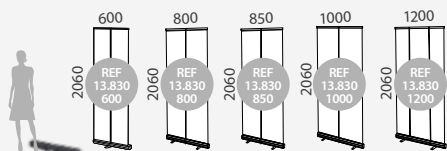

	QTY	N.W	G.W	C.B.M	SIZE
Packing	6	16.2kg	16.65kg	0.05	350x240x670mm
Uni.	1	2.70kg	2.77kg	0.009	110x110x650mm

13.830-600 Graphic Size: 600x2060mm

	QTY	N.W	G.W	C.B.M	SIZE
Packing	6	19.9kg	20kg	0.07	350x240x670mm
Uni.	1	3.2kg	3.33kg	0.012	110x110x850mm

13.830-800 Graphic Size: 800x2060mm

	QTY	N.W	G.W	C.B.M	SIZE
Packing	6	20.4kg	21kg	0.07	350x240x920mm
Uni.	1	3.4kg	3.5kg	0.012	110x110x900mm

13.830-850 Graphic Size: 850x2060mm

	QTY	N.W	G.W	C.B.M	SIZE
Packing	6	21.3kg	22.2kg	0.08	350x240x1070mm
Uni.	1	3.55kg	3.7kg	0.014	110x110x1050mm

13.830-1000 Graphic Size: 1000x2060mm

	QTY	N.W	G.W	C.B.M	SIZE
Packing	6	27.6kg	29.45kg	0.10	350x240x1270mm
Uni.	1	4.6kg	4.9kg	0.017	110x110x1250mm

13.830-1200 Graphic Size: 1200x2060mm

ORLEANS



DISPLAY DETAILS



INFORMATION

Orleans is one of the best-selling Roll-Ups in the world. Featuring an extra weight aluminium structure with 10 sizes available. Banner rolls up and down in seconds making setting up presentation quick and easy. Includes a double padding carry bag with all crossed zip and hand strap for an easy transportation.

DIMENSIONS *mm

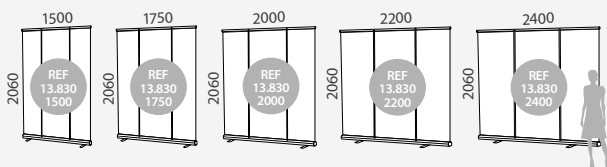

	QTY	N.W	G.W	C.B.M	SIZE
Packing	4	22kg	23.4kg	0.09	250x250x1580mm
Uni.	1	5.5kg	5.85kg	0.024	120x120x1560mm

13.830-1500 Graphic Size: 1500x2060mm

	QTY	N.W	G.W	C.B.M	SIZE
Packing	2	11.8kg	12.3kg	0.05	130x250x1830mm
Uni.	1	5.9kg	6.15kg	0.029	120x120x1810mm

13.830-1750 Graphic Size: 1750x2060mm

	QTY	N.W	G.W	C.B.M	SIZE
Packing	2	13kg	14kg	0.06	130x250x2070mm
Uni.	1	6.5kg	7kg	0.033	120x120x2050mm

13.830-2000 Graphic Size: 2000x2060mm

	QTY	N.W	G.W	C.B.M	SIZE
Packing	2	14.6kg	15.4kg	0.07	130x250x2270mm
Uni.	1	7.3kg	7.7kg	0.036	120x120x2250mm

13.830-2200 Graphic Size: 2200x2060mm

	QTY	N.W	G.W	C.B.M	SIZE
Uni.	1	8.2kg	8.5kg	0.08	130x130x2470mm

13.830-2400 Graphic Size: 2400x2060mm

ORLEANS

“ Use promotional counters for completing your exhibitions (sold separately) ”



DISPLAY DETAILS

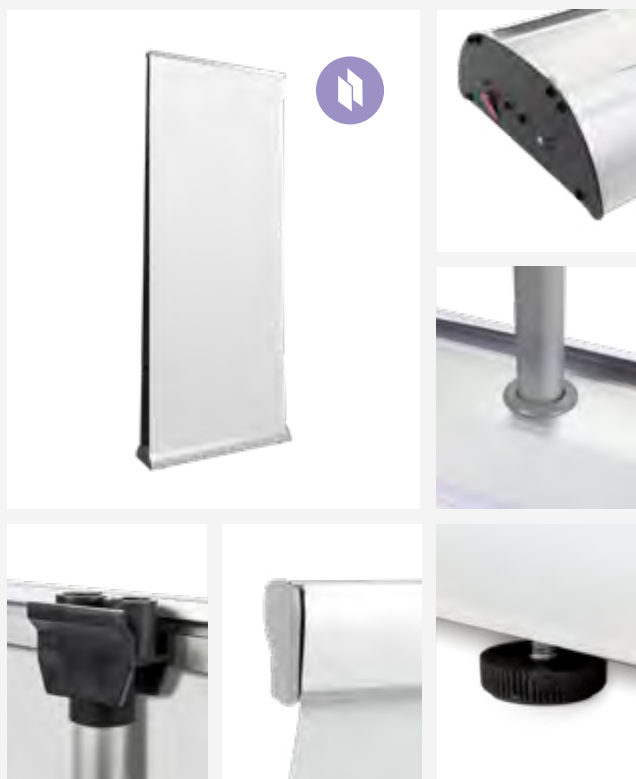

DIMENSIONS *mm

UTILITIES

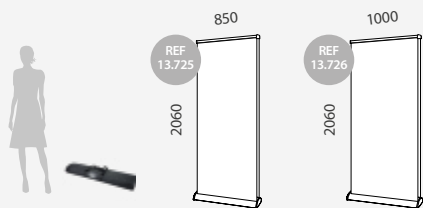

INFORMATION

Mora is a Double Sided Roll Up wich features 2 widths available (850mm or 1000mm). It is made of aluminium and plastic parts. Banner rolls up and down in seconds making setting up presentation quick and easy. Mora features a stable base with no-feet design with leveling feet. Also it includes a carry bag. Ideal for trade shows, expositions, retail stores or any media event.

	QTY	N.W	G.W	C.B.M	SIZE
Packing	4	15.6kg	18.8kg	0.02727	890x190x430mm
Uni.	1	3.90kg	4.70kg	0.021	900x130x180mm
13.725	Graphic Size: 850x2060mm				

	QTY	N.W	G.W	C.B.M	SIZE
Packing	4	17.6kg	21kg	0.0850	1040x190x430mm
Uni.	1	4.40kg	5.25kg	0.024	1040x130x180mm
13.726	Graphic Size: 1000x2060mm				

MORA



DISPLAY DETAILS



DIMENSIONS *mm

UTILITIES

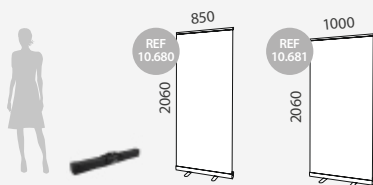

INFORMATION

This Roll Up features a full black finish and it is made of durably aluminum so it is incredibly lightweight and saves floor space. Easy change of graphic, set up is quick and easy, just connect the pole to the base, roll-up the graphic and hook it at the top of the pole. With canvas carry bag included. Ideal for trade shows, expositions, retail stores or any media event.

	QTY	N.W	G.W	C.B.M	SIZE
Packing	10	22kg	24kg	0.093	490x210x910mm
Uni.	1	2.20kg	2.40kg	0.007	90x90x875mm
10.680	Graphic Size: 850x2060mm				

	QTY	N.W	G.W	C.B.M	SIZE
Packing	10	25kg	26kg	0.109	490x210x1060mm
Uni.	1	2.50kg	2.60kg	0.011	105x105x1040mm
10.681	Graphic Size: 1000x2060mm				

ALTEA

Use optional spotlight for highlight your exhibitions (sold separately)



DISPLAY DETAILS



DIMENSIONS *mm

UTILITIES



INFORMATION

This Roll Up banner is made of durably aluminum with plastic parts so it is incredibly lightweight and slim-line design that makes it visually appealing and saves floor space. Easy change of graphic, set up is quick and easy, users can simply connect the pole to the base, roll-up the graphic and hook the banner at the top of the pole. Additionally, a canvas carry bag is included. Ideal for trade shows, expositions, retail stores or any media event.

	QTY	N.W	G.W	C.B.M	SIZE
Packing	6	14.4kg	14.8kg	0.0786	320x270x910mm
Uni.	1	2.4kg	2.8kg	0.01	110x105x890mm
13.578	Graphic Size: 850x2060mm				

	QTY	N.W	G.W	C.B.M	SIZE
Packing	6	16.8kg	17.4kg	0.0926	320x270x1060mm
Uni.	1	2.8kg	3.3kg	0.011	105x105x1040mm
13.579	Graphic Size: 1000x2060mm				

DUERO

offee Bear



DISPLAY DETAILS



DIMENSIONS *mm

UTILITIES

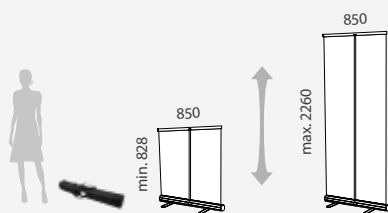

INFORMATION

This Roll Up banner is made of durably aluminum with plastic parts so it is incredibly lightweight and saves floor space. Featuring stylish open bases and adjustable height thanks to its telescopic pole. With an easy change of graphic, set up is quick and easy. Additionally, a canvas carry bag is included. Ideal for trade shows, expositions, retail stores or any media event.

	QTY	N.W	G.W	C.B.M	SIZE
Packing	6	17kg	18kg	0.072	320x250x900mm
Uni.	1	2.83kg	3kg	0.01	110x110x900mm
10.020	Graphic Size: 850x828-2260mm				

DEHESA



Get an extra height thanks its telescopic aluminium pole

DISPLAY DETAILS



DIMENSIONS *mm

UTILITIES

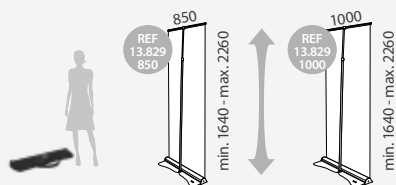

INFORMATION

Milano Roll Up is made of durably aluminum with plastic parts. It features an easy change of graphic thanks its unique design with a interchangeable cassette, graphic change is quick and easy, users can simply put the cassette into the base, roll-up the graphic and hook the banner at the top of the pole. Additionally, a canvas carry bag is included. Ideal for trade shows, expositions, retail stores or any media event.

	QTY	N.W	G.W	C.B.M	SIZE
Packing	4	16kg	17kg	0.07	300x260x920mm
Uni.	1	4kg	4.25kg	0.01	150x130x875mm
13.829-850	Graphic Size: 850x1640-2260mm				

MILANO 1000	QTY	N.W	G.W	C.B.M	SIZE
Packing	4	18kg	19kg	0.08	300x260x1000mm
Uni.	1	4.5kg	4.75kg	0.02	150x130x1025mm
13.829-1000	Graphic Size: 1000x1640-2260mm				

MILANO



“ With an comfortable and fast change of graphic thanks its interchangeable cassette. ”

DISPLAY DETAILS



DISPLAY DETAILS

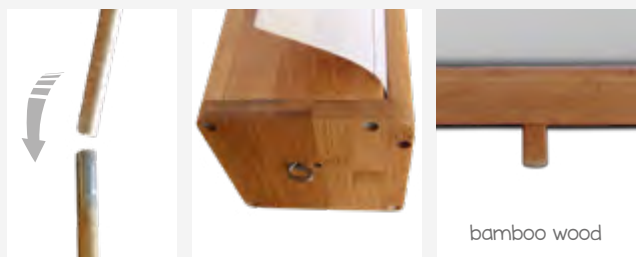

INFORMATION

DIMENSIONS *mm

UTILITIES

This Roll Up is made of bamboo wood. Featuring stylish natural design. With an easy change of graphic, set up is quick and easy. A nylon carry bag is included. Ideal for trade shows, expositions, retail stores or any event.

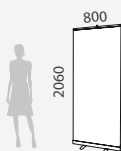

	QTY	N.W	G.W	C.B.M	SIZE
Packing	4	12.6kg	15.2kg	0.091	350x290x900mm
Uni.	1	3.15kg	3.80kg	0.02	170x140x870mm
10.444	Graphic Size: 800x2060mm				

BAMBOO





DISPLAY DETAILS



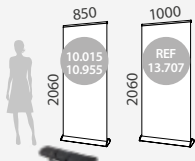

INFORMATION DIMENSIONS *mm UTILITIES

Cervera Roll Up features silver or black finish available. The aluminum design is durable, yet attractive and adds a stylish and luxurious touch. It has leveling feet and also, includes a double padded carry bag.



	QTY	N.W	G.W	C.B.M	SIZE	
Packing	4	17.4kg	20.6kg	0.083	890x190x430mm	
Uni.	1	4.35kg	5.15kg	0.018	150x135x920mm	
10.015	Graphic Size: 850x2060mm					

	QTY	N.W	G.W	C.B.M	SIZE	
Packing	4	21.6kg	23.2kg	0.097	450x200x1080mm	
Uni.	1	5.4kg	5.8kg	0.0216	150x135x1070mm	
13.707	Graphic Size: 1000x2060mm					

	QTY	N.W	G.W	C.B.M	SIZE	
Packing	4	17.6kg	21kg	0.083	890x190x430mm	
Uni.	1	4.4kg	5.25kg	0.018	150x135x920mm	
10.955	Graphic Size: 850x2060mm					

CERVERA

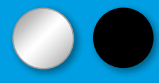

“ Ideal for providing a distinguishing and stylish touch. ”

DISPLAY DETAILS



INFORMATION

DIMENSIONS *mm

UTILITIES

Ribas luxury Roll Up features silver finish. Its unique design is durable, yet attractive. Its base has leveling feet. It is double-sided so it can be used as a sidewalk stand (ideal for areas with 2-ways traffic). Double padded carry bag.

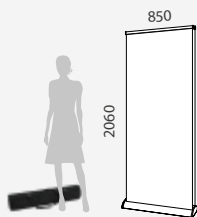

	QTY	N.W	G.W	C.B.M	SIZE
Packing	4	28kg	28.8kg	0.156	300x530x980mm
Uni.	1	7kg	7.2kg	0.03	250x135x920mm
10.013	Graphic Size: 850x2060mm				

RIBAS



DISPLAY DETAILS

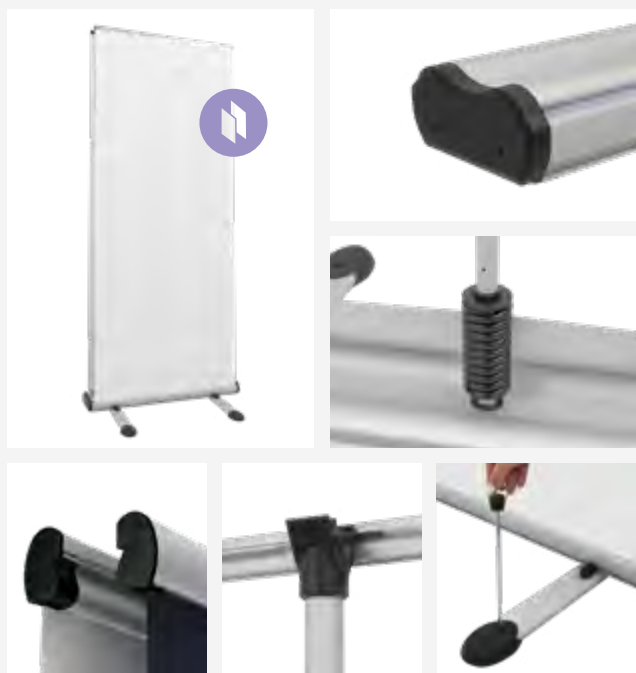

FLEX SYSTEM

*mm

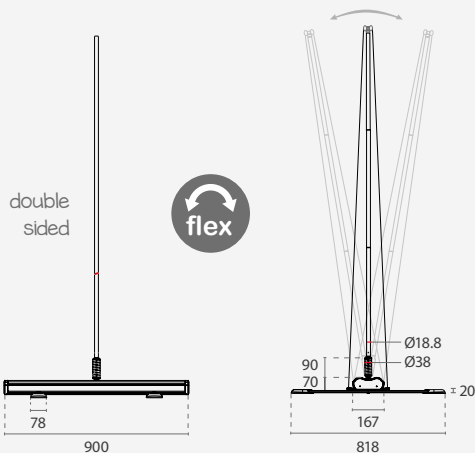

INFORMATION

DIMENSIONS *mm

UTILITIES

Ibiza RollUp features a silver aluminium finish and it is suitable for outdoor or indoor use. Its design features a flex system for resisting wind. Feet are holed for being used with 4 stakes (included). It is ideal for areas with 2-ways traffic. Double padded carry bag.

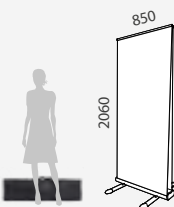

IBIZA



	QTY	N.W	G.W	C.B.M	SIZE
Packing	1	7.6kg	8.8kg	0.03	300x110x930mm
10.447	Graphic Size: 850x2060mm				

DISPLAY DETAILS

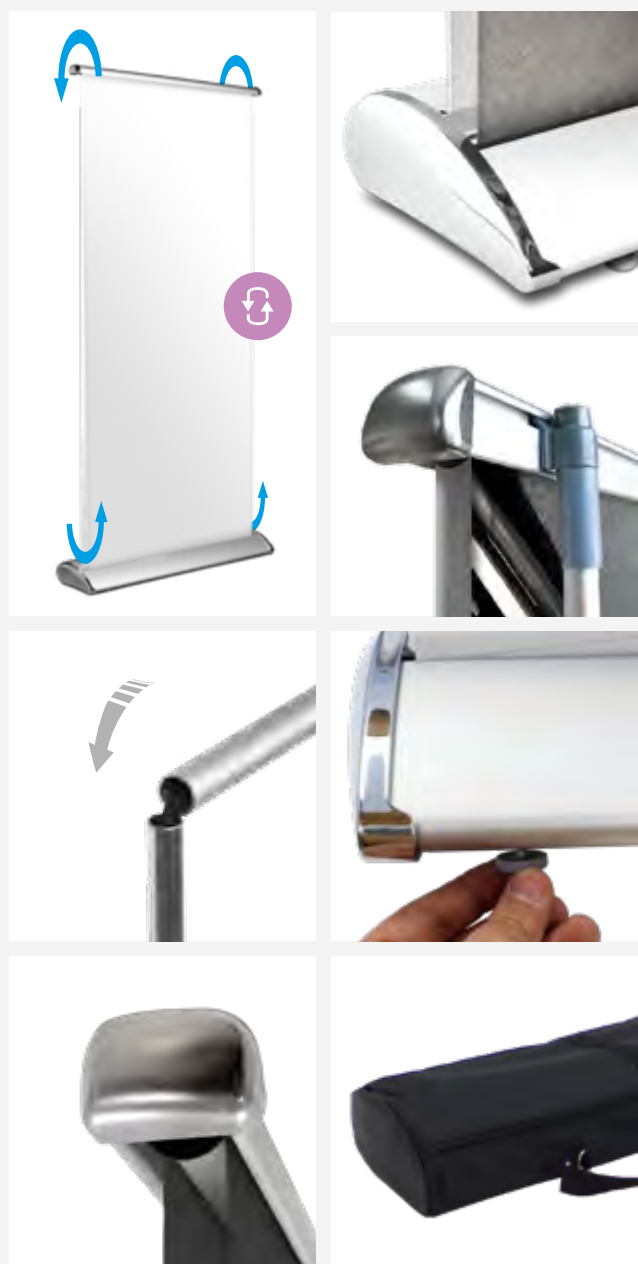

INFORMATION

DIMENSIONS *mm

UTILITIES

Pineda Roll Up features an electrical scrolling design which allows to display a large 4105mm and continuous graphic banner. Its base has leveling feet and it includes a double padded carry bag.

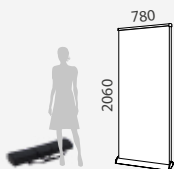

	QTY	N.W	G.W	C.B.M	SIZE
Packing	4	19.80kg	24.60kg	0.16	530x300x980mm
Uni.	1	4.95kg	6.15kg	0.034	280x130x925mm
10.022	Graphic: 780x4105mm		Visible: 780x2060mm		

PINEDA SCROLL



DISPLAY DETAILS

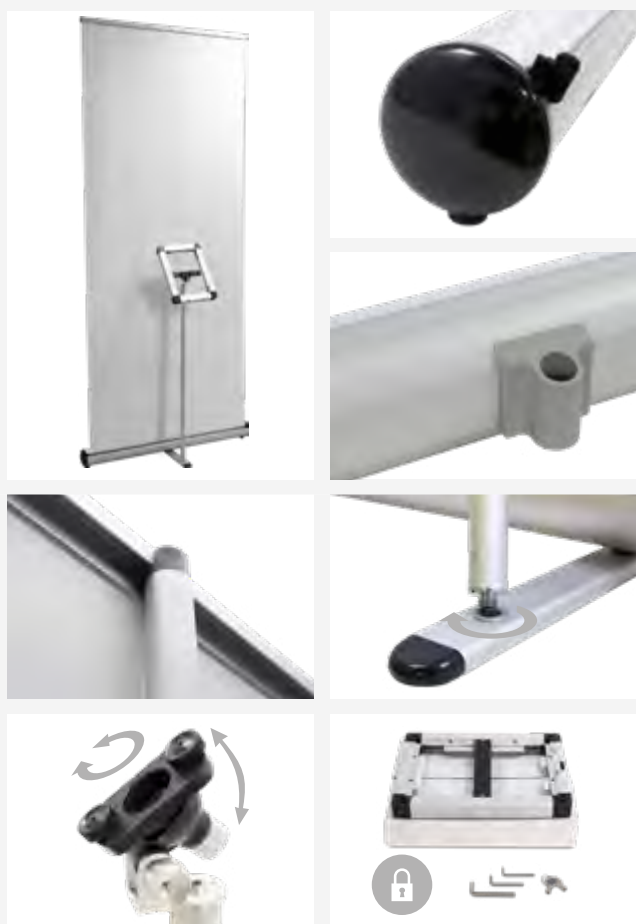

DIMENSIONS *mm

UTILITIES



INFORMATION

This Roll Up features a tablet holder (2 sizes available) whose frame allows a 360° rotation. Also, it has lock for safety use. It includes a double padded carry bag. Pineda Scroll Roll Up is ideal for conventions, tradeshows, expositions, media events or any business presentation.

	QTY	N.W	G.W	C.B.M	SIZE
Packing	1	0.75kg	0.90kg	0.003	260x47x310mm
		3.60kg	4.10kg	0.013	130x110x930mm
10.035	Roll Up Graphic Size: 850x2060mm Size for Tablets: ±185.8x241.3mm				

	QTY	N.W	G.W	C.B.M	SIZE
Packing	1	0.75kg	0.90kg	0.003	260x47x310mm
		3.60kg	4.10kg	0.013	130x110x930mm
10.053	Roll Up Graphic Size: 850x2060mm Size for Tablets: ±195.5x240mm				

TABLET HOLDER ROLL UP

“ See more Tablet Holders in InFo & Frames (Chapter 6) ”



* tablet is not included

DISPLAY DETAILS

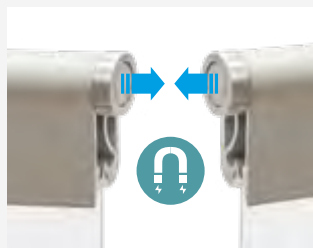

DIMENSIONS *mm

UTILITIES

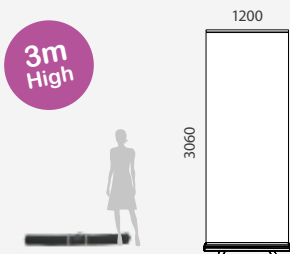

INFORMATION

The Everest Roll Up banner is made of durable aluminium with magnetic side connection parts, featuring 3m height. At the top of each banner stand, there are patented magnetic connectors that allow you to join together multiple units with a simple "click". Because of its size, it is a great alternative to pop up displays so it is ideal for trade show booths, press conferences, convention centers, malls, exhibitions, retail stores or any other media event.

	QTY	N.W	G.W	C.B.M	SIZE
Packing	6	40.2kg	45kg	0.15	420x290x1260mm
Uni.	1	6.50kg	7.30kg	0.018	120x120x1260mm
10.861	Graphic Size: 1200x3060mm				

EVEREST



Join it with other Everest Roll Up for creating a photocall



DISPLAY DETAILS



DIMENSIONS

*mm

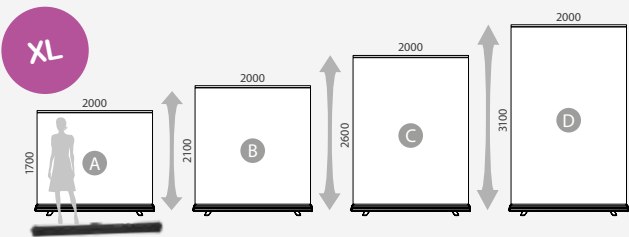

INFORMATION

UTILITIES

If you are looking for something bigger, the Mont Blanc Roll Up is 2000mm wide and features four adjustable heights: 1700, 2100, 2600 and 3100mm. It is the perfect alternate to a pop up display. Due to its large height, assembly is easiest when you set up along the floor and then stand the display up. Also thanks to its telescopic capacity, can be used in any other smaller places, with a minimum height of 1700mm. It comes with a carrying bag.

	QTY	N.W	G.W	C.B.M	SIZE
Packing	1	13kg	14.80kg	0.061	180x160x2120mm
10.441	Graphic Size: 2000x A B C D mm				

MONT BLANC



ROLL UP BANNER Large Roll Up

DISPLAY DETAILS



DIMENSIONS

UTILITIES *mm

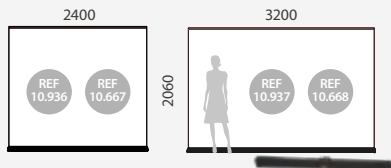

INFORMATION

Max Elda is the widest Roll Up, made of sturdy aluminium features 2 different widths, 2400 and 3200mm. Silver and black finish is available. Additionally, it includes a canvas carry nylon bag for easier transport.

	QTY	N.W	G.W	C.B.M	SIZE	
Packing	2	21.2kg	26.6kg	0.189	320x230x2580mm	
Uni.	1	10.6kg	13.3kg	0.071	320x90x2480mm	
10.936	Graphic Size: 2400x2060mm					
	QTY	N.W	G.W	C.B.M	SIZE	
Packing	2	22kg	30.1kg	0.253	320x230x440mm	
Uni.	1	11kg	15.05kg	0.096	320x90x3340mm	
10.937	Graphic Size: 3200-2060mm					
	QTY	N.W	G.W	C.B.M	SIZE	
Packing	2	21.2kg	26.6kg	0.189	320x230x2580mm	
Uni.	1	10.6kg	13.3kg	0.071	320x90x2480mm	
10.667	Graphic Size: 2400x2060mm					
	QTY	N.W	G.W	C.B.M	SIZE	
Packing	2	22kg	30.1kg	0.253	320x230x440mm	
Uni.	1	11kg	15.05kg	0.096	320x90x3340mm	
10.668	Graphic Size: 3200x2060mm					

MAX ELDA



* optional counter (sold apart, see later in Events chapter)

BAG DETAILS



INFORMATION

*mm

- One side zipped. With Id Pocket.
- Shoulder and hand strap.



850 | 1000 | 1250 | 1500

	QTY	N.W	G.W	C.B.M	SIZE
Packing	1	0.12kg	0.22kg	0.0035	120x30x980mm
13.461	For Roll Up 850mm				
	QTY	N.W	G.W	C.B.M	SIZE
Packing	1	0.15kg	0.25kg	0.0037	120x30x1030mm
13.462	For Roll Up 1000mm				
	QTY	N.W	G.W	C.B.M	SIZE
Packing	1	0.17kg	0.30kg	0.0046	120x30x1300mm
13.433	For Roll Up 1250mm				
	QTY	N.W	G.W	C.B.M	SIZE
Packing	1	0.50kg	0.70kg	0.0074	120x40x1550mm
13.778	For Roll Up 1500mm				

SINGLE OXFORD BAG



BAG DETAILS

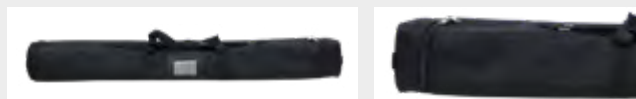

INFORMATION

*mm

- Zipper on one side. With ID Pocket.
- Shoulder and hand strap. Double padded



500 | 650 | 850 | 1000

	QTY	N.W	G.W	C.B.M	SIZE
Packing	1	0.20kg	0.40kg	0.00288	120x40x600mm
13.494	For Roll Up 500mm				
	QTY	N.W	G.W	C.B.M	SIZE
Packing	1	0.28kg	0.50kg	0.0036	120x40x750mm
13.495	For Roll Up 650mm				
	QTY	N.W	G.W	C.B.M	SIZE
Packing	1	0.40kg	0.60kg	0.0047	120x40x980mm
13.463	For Roll Up 850mm				
	QTY	N.W	G.W	C.B.M	SIZE
Packing	1	0.50kg	0.70kg	0.0049	120x40x1030mm
13.464	For Roll Up 1000mm				

DOUBLE PADDED BAG



BAG DETAILS



INFORMATION

*mm

- All crossed zipped.
- Shoulder and hand strap.
- With transparent pocket for ID Tag.

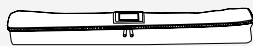

850 | 1000

	QTY	N.W	G.W	C.B.M	SIZE
Packing	1	0.40kg	0.60kg	0.004	120x40x980mm
13.459	For Roll Up 850mm				
	QTY	N.W	G.W	C.B.M	SIZE
Packing	1	0.50kg	0.70kg	0.004	120x40x1030mm
13.460	For Roll Up 1000mm				

DOUBLE PADDED ZIPPED BAG

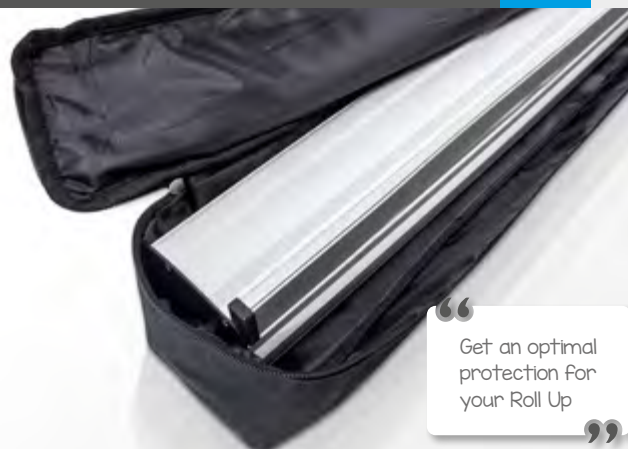

“ Get an optimal protection for your Roll Up ”

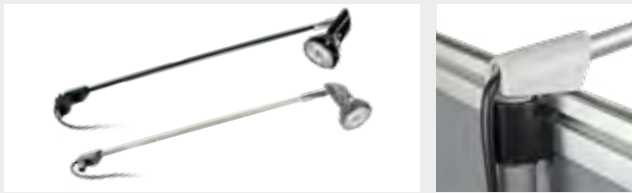

SPOTLIGHT DETAILS



INFORMATION *mm

Spotlights for Roll Up with Plug-in base at top the pole. Bulb type Halogen (included) and directional head, large luminous capacity. Spotlight works directly plugged in. Black or matt aluminium finish.



	QTY	N.W	G.W	C.B.M	SIZE
Uni.	1	0.32kg	0.40kg	0.002	80x70x460mm
10.055					50 w
10.056					

PLUG-IN SPOTLIGHT
FOR ROLL UP



SPOTLIGHT DETAILS



INFORMATION *mm

LED light spotlight with clamp adjustment for Roll Up. Works directly plugged in. Chrome finish and 12w LED light. With clamp for quick and easy use.

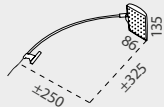

	QTY	N.W	G.W	C.B.M	SIZE
Packing	1	0.4kg	0.8kg	0.0038	150x50x510mm
10.687					12 w

LED CLAMP SPOTLIGHT
FOR ROLL UP



SPOTLIGHT DETAILS

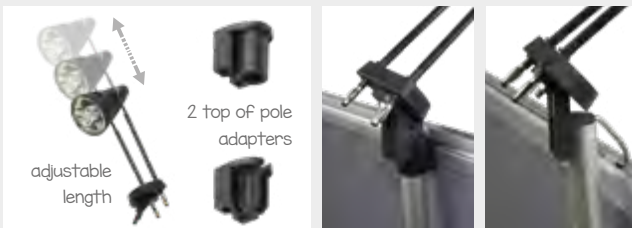

INFORMATION *mm

60w halogen bulb included. Telescopic (adjustable length). With 2 adapters for tops of the pole (plug-in and cap bases). Ideal to fit most Roll Ups on market. Large luminous capacity.

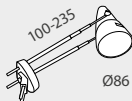

	QTY	N.W	G.W	C.B.M	SIZE
Packing	1	0.30kg	0.35kg	0.0016	125x65x200mm
10.525					60 w

TELESCOPIC SPOTLIGHT
FOR ROLL UP



* Roll Up not included.

HANGER DETAILS

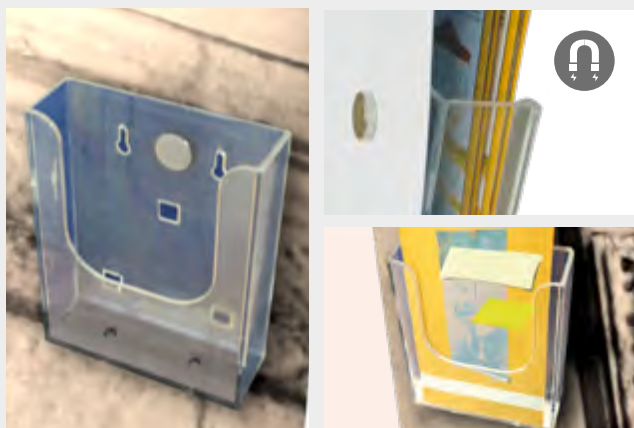

INFORMATION

*mm

Acrylic Brochure Holder for A6 leaflet size. Double magnet fixing system. No tools required. Ideal for any Roll Up.

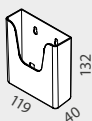

	QTY	N.W	G.W	C.B.M	SIZE
Packing	5	0.85kg	0.95kg	0.004	165x130x215mm

10.860 Graphic Size: A6 x5 

MAGNETIC BROCHURE HOLDER



BAG FOR SPOTLIGHT ROLL UP

BAG DETAILS



easy transport by handle



INFORMATION

*mm

The Oxford Bag is made of black nylon and all crossed zipped. It protects and extends the life of your Roll Up Spotlights. Easy transport by handle.

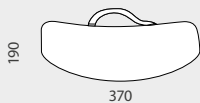

	QTY	N.W	G.W	C.B.M	SIZE
Packing	1	0.10kg	0.20kg	0.002	190x30x370mm

13.454

GRAPHIC CASE

CASE DETAILS



INFORMATION

Graphics case made of sturdy PVC. Features a shoulder strap for better carrying. Available in two colours (black and grey) and three different sizes.

	QTY	N.W	G.W	C.B.M	SIZE
Uni.	1	0.4kg	0.42kg	0.006	100x100x640mm
10.074		Ø107mm 640-1070mm			
10.075					

	QTY	N.W	G.W	C.B.M	SIZE
Uni.	1	0.5kg	0.52kg	0.008	100x100x780mm
10.076		Ø107mm 779-1280mm			
10.077					

	QTY	N.W	G.W	C.B.M	SIZE
Uni.	1	0.3kg	0.32kg	0.004	80x60x630mm
10.078		Ø85mm 630-1070mm			
10.079					

* Roll Up not included / Roll Up non inclus / Roll Up não inclusos / Roll Up no inclusos.

DISPLAY DETAILS



INFORMATION

Re-writable and erasable Led Board, Daganzo is available in A4 and A5 format. Featuring 12 modes of bright Neon Effects. It includes rechargeable battery, marker and screen eraser. Daganzo is ideal for promoting upcoming shows, special offers, dinners, special drinks at your bar or restaurant, or at party drawing as notice board and more.

REF 10.308

REF 10.307



	QTY	N.W	G.W	C.B.M	SIZE
Packing	40	7.6kg	15.6kg	0.1	440x420x530mm
Uni.	1	0.19kg	0.39kg	0.003	170x100x220mm
10.308	Graphic Size: A5				
	QTY	N.W	G.W	C.B.M	SIZE
Packing	20	13.0kg	26.0kg	0.09	480x360x540mm
Uni.	1	0.65kg	1.30kg	0.05	260x100x340mm
10.307	Graphic Size: A4				

DAGANZO LED WRITING BOARD



DISPLAY DETAILS



INFORMATION

This portable and retractable display for interchangeable graphics is made of aluminium and plastic parts. It is available in 2 sizes: A3 and A4. Ideal for promoting, special offers or for promoting business.



REF 10.787



REF 10.786

	QTY	N.W	G.W	C.B.M	SIZE
Packing	50	15kg	17kg	0.0656	525x250x500mm
Uni.	1	0.3kg	0.4kg	0.001	90x45x260mm
10.787	Graphic Size: A4				
	QTY	N.W	G.W	C.B.M	SIZE
Packing	50	17.5kg	19kg	0.0881	705x250x500mm
Uni.	1	0.35kg	0.6kg	0.0014	90x45x345mm
10.786	Graphic Size: A3				

TORRICO MINI ROLL UP



DISPLAY DETAILS



INFORMATION

*mm

Mini Flying Banner with steel base and fiberglass flag pole. It is recommendable to print the graphic part on textile. Ideal for promotional use on counters or desks. Graphic printing not included.



	QTY	N.W	G.W	C.B.M	SIZE	
Packing	1	0.30kg	0.35kg	0.0003	30x12x850mm	
10.596	Graphic Size: 550mm (Height)					

KRAKOW
MINI FLYING



DISPLAY DETAILS



INFORMATION

*mm

Mini X-Banner with fiberglass structure and plastic parts. It offers the possibility of exchanging the graphics easily. Ideal for promotional use on counters or desks.



	QTY	N.W	G.W	C.B.M	SIZE	
Packing	200	10kg	14kg	0.07	380x140x500mm	
Uni.	1	0.05kg	0.05kg	0.00045	45x35x285mm	
10.009	Graphic Size: 220x400mm					

TORDESILLAS
MINI X-BANNER



DISPLAY DETAILS



INFORMATION

*mm

Double sided banner display made of durable aluminium and plastic parts. Easy to assemble and graphic change. Carry bag is included. Ideal for trade shows, exhibitions, retail stores or any media event.

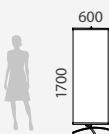

	QTY	N.W	G.W	C.B.M	SIZE
Packing	10	14kg	15kg	0.097	1200x300x270mm
Uni.	1	1.4kg	1.5kg	0.007	85x85x930mm
10.010	Graphic Size: 600x1700mm				

TORMES CROSS BANNER



DISPLAY DETAILS



INFORMATION

*mm

Double sided banner display made of durable aluminium and plastic parts. Easy to assemble and graphic change. Carry bag is included. Ideal for trade shows, exhibitions, retail stores or any media event.

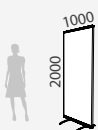

	QTY	N.W	G.W	C.B.M	SIZE
Packing	10	16kg	17kg	0.104	340x240x1280mm
Uni.	1	1.6kg	1.7kg	0.014	120x100x1170mm
10.708	Graphic Size: 1000x2000mm				

ALMEIDA CROSS BANNER



DISPLAY DETAILS

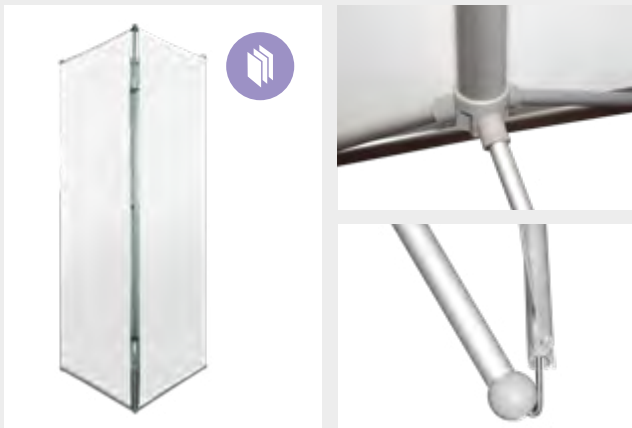

INFORMATION

*mm

Triple sided banner display made of durable aluminium structure and plastic parts. Easy to assemble and change graphics. Carry bag is included.



	QTY	N.W	G.W	C.B.M	SIZE
Packing	5	14kg	16kg	0.064	400x150x1080mm
Uni.	1	2.65kg	3.05kg	0.016	160x160x650mm
10.012	Graphic Size: 915x2150mm (x3)				

GALENDE TRIPLE BANNER



DISPLAY DETAILS



INFORMATION

This display features 4 folding sections for storage with 8 double sided panels (total one side: 2400x1800mm). Included carrying bag for an easy transporting. Grey RAL 9006 color.

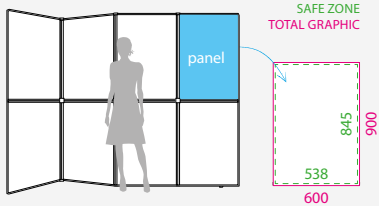

	QTY	N.W	G.W	C.B.M	SIZE
Packing	1	7.3kg	11kg	0.12	640x200x950mm
10.041	Graphic Size: 2400x1800mm				

ARENAS EXHIBITION WALL



DISPLAY DETAILS



DIMENSIONS

*mm

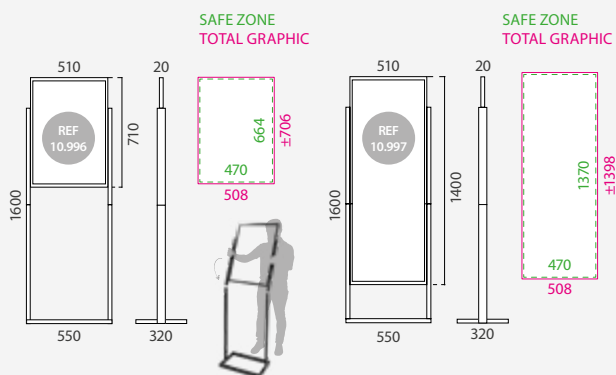
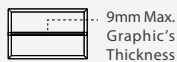
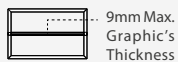

INFORMATION

These solid Displays are made of steel and they are black painted, featuring two different graphic size available. Slide the poster (9mm max. thickness) into the groove and display it back-to-back in high traffic areas.

	QTY	N.W	G.W	C.B.M	SIZE
Packing	1	10.03kg	11.20kg	0.067	570x145x860mm
10.996	Graphic Size: 508 x ±706mm				
	QTY	N.W	G.W	C.B.M	SIZE
Packing	1	11.30kg	12.47kg	0.066	570x145x860mm
10.997	Graphic Size: 508 x ±1398mm				

STEEL STAND DISPLAY



DISPLAY DETAILS



INFORMATION

DIMENSIONS

ARTWORK

*mm

Aluminium Banner Display is lacquered in grey RAL 9006 and features an easy to load and upload system. With an easy glide for the graphic poster (5mm maxi.thickness) into the metal grooves of the structure and display it in high traffic areas. Ideal for displaying at mall's corridors, for promoting at events or trade shows, outside your office or a showroom.

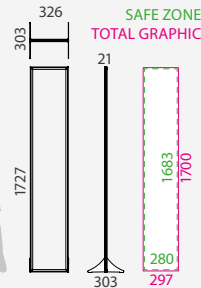

	QTY	N.W	G.W	C.B.M	SIZE
Packing	1	1.8kg	2.32kg	0.0205	1745x335x35mm
13.643	Graphic Size: 297x1700mm				

ALUMINIUM BANNER DISPLAY



DISPLAY DETAILS



INFORMATION

DIMENSIONS

ARTWORK

*mm

Aluminium Stand Display lacquered in gray RAL 9006, featuring an easy to load and upload system. With adjustable stability sturdy feet and an easy glide for the 1400mm height graphic poster (9mm max. thickness) into the metal grooves of the structure and display it back-to-back. Ideal for promoting at trade shows, retail stores, fair stands, showrooms, travel agencies or offices.

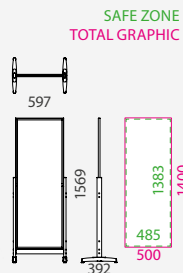

	QTY	N.W	G.W	C.B.M	SIZE
Packing	1	4.47kg	5.54kg	0.0436	880x660x75mm
13.736	Graphic Size: 500x1400mm				

ALUMINIUM STAND DISPLAY



DISPLAY DETAILS



DIMENSIONS

*mm

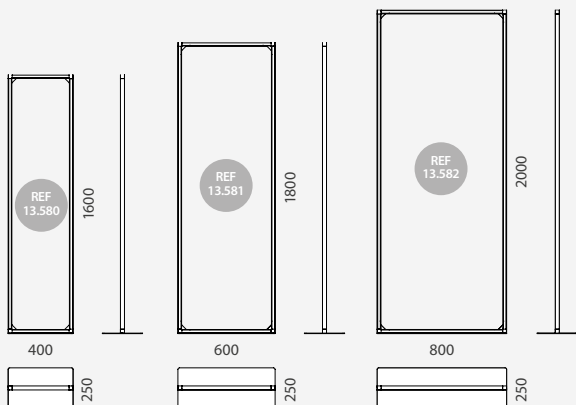

INFORMATION

This closed frame support is made of aluminium and it is suitable for PVC graphic posters, fixed with magnetic tape. Also, it features a stylish and sturdy flat base. Media Frame is ideal for using during a variety of promotional events, such as a trade shows, media events, exhibitions or even as solution for a photocall.

	QTY	N.W	G.W	C.B.M	SIZE
Packing	1	7.5kg	8kg	0.0178	410x860x60mm
13.580	Graphic Size: 400x1600mm				
	QTY	N.W	G.W	C.B.M	SIZE
Packing	1	10kg	11kg	0.0295	610x950x60mm
13.581	Graphic Size: 600x1800mm				
	QTY	N.W	G.W	C.B.M	SIZE
Packing	1	13kg	14kg	0.0436	1070x810x60mm
13.582	Graphic Size: 800x2000mm				

MEDIA FRAME



* PVC sheet and magnetic tape not included.

VILAMOURA EXTENSION BANNER

DISPLAY DETAILS

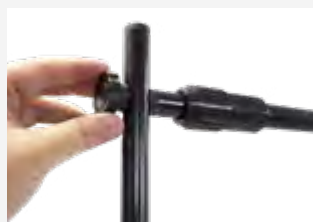

DIMENSIONS

ARTWORK *mm

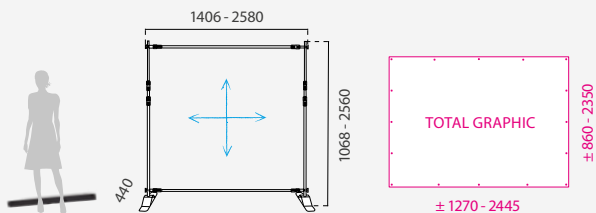

INFORMATION

With structure made of steel and black laquered. This portable banner is ideal for using during a variety of promotional events, such as a trade show, media event, tradeshow exposition or even as solution for a photocall. Vilamoura banner is a display fast to assemble and easy to transport. Each pipe is also designed for an easy and fast telescopic adjustment of the display, allowing the use of graphs of different widths and heights. Minimum graphic size: \pm Height 860 x Width 1270mm. Maximum graphic size: \pm Height 2350 x Width 2445mm.



	QTY	N.W	G.W	C.B.M	SIZE
Packing	2	11kg	12kg	0.031	130x170x1380mm
Uni.	1	5.5kg	6kg	0.015	70x170x1380mm
10.498		Graphic Size: 1270-2445x860-2350mm			

DISPLAY DETAILS



DIMENSIONS

ARTWORK

*mm

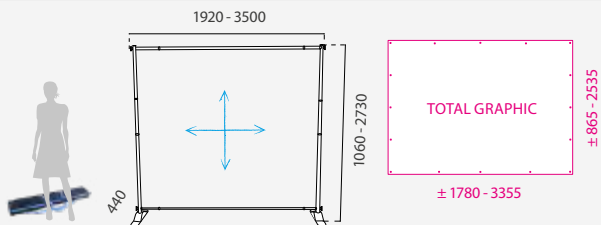

INFORMATION

With structure made of aluminium and plastic. Available black or silver finishing. This portable banner is ideal for using during a variety of promotional events, such as a trade show, tradeshow exposition or even as solution for a photocall. Vilamoura XXL banner is a big size display fast to assemble and easy to transport, ideal for any promotional event that your business requires. Each pipe is also designed for an easy and fast telescopic adjustment of the display, allowing the use of graphs of different widths and heights. Minimum graphic size: \pm Height 865 x Width 1780mm. Maximum graphic size: \pm Height 2535 x Width 3355mm.

VILAMOURA XL EXTENSION BANNER



	QTY	N.W	G.W	C.B.M	SIZE
Packing	1	7kg	8.1kg	0.0266	230x110x1050vmm
13.752			Graphic Size: 1780-3355x865-2535mm		

DISPLAY DETAILS



INFORMATION DIMENSIONS ARTWORK *mm

This double sided Poster Display is made of metal, suitable for 2 exhibitions of graphics. It features a telescopic pole (adjustable height of 1000-1600mm).

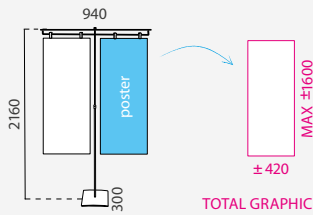

	QTY	N.W	G.W	C.B.M	SIZE	
Packing	1	1.2kg	1.6kg	0.02	270x70x1200mm	

10.803 Graphic Size: $\pm 420 \times 1000-1600 \text{mm}$ (x2)

ALGORA



DISPLAY DETAILS



INFORMATION DIMENSIONS ARTWORK *mm

Oropesa Poster Display is made of metal, featuring a special design for an optimum storage. Also, it has a telescopic pole with adjustable height (1100-2100mm). Ideal for promoting your business, such as tradeshow and promotional events at stores or business presentations.

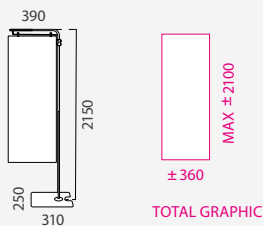

	QTY	N.W	G.W	C.B.M	SIZE	
Packing	1	1.96kg	2.53kg	0.05	410x118x1185mm	

10.432 Graphic Size: $\pm 360 \times 1100-2100 \text{mm}$

OROPESA



DISPLAY DETAILS



INFORMATION

*mm

This portable and detachable display stand features a water refillable base, 6 litres capacity. Made of fiberglass, plastic and lacquered aluminium. Suitable for indoor and outdoor use, features an easy interchange of graphics. Carry bag is included.

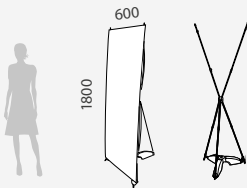

	QTY	N.W	G.W	C.B.M	SIZE	
Pole	1	0.55kg	0.6kg	0.004	80x65x750mm	
Base	1	0.95kg	1kg	0.015	250x170x350mm	
10.028	Graphic Size: 600x1800mm					

ALMAZAN



DISPLAY DETAILS



INFORMATION

*mm

This portable and detachable display stand features a water refillable base, 6 litres capacity. Made of fiberglass, plastic and lacquered aluminium. Suitable for indoor and outdoor use, features an easy interchange of graphics and adjustable height (telescopic). Carry bag is included.

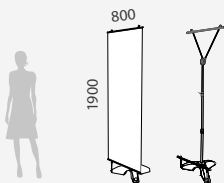

	QTY	N.W	G.W	C.B.M	SIZE	
Packing	6	13kg	16.20kg	0.1	400x320x850mm	
Uni.	1	1.8kg	2.2kg	0.02	240x100x840mm	
10.029	Graphic Size: 800x1900mm					

ALMENAR



DISPLAY DETAILS

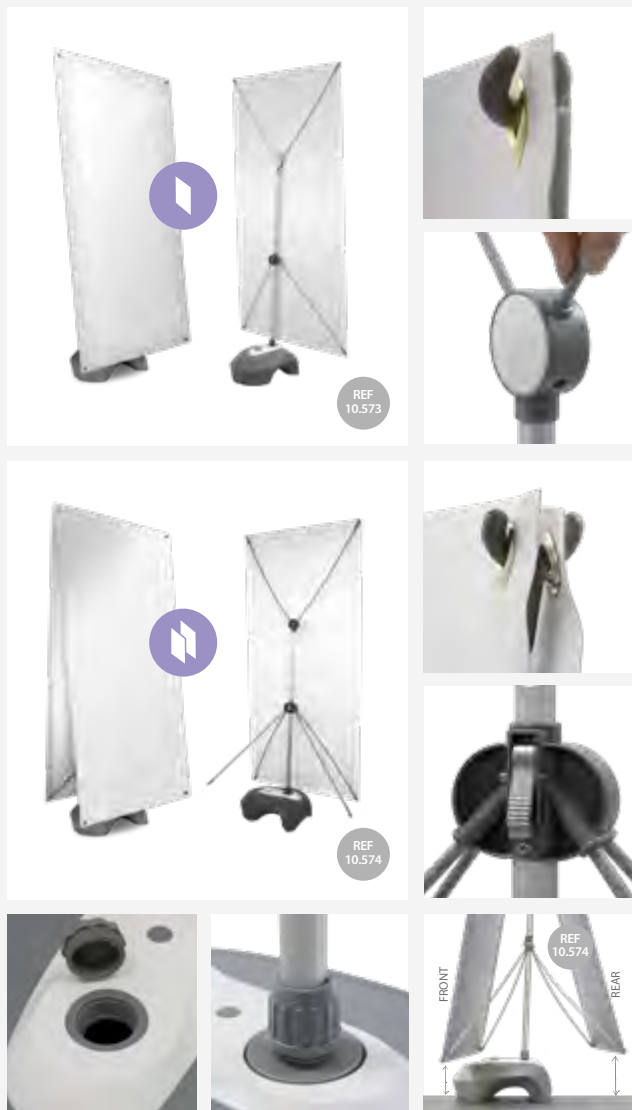

INFORMATION

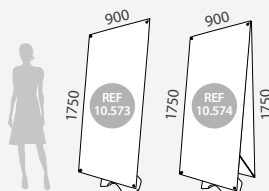

*mm

This stand display features a 20l water refillable base. The central telescopic hub allows fast height adjustment. Kiel is ideal for indoor or outdoor promotion, and as it can be used to present a double-sided graphic (ideal for areas with 2-ways traffic). Graphics are held with a simple and fast eyelet system. In double-sided Kiel 10.574, after the placement of graphs, the distance to the ground on both sides can differentiate each other: ± 50 mm.





KIEL



	QTY	N.W	G.W	C.B.M	SIZE	
Packing	1	2.8kg	3.25kg	0.09	400x200x1080mm	 

10.573 Graphic Size: 900x1750mm

	QTY	N.W	G.W	C.B.M	SIZE	
Packing	1	3kg	3.45kg	0.09	400x200x1080mm	 

10.574 Graphic Size: 900x1750mm x2

DISPLAY DETAILS



INFORMATION

*mm

Medinaceli is a detachable stand display with a refillable 12L water plastic base which is suitable for indoor and outdoor use. The change of graphic is simple and takes only a few seconds. Includes a nylon Carry Bag for an easy transport and storing.

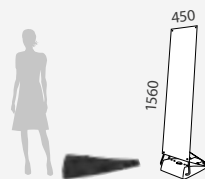

	QTY	N.W	G.W	C.B.M	SIZE
Packing	2	7kg	8.6kg	0.11	540x190x1050mm
Uni.	1	2.85kg	3.50kg	0.05	500x100x1030mm

10.026 Graphic Size: 450x1560mm

MEDINACELI



BASE DETAILS



INFORMATION

*mm

With a durable design and easy portability, this double-sided base with corrugated plastic insert is ideal for placing outdoors, in areas with high traffic to draw in new customers. The weighted poster holder can be filled with up to 5l of water or sand. This base is available on grey or black color.

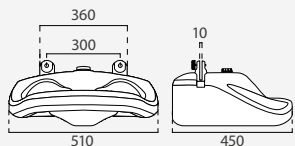

	QTY	N.W	G.W	C.B.M	SIZE
Packing	1	2kg	2.55kg	0.04	440x190x520mm
10.442		Distance Between Holes: 300mm			
10.443					

PANELFIX WING
OUTDOOR



* Board are available but not included. The price includes only the base.

BASE DETAILS



INSTALL EXPLANATION FOR PANELS UP TO 18mm

1. Place the profile below.
2. Adjust the profile with wheel at the bottom of the PanelFix Wing Aluminium.
3. Max. thickness: 18mm.
4. Place the graphic panel into the slot and adjust it with the wheel until it is properly fixed.

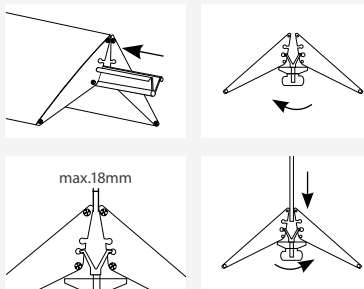

INSTALL EXPLANATION FOR PANELS UP TO 26mm

1. Place the profile above.
2. Adjust the profile with wheel at the bottom of the PanelFix Wing Aluminium.
3. Max. thickness: 26mm.
4. Place the graphic panel into the slot and adjust it with the wheel until it is properly fixed.

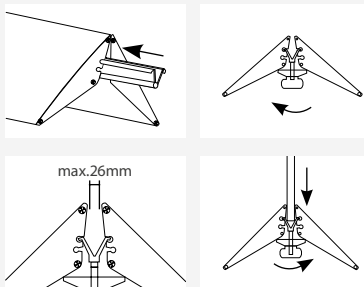

INFORMATION

The PanelFix Wing base made of aluminium is available in three sizes 200, 350 or 550mm and two colors: black or silver. It is designed to hold rigid graphs, allowing the fixing of supports up to 26mm thickness. Also, it allows the printing of any logo on both sides of the base. The double-sided signs help to draw more potential customer coming from both directions into your business.

	QTY	N.W	G.W	C.B.M	SIZE
Packing	1	1.1kg	1.5kg	0.0069	315x93x235mm
10.828		Width: 200mm			
10.829					
	QTY	N.W	G.W	C.B.M	SIZE
Packing	1	2.6kg	3kg	0.0113	315x93x385mm
10.877		Width: 350mm			
10.869					
	QTY	N.W	G.W	C.B.M	SIZE
Packing	1	4.15kg	4.6kg	0.0171	315x93x585mm
10.880		Width: 550mm			
10.870					

PANELFIX WING ALUMINIUM



BASE DETAILS



DIMENSIONS

*mm

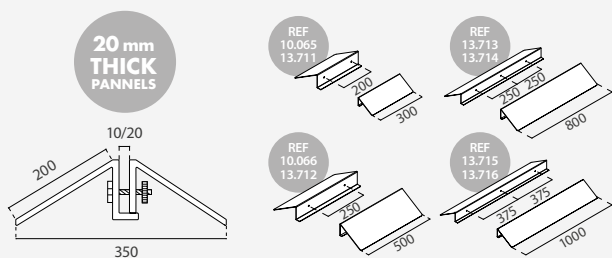

INFORMATION

The Panelfix Wing is a display base made of steel with four available sizes from 300 up to 1000mm and two colors for each size: black or gray. It is designed to hold rigid graphs, allowing the fixing of supports up to 20mm thickness (the max. recommended height is 1500mm). Also, it allows the printing of any logo on both sides of the base. The double-sided signs help to draw more potential customer coming from both directions into your business. The steel base of this sign holder are sturdy enough for multiple uses and years to come, from a crowded trade show floor to a fast paced retail store.

	QTY	N.W	G.W	C.B.M	SIZE
Packing	1	2.75kg	2.95kg	0.0069	210x100x330mm
10.065		Grey	Width: 300mm		
13.711		Black			
	QTY	N.W	G.W	C.B.M	SIZE
Packing	1	4.55kg	4.85kg	0.0111	530x210x100mm
10.066		Grey	Width: 500mm		
13.712		Black			
	QTY	N.W	G.W	C.B.M	SIZE
Packing	1	7.15kg	7.95kg	0.0243	830x255x115mm
13.713		Grey	Width: 800mm		
13.714		Black			
	QTY	N.W	G.W	C.B.M	SIZE
Packing	1	8.85kg	9.85kg	0.0302	1030x255x115mm
13.715		Grey	Width: 1000mm		
13.716		Black			

PANELFIX WING STEEL



* Boards are available but not included. The price includes only the base.

BASE DETAILS



DIMENSIONS

*mm

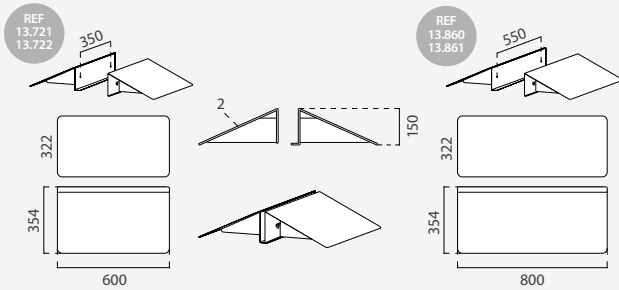

INFORMATION

This base is made of steel sheet of 2mm thickness and it is available in two widths (600 mm and 800mm). It features black laquered (RAL 9005) or grey laquered (RAL 9006). The XL Steel base is ideal to hold rigid materials up to 19mm thickness. The maximum recommended height for the graphic board is 2000mm. Specially designed for supporting big graphic panels thanks to its weight. This base is a simple clip holder system that grips a board between the two sides to help businesses advertise their products and services. Ideal as a sleek, professional alternative to bulky A-frame Board poster stands.

	QTY	N.W	G.W	C.B.M	SIZE
Packing	1	11.85kg	12.55kg	0.0486	400x190x640mm
13.721		Grey		600x663x150mm	
13.722		Black			
	QTY	N.W	G.W	C.B.M	SIZE
Packing	1	14.25kg	15kg	0.064	400x190x840mm
13.860		Grey		800x663x150mm	
13.861		Black			

PANELFIX WING STEEL XL



* Boards are available but not included. The price includes only the base.

BASE DETAILS

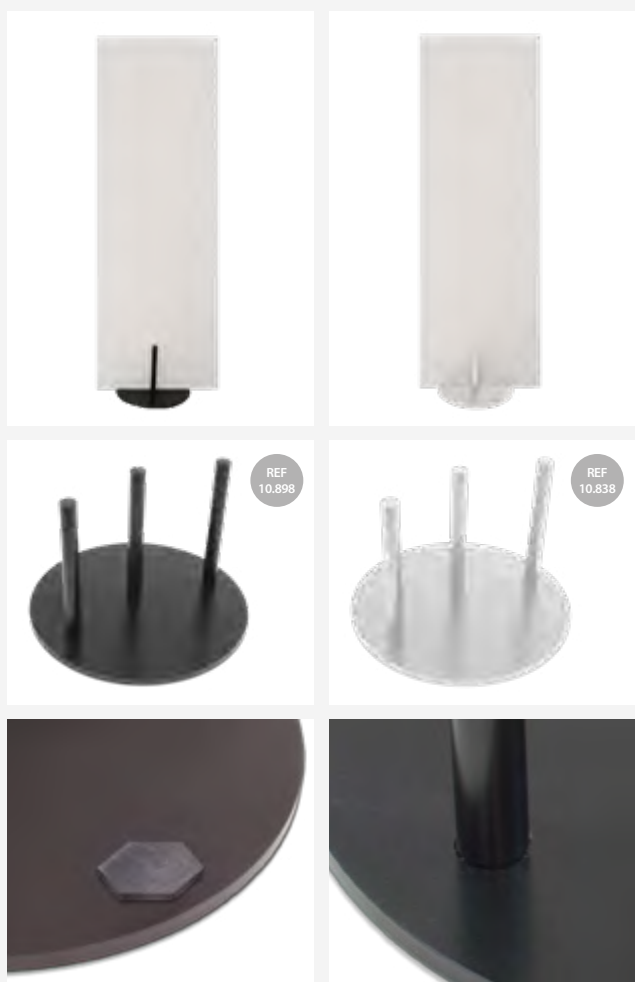

DIMENSIONS

*mm

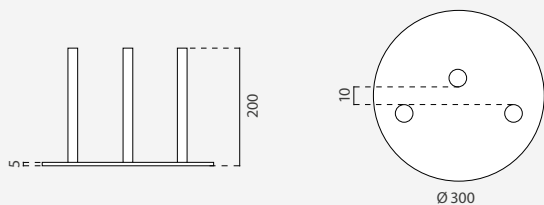

INFORMATION

The Montijo Poster Display is a Ø300mm base made of 5mm thickness steel sheet. It is 200mm height and is available in black or white colored. It is ideal for holding rigid materials of 10mm thickness and includes anti-scratch felt pads at bottom. The double-sided signs help to draw more potential customer coming from both directions into your business. The steel base of this sign holder are sturdy enough for multiple uses and years to come, from a crowded trade show floor to a fast paced retail store.

	QTY	N.W	G.W	C.B.M	SIZE
Packing	2	7.2kg	7.75kg	0.024	310x250x310mm
10.898	<input checked="" type="checkbox"/>	Size: Ø300x200mm		x2	
10.838	<input type="checkbox"/>				

MONTIJO



* Boards are available but not included. The price includes only the base.

BASE DETAILS

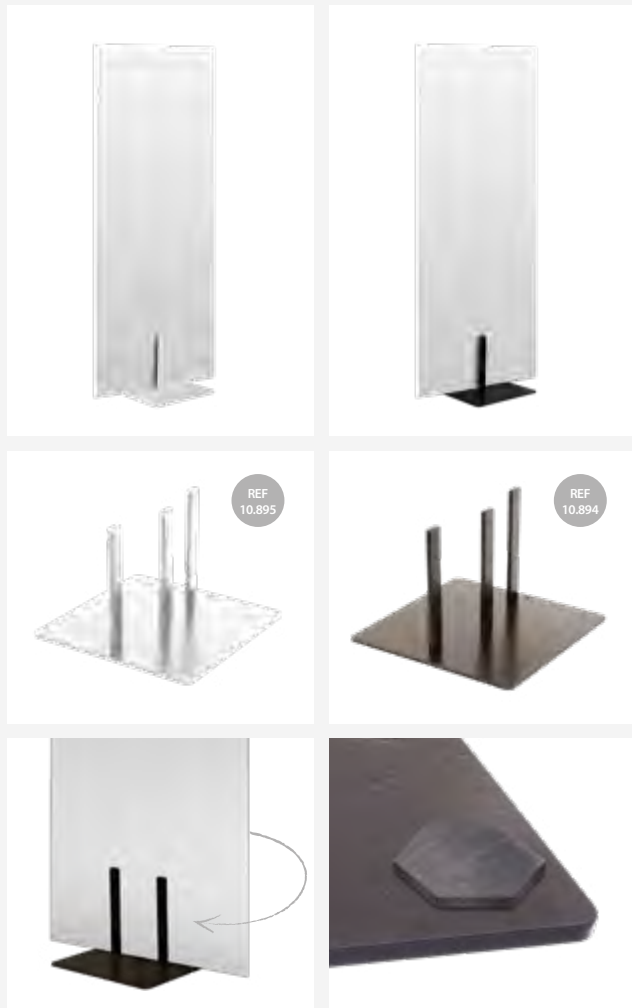

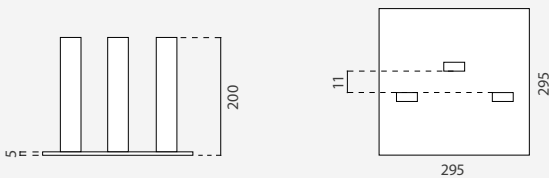

DIMENSIONS *mm



INFORMATION

The Balboa Poster Display is a 295x295mm base and is made of 5mm thickness steel sheet. It features anti-scratch felt pads at bottom. It is 200mm height and is available in black or white colored. This base is suitable for holding rigid materials of 11mm thickness. The steel base of this sign holder are sturdy enough for multiple uses and years to come, from a crowded trade show floor to a fast paced retail store.

	QTY	N.W	G.W	C.B.M	SIZE
Packing	2	9.00kg	9.60kg	0.024	310x250x310mm
10.894		295x200x295mm		x2	
10.895					

BALBOA



* Boards are available but not included. The price includes only the base.

BASE DETAILS

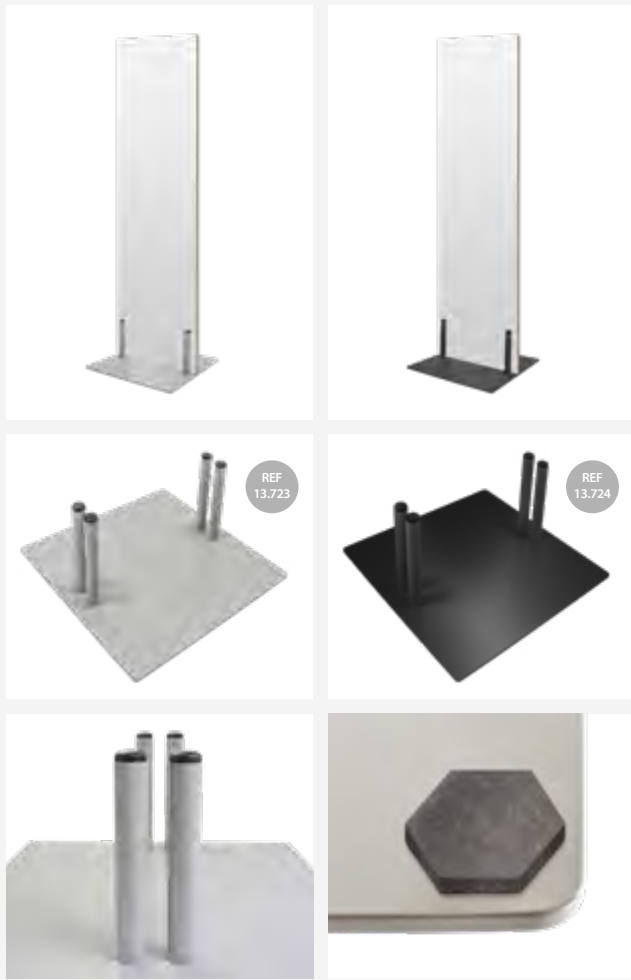

DIMENSIONS

*mm

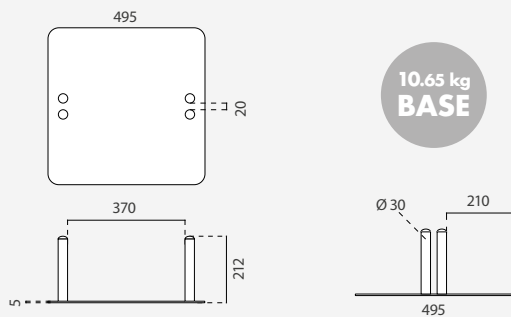

INFORMATION

The Balboa XL is made of steel sheet of 5mm thickness. It features black laquered (RAL 9005) or grey laquered (RAL 9006) finish. This XL Steel base is ideal to hold rigid materials of 19mm thickness. Specially designed for supporting big graphic panels (2000mm max. height recommended) thanks to its 10.65kg.

	QTY	N.W	G.W	C.B.M	SIZE
Packing	1	11.30kg	12.10kg	0.0772	545x545x260mm
13.723		Grey	495x212x495mm		
13.724		Black			

BALBOA XL



* Boards are available but not included. The price includes only the base.

SIDEWALK DETAILS



SIDEWALK DETAILS

GRAPHIC BY CLICK FRAME



DIMENSIONS * W: Width H: Height D: Depth *mm UTILITIES

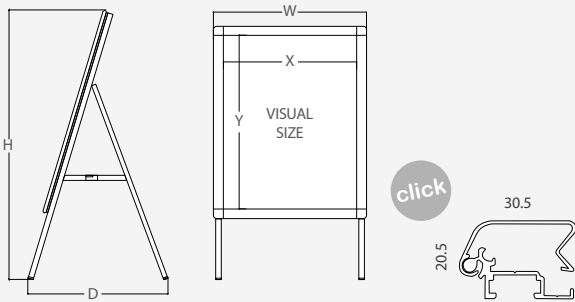

INFORMATION

This frame board is made of aluminum so it is lightweight and resistant to rusting. It has a 30.5mm width profile with click system, so the graphic change is quick and simple. With its single-sided folding frame, Niza A-Board is ideal for advertising outside your store, like restaurants, street stalls or supermarkets. It includes a weather resistant antireflection protector so is also non-glare which allows it to be read under bright lights.

	QTY	N.W	G.W	C.B.M	Size (WxHxD)
Packing	1	5kg	7kg	0.075	580x1080x120
		Visual (X-Y)	External (WxHxD)		
Product	485x685		540x1060x440		
10.808		Graphic Size: 500x700mm			

NIZA



SIDEWALK DETAILS



DIMENSIONS * W: Width H: Height D: Depth * mm UTILITIES

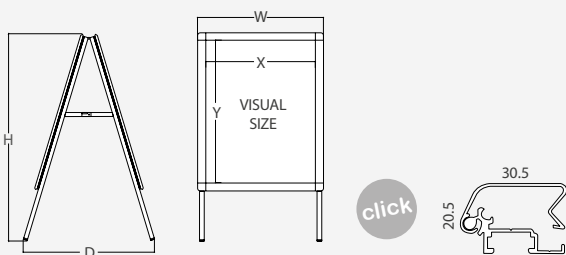

INFORMATION

Bayonne Sidewalk is made of aluminum so it is lightweight and resistant to rusting. It has feet protection to avoid slipping and a 30.5mm width profile with click system, so the graphic change is fast and simple. Also, it includes a weather resistant antireflection sheet so is also non-glare which allows it to be read under bright lights. With its 2-sided folding frame, The Bayonne Sidewalk is ideal for advertising sales inside or outside your store.

	QTY	N.W	G.W	C.B.M	Size (WxHxD)
Packing	1	4.85kg	6.5kg	0.068	509x1120x120
		Visual (X-Y)	External (WxHxD)		
Product	485x685		545x1030x532		

10.804 Graphic Size: 500x700mm

	QTY	N.W	G.W	C.B.M	Size (WxHxD)
Packing	1	7.64kg	9.6kg	0.127	795x1400x115
		Visual (X-Y)	External (WxHxD)		
Product	687x988		745x1330x605		

10.805 Graphic Size: 700x1000mm

	QTY	N.W	G.W	C.B.M	Size (WxHxD)
Packing	1	6.7kg	8.5kg	0.101	695x1220x120
		Visual (X-Y)	External (WxHxD)		
Product	580x830		640x1170x540		

13.145 Graphic Size: A1

	QTY	N.W	G.W	C.B.M	Size (WxHxD)
Packing	1	11kg	12.5kg	0.176	930x1575x120
		Visual (X-Y)	External (WxHxD)		
Product	825x1170		885x1520x585		

13.146 Graphic Size: A0

BAYONNE



ANTIREFLECTION SHEET

- EN Antireflection sheet for snapframe.
- FR Antireflet pour cadres ou chevalets.
- PT Película antirreflexo para marcos e cavaletes.
- ES Antireflex para marcos y caballetes.



SIZE

10.952	500x700mm
10.953	700x1000mm
10.992	A1 598x838mm
10.993	A0 838x1188mm

SIDEWALK DETAILS

GRAPHIC BY CLICK FRAME



INFORMATION

* W: Width H: Height D: Depth * mm

UTILITIES

Grenoble is a small size A-frame aluminium board. It has a 32mm click system profile and includes a weather resistant antireflection protector. Lightweight and resistant to rusting.

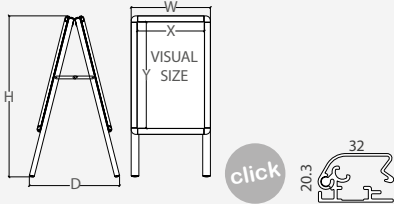

	QTY	N.W	G.W	C.B.M	Size (WxHxD)
Packing	1	4.3kg	5kg	0.0374	425x880x100
		Visual (X-Y)	External (WxHxD)		
Product	344x544	404x815x456			
10.942	Graphic Size: 360x560mm				

GRENOBLE



SIDEWALK DETAILS

GRAPHIC BY CLICK FRAME

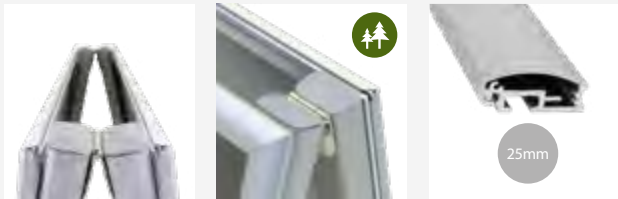

INFORMATION

* W: Width H: Height D: Depth * mm

UTILITIES

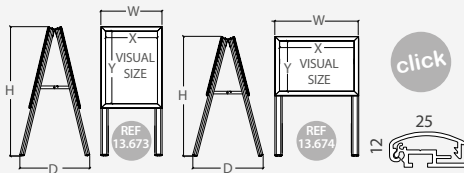

Poisat is a small dimensions aluminium A-frame Board. It is lightweight and resistant to rusting. It has a 25mm width click system profile. It includes a weather resistant antireflection protector. Ideal for advertising your upcoming events, shows, menu or last offers at your show window.

	QTY	N.W	G.W	C.B.M	Size (WxHxD)
Packing	1	2.77kg	3.298kg	0.0244	340x715x85
		Visual (X-Y)	External (WxHxD)		
Product	279x402	332x699x379			
13.673	Graphic Size: A3 Portrait				

	QTY	N.W	G.W	C.B.M	Size (WxHxD)
Packing	1	2.63kg	3.257kg	0.0308	460x670x85
		Visual (X-Y)	External (WxHxD)		
Product	279x402	455x648x381			
13.674	Graphic Size: A3 Landscape				

POISAT



SIDEWALK DETAILS

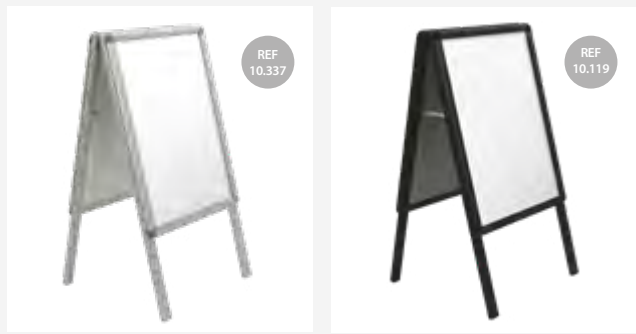

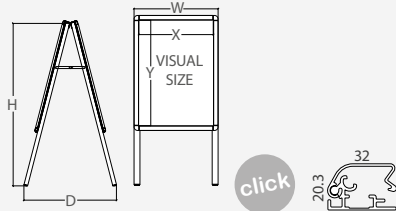

INFORMATION * W: Width H: Height D: Depth * mm UTILITIES

Merida has a 32mm width aluminium profile with click system, so it is lightweight and resistant to rusting. It has feet protections to avoid slipping and a weather resistant antireflection protector.



RAL COLORS AVAILABLE

-  Ral 3020
-  Ral 5005
-  Ral 6029
-  Wood Color

	QTY	N.W	G.W	C.B.M	Size (WxHxD)
Packing	1	7.92kg	9.69kg	0.098	660x1420x105
		Visual (X-Y)	External (WxHxD)		
Product	575x822	638x1400x698		GRAPHIC SIZE	
10.337					
10.119	   			A1	
10.119WD					
	QTY	N.W	G.W	C.B.M	Size (WxHxD)
Packing	1	5.64kg	6.7kg	0.072	575x1100x115
		Visual (X-Y)	External (WxHxD)		
Product	481x681	544x1050x598		GRAPHIC SIZE	
10.338					
10.122	   			500x700mm	
10.122WD					
	QTY	N.W	G.W	C.B.M	Size (WxHxD)
Packing	1	8.94kg	10.67kg	0.127	765x1445x115
		Visual (X-Y)	External (WxHxD)		
Product	681x981	744x1400x799		GRAPHIC SIZE	
10.339					
10.124	   			700x1000mm	
10.124WD					



SIDEWALK DETAILS * W: Width H: Height D: Depth *mm UTILITIES

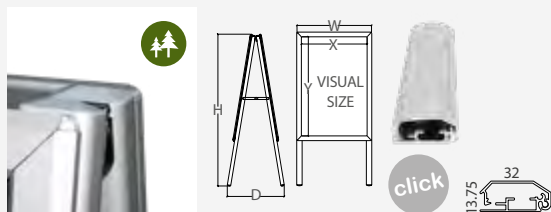

INFORMATION

The Dijon Sidewalk is designed for outdoor use so it's perfect for advertising outside or inside your store. It has a 32mm width aluminium profile with click system, so the graphic change is quick and simple. It includes a weather resistant antireflection protector. Thanks to its double-sided frame is ideal for displaying offers, menus, information maps, etc.

	QTY	N.W	G.W	C.B.M	Size (WxHxD)
Packing	1	5kg	6.5kg	0.0877	580x1120x135
		Visual (X-Y)	External (WxHxD)		
Product	478x678	542x1038x414			
10.558	Graphic Size: 500x700mm				
	QTY	N.W	G.W	C.B.M	Size (WxHxD)
Packing	1	6.4kg	8.5kg	0.0984	660x1420x105
		Visual (X-Y)	External (WxHxD)		
Product	572x819	636x1382x536			
10.557	Graphic Size: A1				
	QTY	N.W	G.W	C.B.M	Size (WxHxD)
Packing	1	7.9kg	9.65kg	0.1562	790x1465x135
		Visual (X-Y)	External (WxHxD)		
Product	678x978	742x1382x536			
10.559	Graphic Size: 700x1000mm				

DIJON



SIDEWALK DETAILS

GRAPHIC BY CLICK FRAME

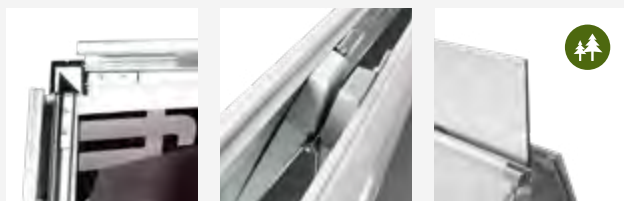

INFORMATION * W: Width H: Height D: Depth *mm UTILITIES

This double-sidewalk is made of aluminum so it is lightweight and resistant to rusting. It has a 21mm width click system profile. It features a headboard support for displaying a graphic. It includes a weather resistant antireflection protector. Ideal for using outside or inside your store, restaurant, street stall or supermarket.

	QTY	N.W	G.W	C.B.M	Size (WxHxD)
Packing	1	13.9kg	15.7kg	0.1085	690x1210x130
		Visual (X-Y)	External (WxHxD)		
Product	581x828	647x1160x625			
10.235	Graphic Size: A1				

BELMEZ



SIDEWALK DETAILS



DIMENSIONS * W: Width H: Height D: Depth *mm **UTILITIES**

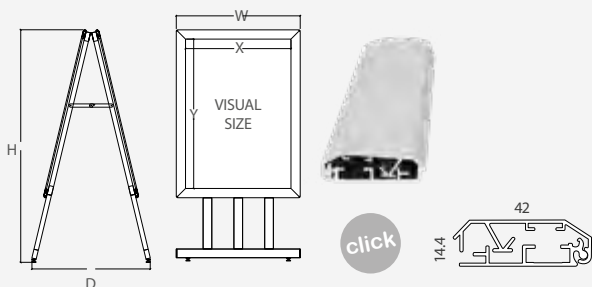

INFORMATION

Montanchez Sidewalk features and structure made of aluminum over a steel structure so this way, its extra weight gives a great stability and it's very resistant to rusting. It has non-slip leveling feet and also a 42mm width profile with click system, so the graphic change is quick and simple. It includes a weather resistant antireflection protector, so is also non-glare, which allows it to be read under the bright lights. With its double-sided folding frame, Montanchez is designed especially for outdoor use so it's perfect for advertising sales and promotions outside your store.

	QTY	N.W	G.W	C.B.M	Size (WxHxD)
Packing	1	11.95kg	13.1kg	0.070	560x1090x115
		Visual (X-Y)	External (WxHxD)		
Product	480x660		564x1052x524		
10.127	Graphic Size: 500x700mm				

	QTY	N.W	G.W	C.B.M	Size (WxHxD)
Packing	1	17.25kg	19.3kg	0.121	880x1375x100
		Visual (X-Y)	External (WxHxD)		
Product	680x960		764x1402x525		
10.128	Graphic Size: 700x1000mm				

	QTY	N.W	G.W	C.B.M	Size (WxHxD)
Packing	1	25.5kg	28.5kg	0.1886	1100x1805x98
		Visual (X-Y)	External (WxHxD)		
Product	980x1360		1064x1802x566		
10.129	Graphic Size: 1000x1400mm				

MONTANCHEZ



SIDEWALK BOARDS



Click Boards

SIDEWALK DETAILS



SIDEWALK DETAILS

GRAPHIC BY CLICK FRAME



DIMENSIONS

* W: Width H: Height D: Depth *mm

UTILITIES

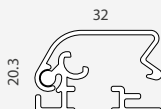
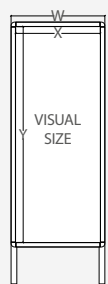
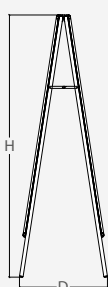

INFORMATION

The Poznan A-board frame is made of aluminum so it is lightweight and resistant to rusting and it is available on black or silver color. It has a 32mm width profile with click system, so the graphic change is quick and simple. It includes a weather resistant antireflection protector which allows it to be read under bright lights. Thanks its double-sided frame and its 1800mm height this A-Board is ideal for advertising large offers, menus, information maps, etc, outside or inside your business.

	QTY	N.W	G.W	C.B.M	Size (WxHxD)
Packing	1	12.9kg	14.8kg	0.177	705x1860x135
		Visual (X-Y)	External (WxHxD)		
Product	581x1481		644x1800x600		
10.343		Graphic Size: 600x1500mm			

POZNAN





SIDEWALK DETAILS



DIMENSIONS * W: Width H: Height D: Depth *mm UTILITIES

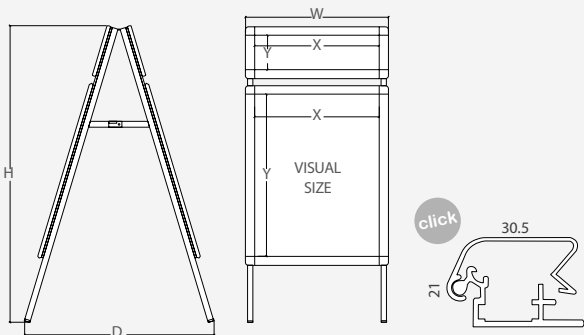

INFORMATION

Toulouse double-Sidewalk is made of aluminum so it is lightweight and resistant. It has a 30,5mm width profile with click system, so the graphic change is quick and simple. Also it includes a resistant antireflection protector which allows it to be read under bright lights. Features a headboard support for displaying company logos or graphs. Ideal for displaying sales or promotions at restaurants, stores, shops or supermarkets.

	QTY	N.W	G.W	C.B.M	Size (WxHxD)
Packing	1	9kg	11kg	0.1010	610x120x1380
	Board Visual (X-Y)	Upper Visual (X-Y)	External (WxHxD)		
Product	485x685	485x185	545x1210x630		
10.806	Board Graphic Size: 500x700mm		Upper Graphic Size: 500x200mm		

TOULOUSE



DISPLAY DETAILS

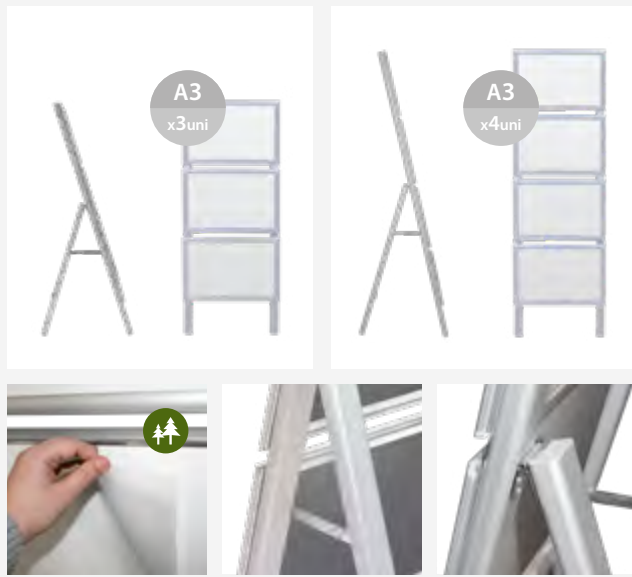

CLICK FRAME PROFILE DETAILS

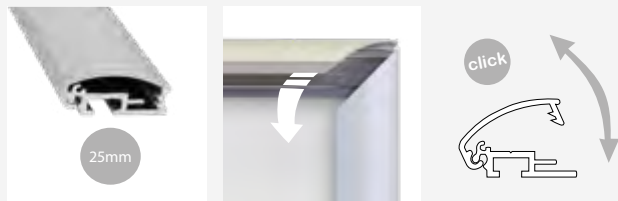

DIMENSIONS * W: Width H: Height D: Depth *mm UTILITIES

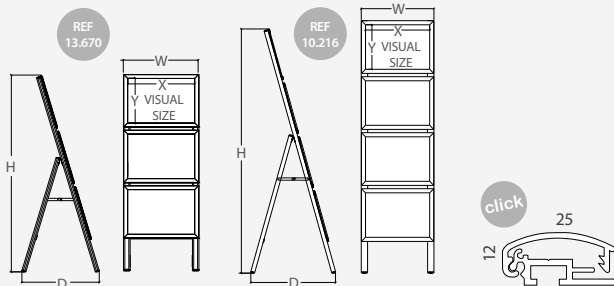

INFORMATION

This anodized aluminium A-Board is very lightweight, foldable for an easy storage and very resistant to rusting. It features a 25mm width profile with click system, so the graphic change is quick and simple. Also it includes a weather resistant antireflection protector. The Mota A-Board range features 2 configurations of A3 frames. They are ideal for advertising sales or special promotions inside or outside your business. It's perfect for restaurants, stalls, stores or for any marketplace.

	QTY	N.W	G.W	C.B.M	Size (WxHxD)
Packing	1	4.2kg	5.218kg	0.0566	475x1255x95
		Visual (X-Y)		External (WxHxD)	
Product	402x279		455x1182x466		
13.670	Graphic Size: A3 x3				
	QTY	N.W	G.W	C.B.M	Size (WxHxD)
Packing	1	5.7kg	6.7kg	0.0722	475x1600x95
		Visual (X-Y)		External (WxHxD)	
Product	402x279		450x1530x490		
10.216	Graphic Size: A3 x4				

MOTA SINGLE-SIDED

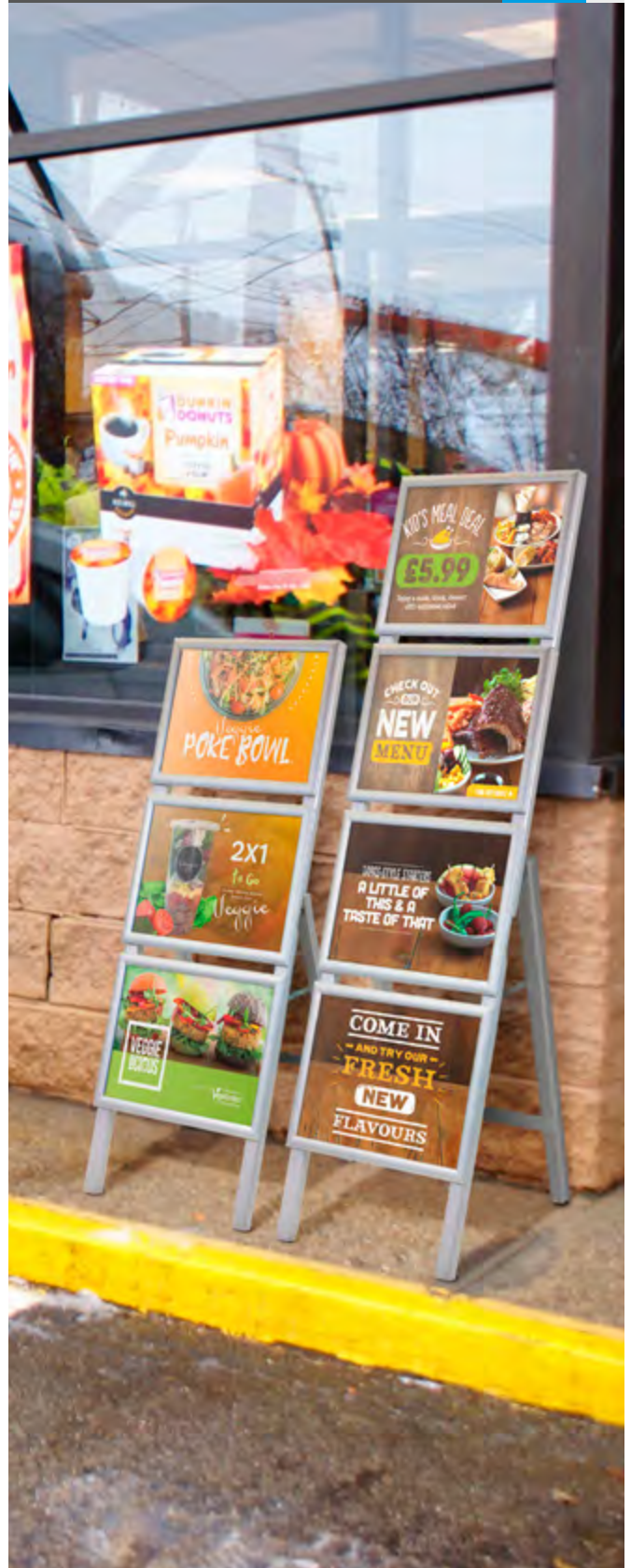



SIDEWALK DETAILS



CLICK FRAME PROFILE DETAILS



DIMENSIONS

* W: Width H: Height D: Depth *mm

UTILITIES

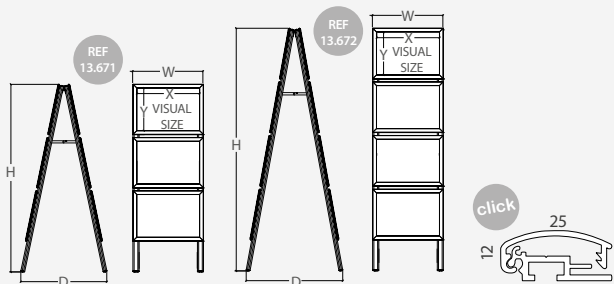

INFORMATION

This anodized aluminium A-Board is very lightweight, foldable for an easy storage and very resistant to rusting. It features a 25mm width profile with click system, so the graphic change is quick and very simple. Also it includes a weather resistant antireflection protector. The Mota A-Board range features 2 configurations of A3 frames. They are ideal for advertising sales or special promotions inside or outside your business.

	QTY	N.W	G.W	C.B.M	Size (WxHxD)
Packing	1	6.4kg	7.418kg	0.0566	475x1255x95
		Visual (X-Y)		External (WxHxD)	
Product	402x279		455x1207x553		

13.671 Graphic Size: A3 3+3

	QTY	N.W	G.W	C.B.M	Size (WxHxD)
Packing	1	8.3kg	9.559kg	0.0722	475x1600x95
		Visual (X-Y)		External (WxHxD)	
Product	402x279		455x1557x619		

13.672 Graphic Size: A3 4+4

MOTA DOUBLE-SIDED

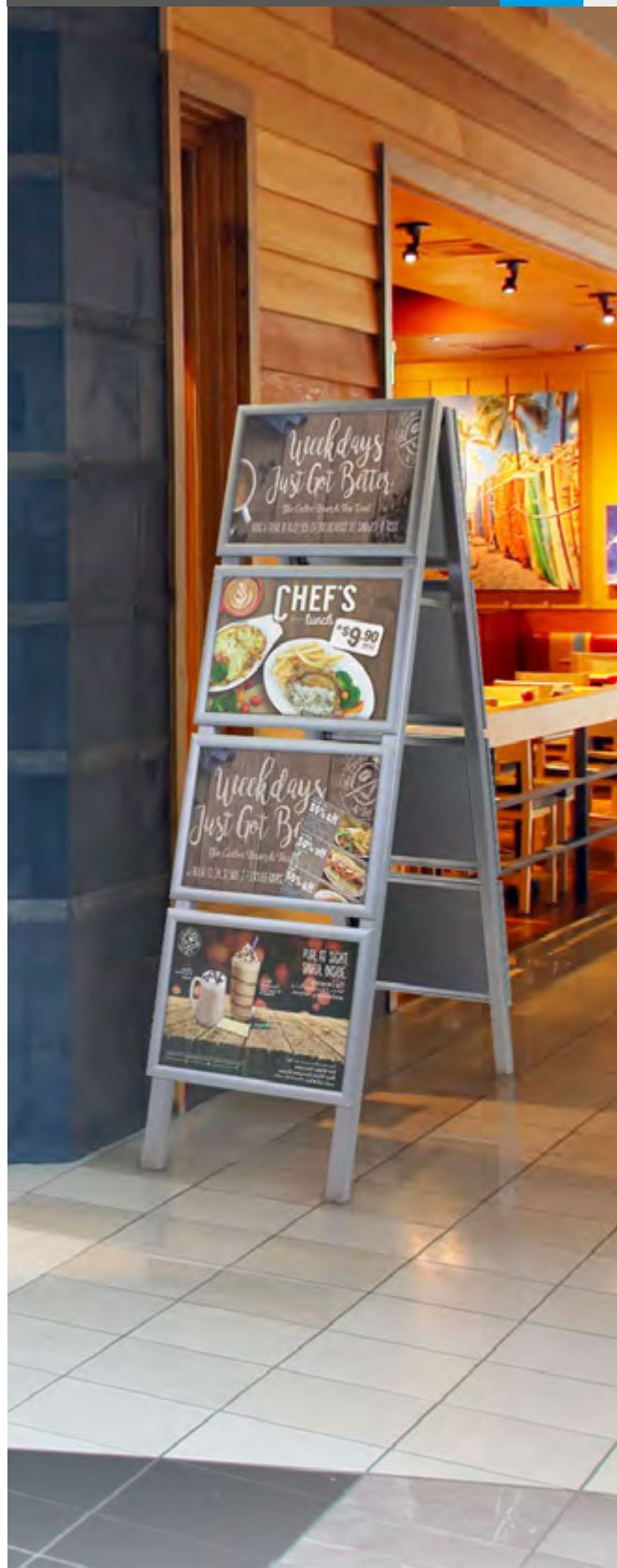

LAMP DETAILS



“ with +6h autonomy rechargeable battery ”



DIMENSIONS

* W: Width H: Height D: Depth * mm

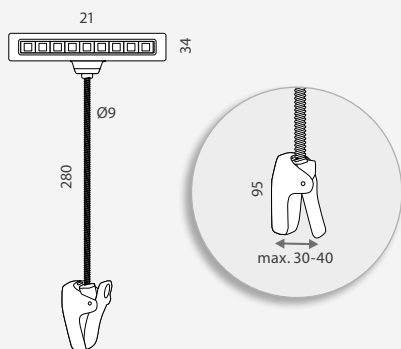

INFORMATION

The Portable and rechargeable 1.8W LED Lamp is a very useful accessory for any display, has an autonomy of more than 6 hours and three levels of brightness (featuring a charging indicator display). With a stunning black finish, this portable LED Lamp will add a touch of distinction and functionality to your display. Thanks to its low consumption and its high strength clamp (3-4cm maximum grip) it can be coupled to a wide range of display products, among them Frame Boards, Blackboards, Photocalls, Lecterns or Counters.

	QTY	N.W	G.W	C.B.M	Size (WxHxD)
Packing	1	0.30kg	0.40kg	0.00174	110x227x70
13.642					

PORTABLE LED LAMP



14.111
A-BOARD SPECIAL TOP
Seen in BLACKBOARDS



13.641
WOODEN FAST LECTERN
LECTERNS
Seen in FRAMES & INFORMATIVE HOLDERS



10.996
STEEL DISPLAY
POSTER DISPLAY
Seen in STAND DISPLAYS

SIDEWALK DETAILS



DIMENSIONS * W: Width H: Height D: Depth *mm **UTILITIES**

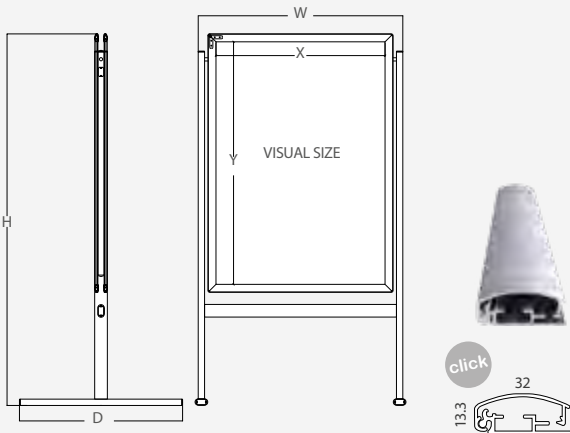

INFORMATION

The Ibahernando Sidewalk is made of aluminum so it is lightweight and resistant to rusting and wind thanks its strong 847mm length feet. It features a 32mm width profile with click system, so the graphic change is fast and simple y a few seconds. Also it features a revolving board design and it includes a resistant antireflection protector so is also non-glare which allows it to be read under bright lights. Ibahernando Sidewalk is ideal for displaying sales or promotions at restaurants, stores, shops or at supermarkets.

	QTY	N.W	G.W	C.B.M	Size (WxHxD)
Packing	1	9.6kg	11.8kg	0.141	875x1535x105
	Visual (X-Y)	External (WxHxD)			
Product	686x986	821x1506x847			
10.165	Graphic Size: 700x1000mm				

IBAHERNANDO

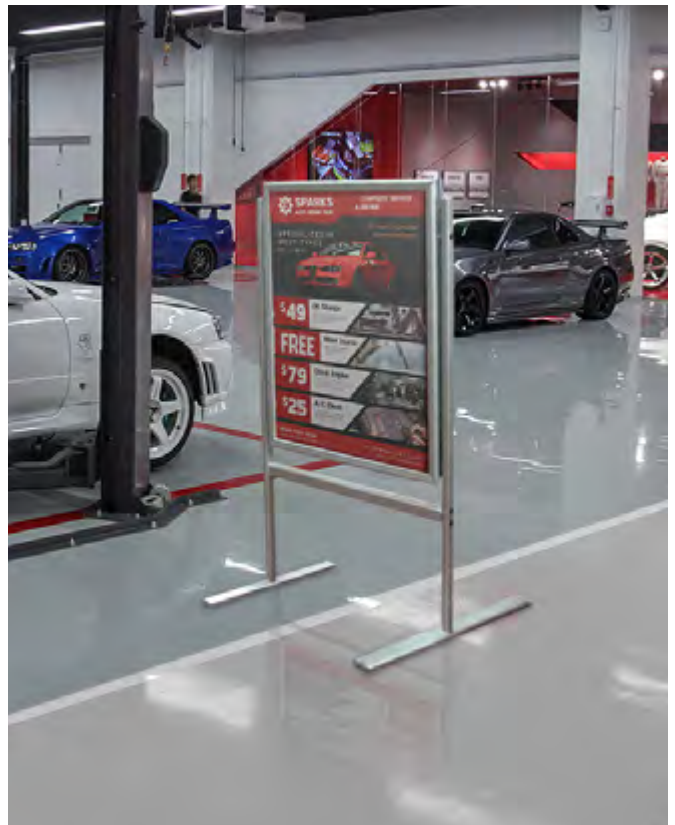

SIDEWALK DETAILS



DIMENSIONS * W: Width H: Height D: Depth *mm **UTILITIES**

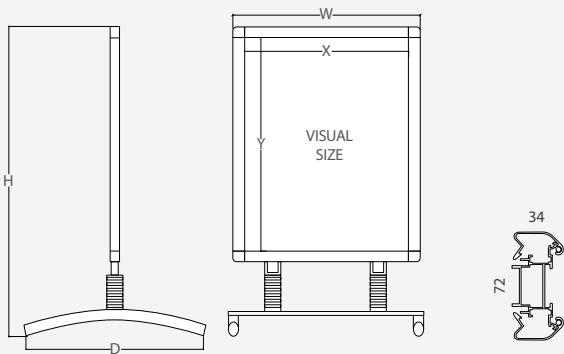

INFORMATION

Boal Sidewalk is made of aluminum and has a strong base and sturdy springboard design which allows flexion in windy conditions. It has a 34mm width profile with click system, so the graphic change is quick and simple. It includes a resistant antireflection protector so is also non-glare which allows it to be read under bright lights. Ideal for displaying outside your event, restaurant, street stall or supermarket for advertising offers or temporary exhibitions.

	QTY	N.W	G.W	C.B.M	Size (WxHxD)	
Packing	1	7.8kg	9.4kg	0.066	750x1100x80	 x2
	1	4.55kg	4.85kg	0.009	140x670x100	
		Visual (X-Y)	External (WxHxD)			
Product	570x815		640x1130x560			
10.166		Graphic Size: 605x860mm				

BOAL



SIDEWALK DETAILS

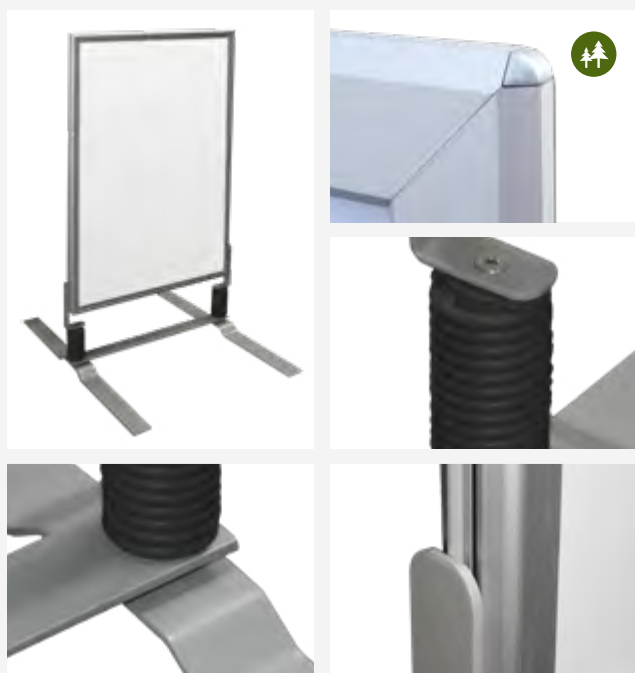

DIMENSIONS * W: Width H: Height D: Depth *mm **UTILITIES**

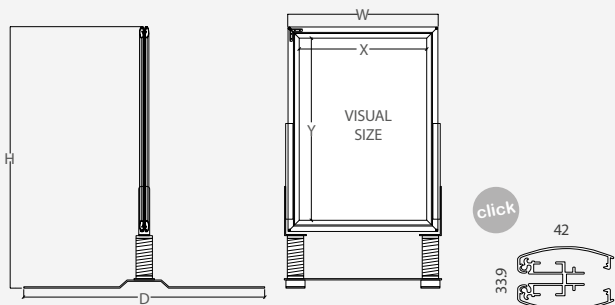

INFORMATION

Hervas Sidewalk is made of aluminum and has a strong base with a wide footprint and sturdy springboard design which allows the flexion in windy conditions. It has a 42mm width profile with click system, so the graphic change is quick and simple. It includes a resistant antireflection protector. Ideal for being used inside or outside your gas station, restaurant, street stall or supermarket for advertising last promotions.

	QTY	N.W	G.W	C.B.M	Size (WxHxD)	
Packing	1	4.2kg	5.05kg	0.0373	965x595x65	 x2
	1	9.35kg	9.5kg	0.0043	1010x77x55	
		Visual (X-Y)	External (WxHxD)			
Product	466x666	575x956x940				

10.161 Graphic Size: 500x700mm

	QTY	N.W	G.W	C.B.M	Size (WxHxD)	
Packing	1	6.75kg	8.45kg	0.0574	785x1125x65	 x2
	1	9.35kg	9.5kg	0.0043	1010x77x55	
		Visual (X-Y)	External (WxHxD)			
Product	666x966	750x1256x940				

10.162 Graphic Size: 700x1000mm

HERVAS



SIDEWALK BOARDS



Click Refillable Base

SIDEWALK DETAILS



DIMENSIONS * W: Width H: Height D: Depth *mm UTILITIES

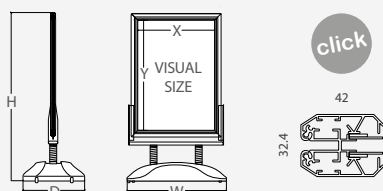

INFORMATION

This waterproof Click Board is designed especially for outdoor use. The heavy-duty, molded plastic base features a screw-in cap and can be filled with 26l of water for 10.341 and 10.115 models and 52l for 10.116 and 10.342. Its 42mm width waterproof profile with click system, provides an easy and quick graphic change (weather resistant antireflection protector included). Built-in wheels also make this board easy to move. To further enhance its stability Arcachon features rugged springs to reduce the impact of wind. Ideal for displaying outside the restaurants, street stall, events, supermarkets or fuel stations.

ARCACHON

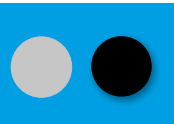

	QTY	N.W	G.W	C. B.M	Size (WxHxD)		
Packing	1 Frame	6.75kg	8.1kg	0.0475	660x900x80		
	1 Base	3.95kg	4.75kg	0.0734	800x180x510		
		Visual (X-Y)	External (WxHxD)				
Product		494x694	780x1103x500				
10.115					Graphic Size: 500x700mm		
	QTY	N.W	G.W	C. B.M	Size (WxHxD)		
Packing	1 Frame	8.1kg	9.2kg	0.0616	740x1040x90		
	1 Base	3.95kg	4.75kg	0.0734	800x180x510		
		Visual (X-Y)	External (WxHxD)				
Product		588x835	780x1254x500				
10.341					Graphic Size: A1		
	QTY	N.W	G.W	C. B.M	Size (WxHxD)		
Packing	1 Frame	9.1kg	10.5kg	0.0745	810x1150x80		
	1 Base	7kg	8.2kg	0.1320	1015x200x650		
		Visual (X-Y)	External (WxHxD)				
Product		694x994	1010x1420x630				
10.116					Graphic Size: 700x1000mm		
	QTY	N.W	G.W	C. B.M	Size (WxHxD)		
Packing	1 Frame	10.25kg	11.60kg	0.1051	980x1340x80		
	1 Base	7kg	8.2kg	0.1320	1015x200x650		
		Visual (X-Y)	External (WxHxD)				
Product		835x1183	1010x1618x630				
10.342					Graphic Size: A0		

SIDEWALK DETAILS



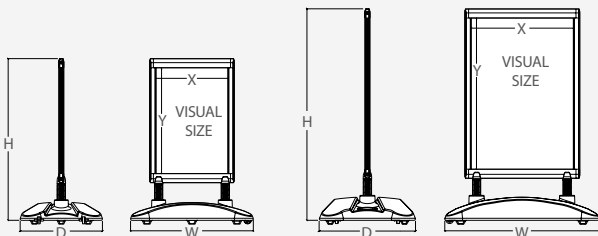

DIMENSIONS

* W: Width H: Height D: Depth * mm





INFORMATION

This Click Board is designed especially for outdoor use. The heavy-duty, molded plastic base features a screw-in cap and can be filled with 26l of water or 52l depending on model. The graphic change is simple thanks its Click System profile (weather resistant antireflection sheet included). Built-in wheels also make this board easy to move as needed. To further enhance its stability Gujan features rugged springs to reduce the impact of wind. Ideal for displaying outside the restaurants, street stall, events, supermarkets or fuel stations.

	QTY	N.W	G.W	C. B.M	Size (WxHxD)	
Packing	1 Frame	6.89kg	7.9kg	0.05	625x85x940	 x2  26L
	1 Base	3.95kg	4.75kg	0.0734	800x180x510	
		Visual (X-Y)	External (WxHxD)			
Product		476x700	780x1094x500			

13.847-1  Graphic Size: 500x700mm

	QTY	N.W	G.W	C. B.M	Size (WxHxD)	
Packing	1 Frame	9.71kg	11.42kg	0.087	825x85x1240	 x2  52L
	1 Base	7kg	8.2kg	0.1320	1015x200x650	
		Visual (X-Y)	External (WxHxD)			
Product		676x1000	1010x1423x630			

13.847-2  Graphic Size: 700x1000mm

GUJAN



ANTIREFLECTION SHEET

EN	Antireflection protector sheet for Click Frames.
FR	Antireflet pour cadres ou chevalets.
PT	Película antireflexo para marcos e cavaletes.
ES	Protector antireflex para marcos y caballetes.

SIZE	
13.836	534x734mm
13.837	735x1034mm
13.838	628x875mm
13.839	875x1223mm





SIDEWALK DETAILS



DIMENSIONS

*mm

UTILITIES

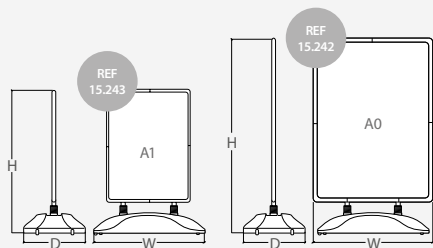

TEXTILE
*Printing on fabric.
Impression sur toile.
Impressão em tecido.
Impresión en tela.

INFORMATION

The Mikonos Sidewalk features a lightweight aluminum structure with a refillable plastic base that assembles in seconds (It is 3.95kg weight and it can be filled with 17l of water or sand). Also, the Textile Boards are also simple to setup. All the aluminium poles fit together and snap into base. Simply stretch the wrap over the completed structure and it's ready to use. The aluminium structure is affixed to the base with 2 large springs, so it stays stable in windy conditions. Built-in wheels also make this board easy to move as needed. A Nylon Carrying bag is included. This Sidewalk is ideal for being used inside or outside of restaurants, workshops, street stalls, supermarkets or heavily-trafficked areas such as tradeshows, events or conventions.

	QTY	N.W	G.W	C.B.M	Size (WxHxD)	
Packing	1	7.5kg	9.5kg	0.11	510x950x230	17L
	Visual (X-Y)		External (WxHxD)			
Product	A1 (665x915mm)		770x1120x480mm			
15.243	Graphic Size:665x915mm					

	QTY	N.W	G.W	C.B.M	Size (WxHxD)	
Packing	1	8kg	10kg	0.11	510x950x230	17L
	Visual (X-Y)		External (WxHxD)			
Product	A0 (860x1210mm)		850x1450x480mm			
15.242	Graphic Size:860x1210mm					

MIKONOS



* Custom textil printing in full color is available but not included.



SIDEWALK DETAILS



INFORMATION

DIMENSIONS

UTILITIES

Kerry 2-sided structure is made of durable lacquered galvanized steel, ensuring years of durability and functionality. For indoor and outdoor use. The antireflection protector (included) attaches quickly and easily using magnets.

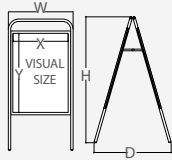

	QTY	N.W	G.W	C.B.M	Size (WxHxD)
Packing	1	11.8kg	12.7kg	0.0504	575x80x1095
		Visual (X-Y)	External (WxHxD)		
Product	462x662		544x1056x647		
10.691	<input type="radio"/>	<input checked="" type="radio"/>	<input type="radio"/>	Graphic Size: 500x700mm	

	QTY	N.W	G.W	C.B.M	Size (WxHxD)
Packing	1	16.35kg	17.9kg	0.0766	760x70x1440
		Visual (X-Y)	External (WxHxD)		
Product	662x962		744x1345x814		
10.692	<input type="radio"/>	<input checked="" type="radio"/>	<input type="radio"/>	Graphic Size: 700x1000mm	

KERRY



SIDEWALK DETAILS



INFORMATION

DIMENSIONS

UTILITIES

Cork 2-sided structure is made of durable lacquered galvanized steel. Designed for indoor and outdoor use. Also it features a top header area. The antireflection protector (included) attaches quickly and easily using magnets.

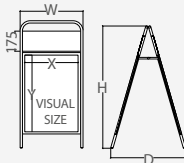

	QTY	N.W	G.W	C.B.M	Size (WxHxD)
Packing	1	11.7kg	12.7kg	0.0459	460x70x1170
		Visual (X-Y)	External (WxHxD)		
Product	462x662		544x1056x647		
504x175					
10.695	<input type="radio"/>	<input checked="" type="radio"/>	<input type="radio"/>	Graphic Size: 500x700mm Top Header Gr.Size: 504x175mm	

	QTY	N.W	G.W	C.B.M	Size (WxHxD)
Packing	1	18.65kg	20.2kg	0.0766	760x70x1440
		Visual (X-Y)	External (WxHxD)		
Product	662x962		744x1345x814		
704x175					
10.696	<input type="radio"/>	<input checked="" type="radio"/>	<input type="radio"/>	Graphic Size: 700x1000mm Top Header Gr. Size: 704x175mm	

CORK



SIDEWALK DETAILS



INFORMATION

Monaghan 2-sided board is made of durable lacquered galvanized steel available in 3 colors. Designed for indoor and outdoor use. With a top header for a graphic and antireflection protector sheet.

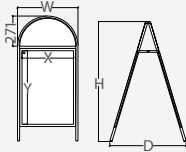

Graphic Size: 500x700mm
Top Header Gr. Size: 514x256mm

DIMENSIONS

UTILITIES

	QTY	N.W	G.W	C.B.M	Size (WxHxD)
Packing	1	11.7kg	12.7kg	0.0459	560x70x1170
		Visual (X-Y)	Visual Top (X-Y)		External (WxHxD)
Product	462x662		502x250		683x1078x683
10.699	<input type="radio"/>	<input checked="" type="radio"/>	<input type="radio"/>		

	QTY	N.W	G.W	C.B.M	Size (WxHxD)
Packing	1	20.5kg	22kg	0.0819	765x1530x70
		Visual (X-Y)	Visual Top (X-Y)		External (WxHxD)
Product	702x1002		702x361		742x1523x675
10.700	<input type="radio"/>	<input checked="" type="radio"/>	<input type="radio"/>		

Graphic Size: 700x1000mm
Top Header Gr. Size: 714x357mm

MONAGHAN



SIDEWALK DETAILS



DIMENSIONS

UTILITIES

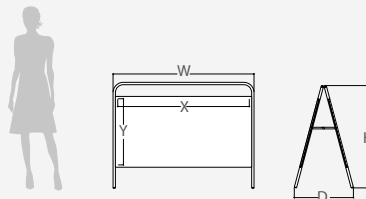

INFORMATION

Lifford 2-sided board is made of durable white lacquered galvanized steel. Designed for both indoor and outdoor. With antireflection protector included which attaches easily to the front using magnets. Ideal to use together with other(s) Lifford for creating a large billboard (see example at right).

	QTY	N.W	G.W	C.B.M	Size (WxHxD)
Packing	1	15.7kg	17kg	0.0751	935x65x1235
		Visual (X-Y)	External (WxHxD)		
Product	1120x564		1200x872x505		
10.701	<input type="radio"/>	<input type="radio"/>	<input type="radio"/>		

Graphic Size: 1158x600mm

LIFFORD



*10.701 Lifford Board at this page is sold by units, the image represented is just one example of its joint use.

SIDEWALK DETAILS

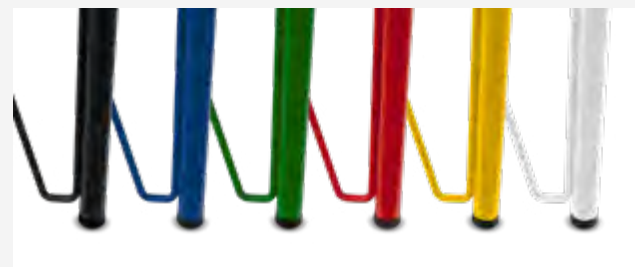

DIMENSIONS

*mm

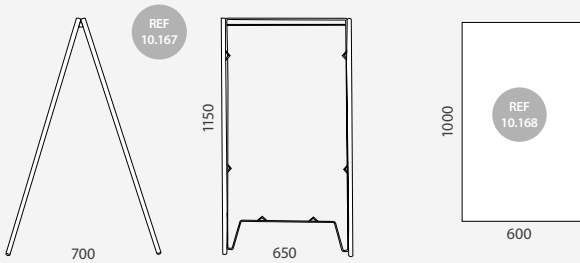

INFORMATION

UTILITIES

The Steel A-board is made of durable Epoxi painted Steel. Featuring 6 colors available and the possibility of being used with a white board panel which is sold separately (10.168). Ideal to advertise home sales, open houses, restaurant specials, store sales or promotional services. To change out signs, just slide the poster through the steel holders.

	QTY	N.W	G.W	C.B.M	Size (WxHxD)
Packing	1	6kg	6.7kg	0.0523	1200x65x670
		Visual (X-Y)	External (WxHxD)		
Product		600x1000	650x1150x700		

10.167      

	QTY	N.W	G.W	C.B.M	Size (WxHxD)
Packing	1	1kg	1kg	0.0523	1200x65x670
10.168		Total Size: 600x1000mm			

STEEL A-BOARD

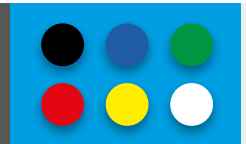

SIDEWALK DETAILS



INFORMATION

* W: Width H: Height D: Depth * mm

The double-sided Dover A-Board features 3 different models, the first one comes with handle for an easy transportation, second one features all along customizable front for a great visual impact and the third model features a Blackboard on both sides.

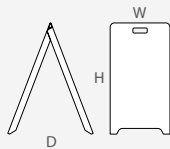

	QTY	N.W	G.W	C.B.M	Size (WxHxD)
Packing	1	1.4kg	2kg	0.0258	525x55x895
	Visual (X-Y)	13.129	Visual (X-Y)	13.130 13.131	External (WxHxD)
Product	480x765		480x815		510x840x600
13.129	Graphic Size: 480x765mm				
13.130	Graphic Size: 480x815mm				
13.131	Blackboard: 480x815mm				

DOVER



STAND DETAILS





INFORMATION

DIMENSIONS *mm

UTILITIES

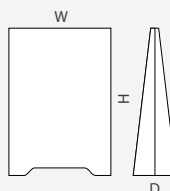
The Neiva stand A-Board has a white finish so it is ideal for customizing with your own offers or graphics. Inexpensive, durable and lightweight, making it easy to relocate as often as needed and it's assembled in seconds. Perfect as Eye-catching advertisement for indoor product promotions.



	QTY	N.W	G.W	C.B.M	Size (WxHxD)
Packing	2	1.74kg	2.74kg	0.0569	1055x980x55mm
	Visual (X-Y)		External (WxHxD)		
Product	540x780		540x770x310		
13.748	Graphic Size: 1158x600mm				x2 

NEIVA



SIDEWALK DETAILS



DIMENSIONS

*mm UTILITIES

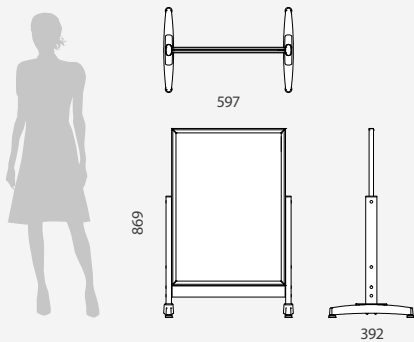

INFORMATION

Aluminium Board Display is lacquered in gray RAL 9006 and features an easy to load and upload system. With adjustable stability sturdy feet and an easy glide for the 700mm height graphic poster (9mm max.thickness) into the metal grooves of the structure and display it back-to-back. Ideal for promoting at trade shows, outside your office or showroom.

ALUMINIUM BOARD FRAME BASE



	QTY	N.W	G.W	C.B.M	SIZE
Packing	1	3.29kg	4.48kg	0.0436	880x660x75mm
13.598	Graphic Size: 500x700mm				

DISPLAY DETAILS



INFORMATION DIMENSIONS UTILITIES *mm

It is built with long-lasting plastic to resist rust and other weather related damage. It is able to fit 550x748mm posters (5mm max. thick). Fast and simple change of graphic thanks its top insert slots. Lightweight and it folds down quickly for carrying and for an easy storage.

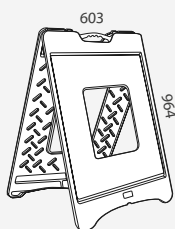

	QTY	N.W	G.W	C.B.M	SIZE
Packing	1	7kg	8kg	0.05	630x80x1010mm
10.679	Graphic Size: 550x748mm				

DELTA



DISPLAY DETAILS



INFORMATION DIMENSIONS UTILITIES *mm

The Ocean outdoor unit is designed for indoor and outdoor use with a plastic 10l water refillable base and an oscillating 620x1000mm board, the advertising options are numerous for your business outdoor sign. Each board is double-sided for twice the promotion. First, use the foot to tilt the board slightly toward to you. Then, move the Display behind you using its wheels.

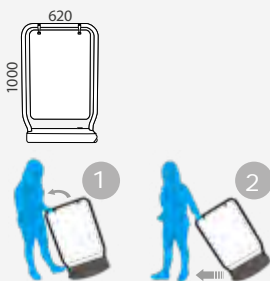

	QTY	N.W	G.W	C.B.M	SIZE
Packing	1	5.4kg	7.0kg	0.17	1100x140x1100mm
10.305	Graphic Size: 500x750mm				

OCEAN





Blackboards & Showcases

02

A full range of blackboards and easels which provide an integral solution for the signage exhibition at selling point areas.

- 80 EASEL BLACKBOARDS
- 81 STANDING BLACKBOARDS
- 88 HANGING BLACKBOARDS
- 91 TABLETOP BLACKBOARDS
- 93 TABLETOP EASELS
- 95 EASEL STANDS
- 97 BOARDS
- 99 ACCESSORIES
- 100 SHOWCASES

CO < ESPRESSO



BLACKBOARD DETAILS

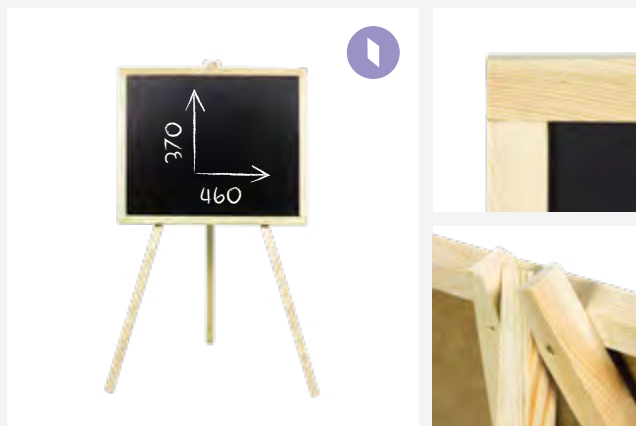

INFORMATION

This wooden one-sided easel is made of light wood, its neutral color allows the chalkboard to blend in virtually to any indoor locations. Featuring a folding rear leg for an easy storage and transportation. These Blackboards are ideal for being used at retail shops, bars, restaurants or for school classrooms.

DIMENSIONS * mm

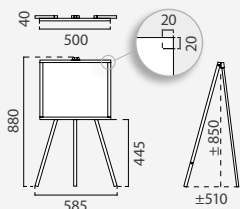

	QTY	N.W	G.W	C.B.M	SIZE
Packing	1	4.5kg	5.5kg	0.0324	600x60x900mm
14.113	Fold: 585x880x40mm		Frame: 20mm		

ONE-SIDED EASEL



BLACKBOARD DETAILS

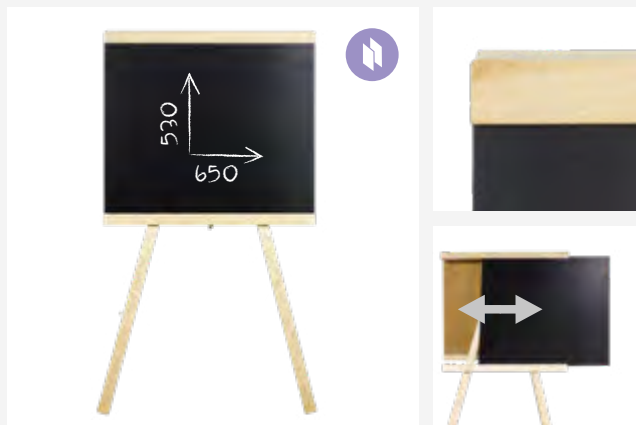

INFORMATION

2-sided easel made of light wood with interchangeable and removable boards for a more comfortable graphic change. You can insert 2.5mm advertising on both sides, which helps to draw more potential customer coming from both directions into your business. Ideal for displaying at retail shops, food trucks or restaurants.

DIMENSIONS * mm

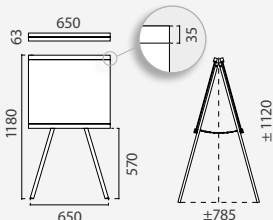

	QTY	N.W	G.W	C.B.M	SIZE
Packing	1	4kg	4.5kg	0.064	670x80x1200mm
14.114	Fold: 650x1180x63mm		Frame: 35mm		

DOUBLE-SIDED EASEL WITH REMOVABLE BOARDS



BLACKBOARD DETAILS

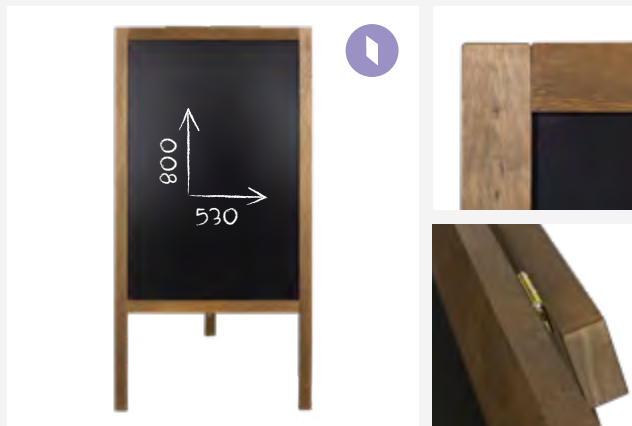

INFORMATION

Single sided A-Board made of wood with High Density Fiberboard blackboard and natural wooden color which allows it to blend in virtually to any indoor locations. Easy storage and transportation thanks to its folding rear leg. These Blackboards are ideal for being used at coffe shops, retail shops, at restaurants or for the schools.

DIMENSIONS

* mm

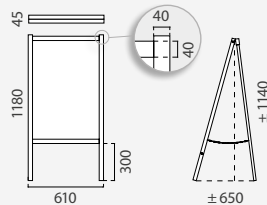

	QTY	N.W	G.W	C.B.M	SIZE
Packing	1	6kg	6.5kg	0.04	620x55x1200mm
14.112	Fold: 610x1180x45mm		Frame: 40mm		

ONE-SIDED 61x118cm BLACKBOARD



BLACKBOARD DETAILS

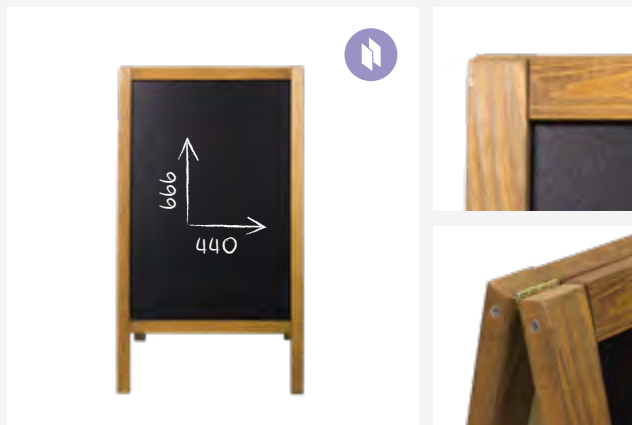

INFORMATION

Stained and lacquered double-sided A-Board made of wood with High Density Fiberboard. The double-sided signs help to draw more potential customer coming from both directions into your business. Ideal for displaying at supermarkets, restaurants or for the schools. Perfect to advertise multiple promotions at once.

DIMENSIONS

* mm

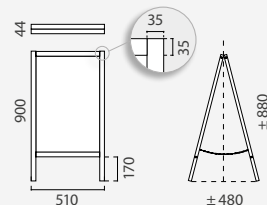

	QTY	N.W	G.W	C.B.M	SIZE
Packing	1	3.1kg	4kg	0.03	520x55x920mm
14.103	Fold: 510x900x44mm		Frame: 35mm		

DOUBLE-SIDED 51x90cm BLACKBOARD



BLACKBOARD DETAILS

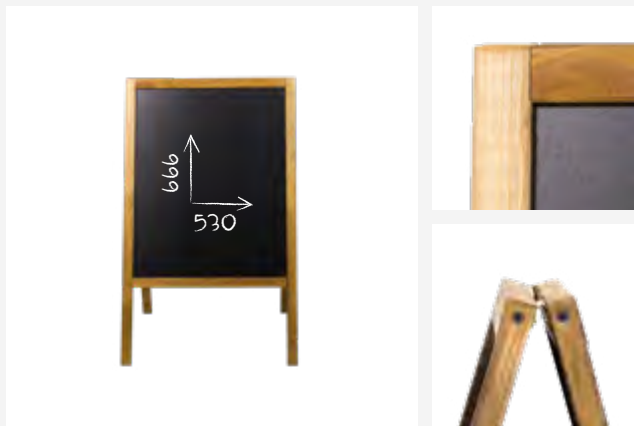

INFORMATION

Stained and lacquered wooden double-sided "A" Shaped Board. Made of wood with High Density Fiberboard. The double-sided signs help to draw more potential customer coming from both directions into your business. Ideal for displaying at retail shops, bars, coffee shops or for the schools.

DIMENSIONS

* mm

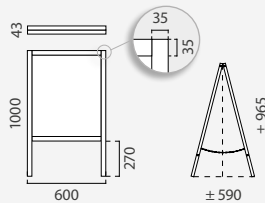

QTY	N.W	G.W	C.B.M	SIZE	
Packing	1	4.5kg	5.5kg	0.034	610x55x1020mm
14.104	Fold: 600x1000x43mm		Frame: 35mm		

DOUBLE-SIDED 60x100cm BLACKBOARD



BLACKBOARD DETAILS



INFORMATION

Stained and lacquered wooden double-sided "A" Shaped Board. Made of wood with High Density Fiberboard. The double-sided signs help to draw more potential customer coming from both directions into your business. Ideal for displaying at bar terraces, restaurants, coffee shops or for schools.

DIMENSIONS

* mm

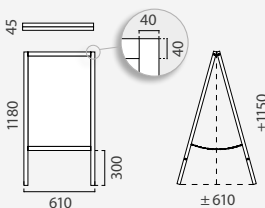

QTY	N.W	G.W	C.B.M	SIZE	
Packing	1	6kg	7kg	0.04	615x55x1200mm
14.105	Fold: 610x1180x45mm		Frame: 40mm		

DOUBLE-SIDED 61x118cm BLACKBOARD



BLACKBOARD DETAILS

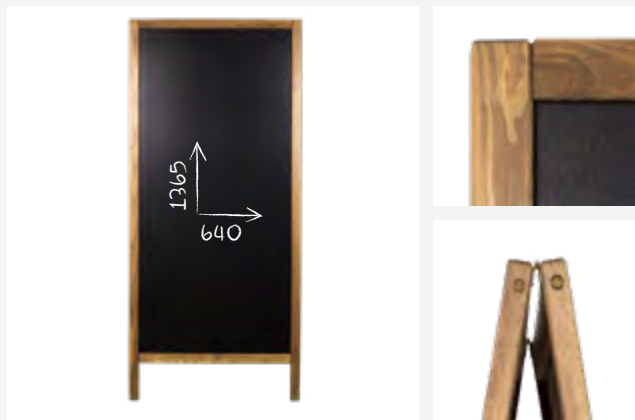

INFORMATION

2-sided A-Board with High Density Fiberboard blackboard and natural wooden color which allows it to blend in virtually to any indoor locations. Featuring the larger blackboard available in this catalogue. Foldable for an easy storage. Ideal for being used at retail shops, bars, restaurants or for schools.

DIMENSIONS

* mm

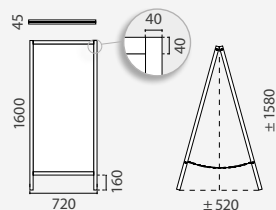

QTY N.W G.W C.B.M SIZE

Packing 1 8kg 10kg 0.064 725x50x1625mm

14.107 Fold: 720x1600x45mm Frame: 40mm

DOUBLE-SIDED 72x160cm XL BLACKBOARD



BLACKBOARD DETAILS



INFORMATION

Stained and lacquered foldable wooden 2-sided A-Board with extended top for advertising space. Made High Density Fiberboard wood. The top part of the frame can be engraved on request, please contact us. The 2-sided signs help to draw more potential customer coming from both directions to your business.

DIMENSIONS

* mm

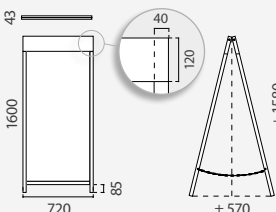

QTY N.W G.W C.B.M SIZE

Packing 1 6kg 7kg 0.071 740x60x1620mm

14.120 Fold: 720x1600x43mm Top: 720x120mm

DOUBLE-SIDED 72x160cm LOGO BLACKBOARD



* the pyrography at the top of ref. 14.120 is just a suggestion and it is not included.

BLACKBOARD DETAILS

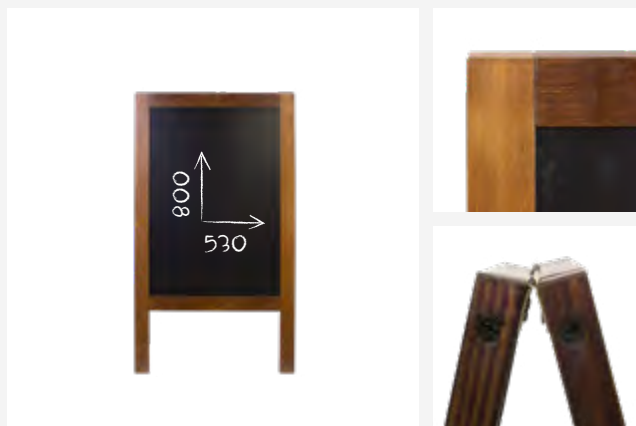

INFORMATION

This stained and lacquered double-sided "A" Shaped Board is made of wood with High Density Fiberboard. Foldable. The 2-sided signs help to draw more potential customer coming from both directions into your business. Ideal for displaying at retail shops, bars, coffee shops or for the schools.

DIMENSIONS * mm

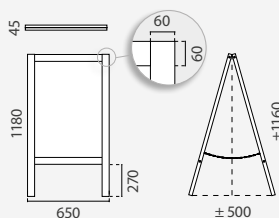

	QTY	N.W	G.W	C.B.M	SIZE
Packing	1	6kg	7kg	0.039	660x55x1200mm
14.110	Fold: 650x1180x45mm		Frame: 60mm		

DOUBLE-SIDED 65x118cm BLACKBOARD



BLACKBOARD DETAILS



INFORMATION

Stained and lacquered wooden stylish Blackboard. Made of wood with High Density Fiberboard. Foldable. The double-sided signs help to draw more potential customer coming from both directions into your business. Ideal for displaying in places where a distinctive touch is sought, such as restaurants or academies.

DIMENSIONS * mm

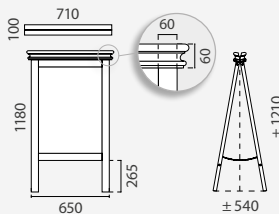

	QTY	N.W	G.W	C.B.M	SIZE
Packing	1	6kg	7kg	0.1	670x120x1250mm
14.111	Fold: 710x1180x100mm		Frame: 60mm		

DOUBLE-SIDED 65x118cm SPECIAL TOP BLACKBOARD



BLACKBOARD DETAILS

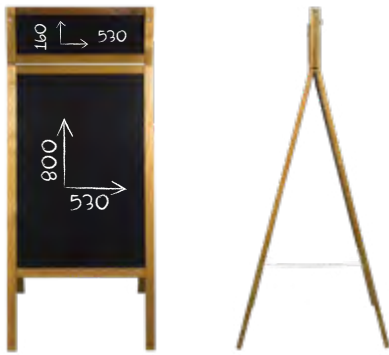

DIMENSIONS

* mm

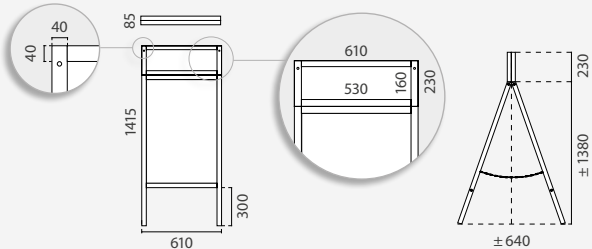

INFORMATION

This double-sided A-Board is made of wood with High Density Fiberboard blackboard. Its natural wooden color allows the chalkboard to blend in virtually to any indoor locations. Featuring a space header for advert. Foldable for easy storage and mobility. These Blackboards are ideal for being used at retail shops, coffee shops, restaurants or for schools. To write on this a-frame blackboard, users are recommended to use regular stick chalks (not included).

DOUBLE-SIDED 61x141cm TOP HEADER BLACKBOARD



	QTY	N.W	G.W	C.B.M	SIZE
Packing	1	7kg	8.5kg	0.12	630x160x1200mm
14.118	Fold: 610x1180x85mm		Frame: 40mm		

STANDING BLACKBOARDS Blackboards

BLACKBOARD DETAILS

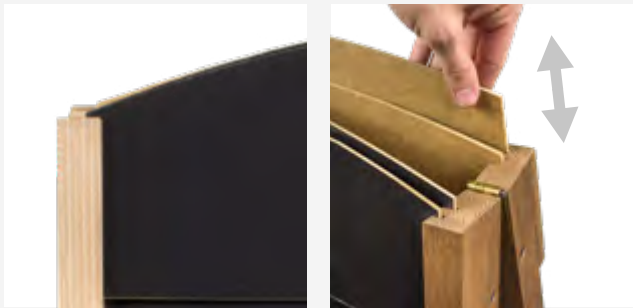

DIMENSIONS

* mm

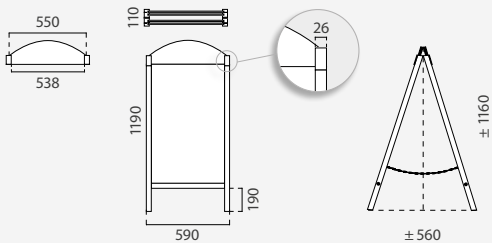

INFORMATION

This 2-sided A-Board has interchangeable plates for adverts (3mm thickness) and it is made of stained and lacquered wood with High Density Fiberboard. The double-sided signs help to draw more potential customer coming from both directions into your business. Ideal for displaying at retail stores, restaurants or for schools. Foldable for easy storage and mobility. To write on this a-frame black board, users are recommended to use regular stick chalks (not included).

	QTY	N.W	G.W	C.B.M	SIZE
Packing	1	6kg	7kg	0.0991	610x130x1250mm
14.119	Fold: 590x1190x110mm		Top: 165x530mm		

DOUBLE-SIDED 59x119cm INTERCHANGEABLE TOP BOARD



BLACKBOARD DETAILS

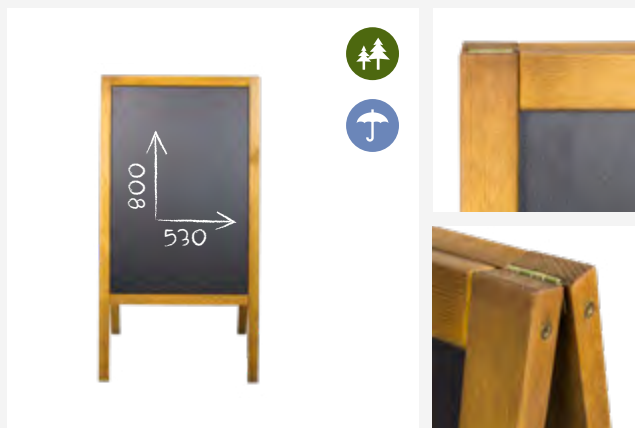

INFORMATION

Stained and lacquered waterproof double-sided "A" Shaped Board. It features an ABS blackboard. It is protected against harmful weather conditions. The 2-sided signs help to draw more potential customer coming from both directions into your business. Ideal for displaying at retail stores, coffee shops or for the schools. Foldable for an easy storage.

DIMENSIONS

* mm

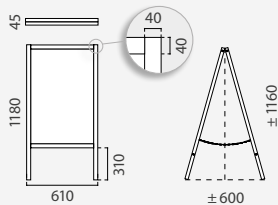

	QTY	N.W	G.W	C.B.M	SIZE
Packing	1	6kg	7kg	0.037	620x50x1200mm
14.106	Fold: 610x1180x45mm		Frame: 40mm		

DOUBLE-SIDED 61x118cm WATERPROOF BLACKBOARD



BLACKBOARD DETAILS

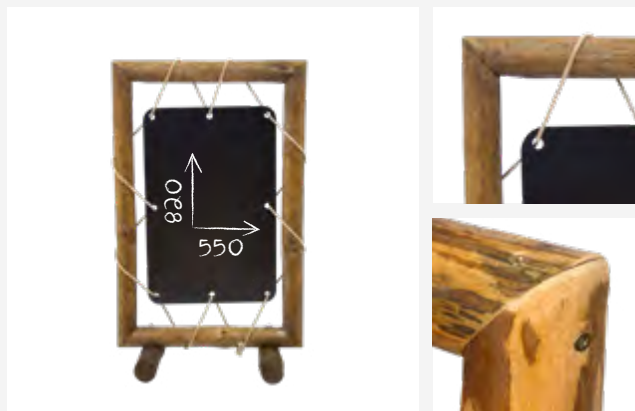

INFORMATION

This stained and lacquered wooden double-sided Board is made of natural logs. The 2-sided signs help to draw more potential customer coming from both directions into your business. Ideal for displaying at retail shops, bars, tourist areas or restaurants. Rotating logs for an easy storage and to facilitate mobility.

DIMENSIONS

* mm

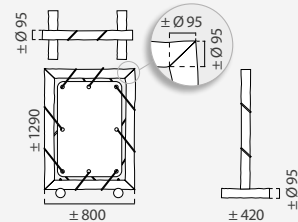

	QTY	N.W	G.W	C.B.M	SIZE
Packing	1	13kg	14.5kg	0,1428	850x120x1400mm
14.116	Fold: 800x1290x95mm		± Ø95mm		

DOUBLE-SIDED 80x129cm WOOD LOGS BLACKBOARD





BLACKBOARDS DETAILS

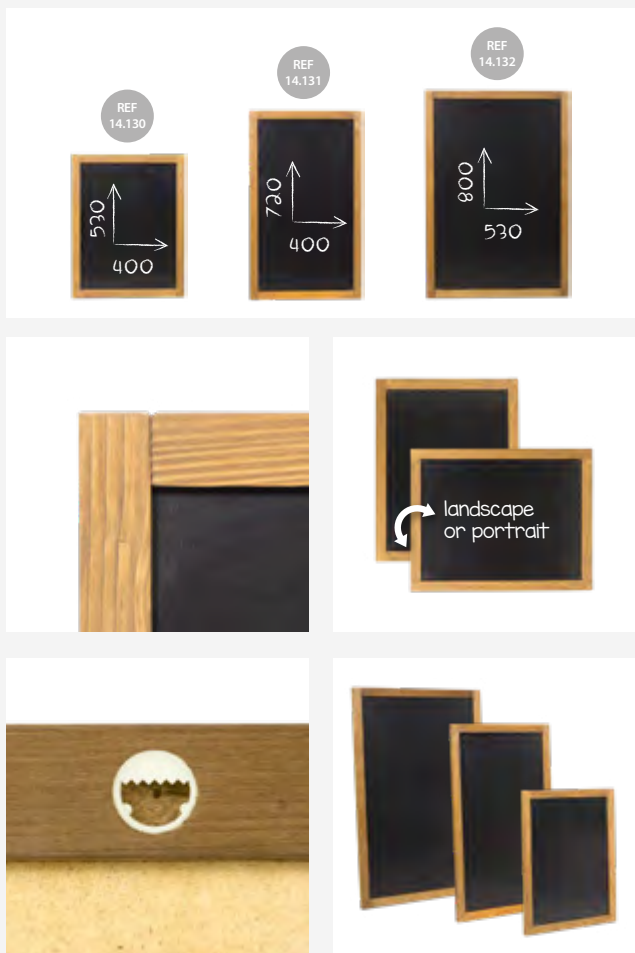

DIMENSIONS

* mm

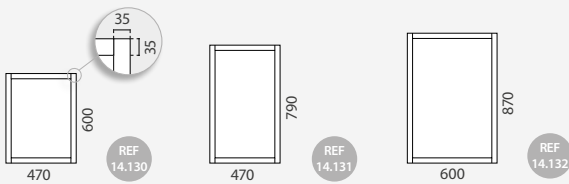

INFORMATION

This hanging frame is made of stained wood with HDF board. All of them have an appropriate hanger included. With 3 sizes available. Perfect for displaying last company's offers. Ideal for being used at retail shops, bars, restaurants, etc...

	QTY	N.W	G.W	C.B.M	SIZE
Packing	1	1.2kg	2kg	0.009	490x30x620mm
14.130	Outer Size: 470x600x20mm		Frame: 35mm		
	QTY	N.W	G.W	C.B.M	SIZE
Packing	1	1.5kg	2.5kg	0.011	490x30x810mm
14.131	Outer Size: 470x790x20mm		Frame: 35mm		
	QTY	N.W	G.W	C.B.M	SIZE
Packing	1	2kg	3kg	0.016	620x30x890mm
14.132	Outer Size: 600x870x20mm		Frame: 35mm		

HANGING 3.5cm FRAME CLASIC BLACKBOARD



HANGING BLACKBOARDS Top Logo Frame

BLACKBOARDS DETAILS



DIMENSIONS

* mm

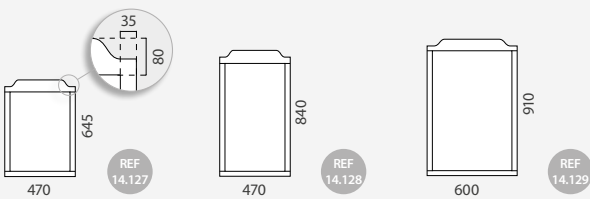

INFORMATION

This hanging frame features an extended top space. All of them have an appropriate hanger system. With 3 sizes available. Perfect for displaying last company's offers. Ideal for being used at retail shops, bars, restaurants, etc..

	QTY	N.W	G.W	C.B.M	SIZE
Packing	1	1.2kg	2kg	0.009	490x30x660mm

14.127 Outer Size: 470x645x20mm

	QTY	N.W	G.W	C.B.M	SIZE
Packing	1	1.5kg	2.5kg	0.012	490x30x860mm

14.128 Outer Size: 470x840x20mm

	QTY	N.W	G.W	C.B.M	SIZE
Packing	1	2kg	3kg	0.017	620x30x930mm

14.129 Outer Size: 600x910x20mm

HANGING 3.5cm FRAME TOP LOGO BLACKBOARD



HANGING BLACKBOARDS Lacquered Stylish Frame

BLACKBOARDS DETAILS



DIMENSIONS

* mm

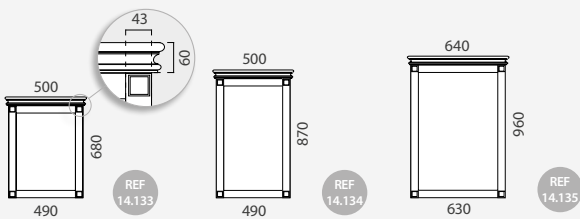

INFORMATION

This hanging frame is made of lacquered wood with a stylish decorative cornice embellishment top. All hanging boards have an appropriate hanger included. 3 sizes available. Ideal for being used at retail shops, coffee shops or restaurants.

	QTY	N.W	G.W	C.B.M	SIZE
Packing	1	1.5kg	2.5kg	0.025	520x70x710mm
14.133	Outer Size: 500x680x47mm				
	QTY	N.W	G.W	C.B.M	SIZE
Packing	1	2kg	3kg	0.032	520x70x910mm
14.134	Outer Size: 500x870x47mm				
	QTY	N.W	G.W	C.B.M	SIZE
Packing	1	2.5kg	3.5kg	0.044	650x70x980mm
14.135	Outer Size: 640x960x47mm				

HANGING 4.3cm LACQUERED FRAME STYLISH BLACKBOARD



TABLETOP BLACKBOARDS Slanted | Base

BLACKBOARDS DETAILS



INFORMATION

DIMENSIONS

* mm

Slate displays are made of stained wood and HDF board, and come in A4 or A5 format, so you can choose the appropriate size for your showing.

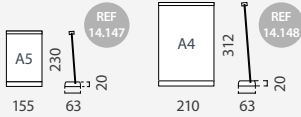

	QTY	N.W	G.W	C.B.M	SIZE
--	-----	-----	-----	-------	------

Packing	1	0.4kg	1kg	0.0039	175x90x250mm
---------	---	-------	-----	--------	--------------

14.147 Outer Size: 155x230x63mm Base: 155x63x20mm

	QTY	N.W	G.W	C.B.M	SIZE
--	-----	-----	-----	-------	------

Packing	1	0.5kg	1kg	0.007	230x90x340mm
---------	---	-------	-----	-------	--------------

14.148 Outer Size: 210x312x63mm Base: 210x63x20mm

ONE SIDED TABLETOP SLANTED BLACKBOARD



BLACKBOARDS DETAILS



INFORMATION

DIMENSIONS

* mm

Blackboards are made of stained wood and HDF board. Ideal to announce upcoming events, shows, meetings or drinks offers at bars or restaurants.

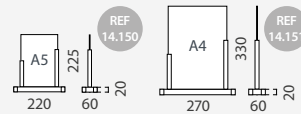

	QTY	N.W	G.W	C.B.M	SIZE
--	-----	-----	-----	-------	------

Packing	1	0.32kg	1kg	0.0044	230x80x240mm
---------	---	--------	-----	--------	--------------

14.150 Outer Size: 220x225x60mm Base: 220x60x20mm

	QTY	N.W	G.W	C.B.M	SIZE
--	-----	-----	-----	-------	------

Packing	1	0.6kg	1kg	0.0081	350x80x290mm
---------	---	-------	-----	--------	--------------

14.151 Outer Size: 270x330x60mm Base: 270x60x20mm

DOUBLE SIDED TABLETOP BASE BLACKBOARD



BLACKBOARDS DETAILS



INFORMATION

DIMENSIONS

* mm

These 2-sided HDF A-boards come in A4 or A5 sizes. Ideal to announce upcoming events, promotional shows, meetings or offers at your bar, club or restaurant.

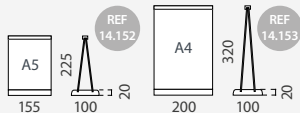

	QTY	N.W	G.W	C.B.M	SIZE
--	-----	-----	-----	-------	------

Packing	1	0.25kg	1kg	0.0052	175x120x250mm
---------	---	--------	-----	--------	---------------

14.152 Outer Size: 155x225x100mm Base: 155x100x20mm

	QTY	N.W	G.W	C.B.M	SIZE
--	-----	-----	-----	-------	------

Packing	1	0.4kg	1kg	0.0089	220x120x340mm
---------	---	-------	-----	--------	---------------

14.153 Outer Size: 200x320x100mm Base: 200x100x20mm

DOUBLE SIDED TABLETOP TENT BLACKBOARD



BLACKBOARDS DETAILS



INFORMATION

DIMENSIONS

* mm

The double sided HDF A-boards feature a stylish framed design. Ideal to announce upcoming events, shows, meetings or drinks offers at your club or restaurant.

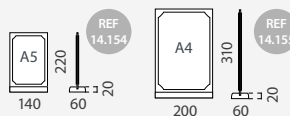

	QTY	N.W	G.W	C.B.M	SIZE
--	-----	-----	-----	-------	------

Packing	1	0.3kg	1kg	0.003	160x80x240mm
---------	---	-------	-----	-------	--------------

14.154 Outer Size: 140x220x60mm Base: 140x60x20mm

	QTY	N.W	G.W	C.B.M	SIZE
--	-----	-----	-----	-------	------

Packing	1	0.5kg	1kg	0.0058	220x80x330mm
---------	---	-------	-----	--------	--------------

14.155 Outer Size: 200x310x60mm Base: 200x60x20mm

DOUBLE SIDED TABLETOP FRAMING BLACKBOARD



BLACKBOARD DETAILS

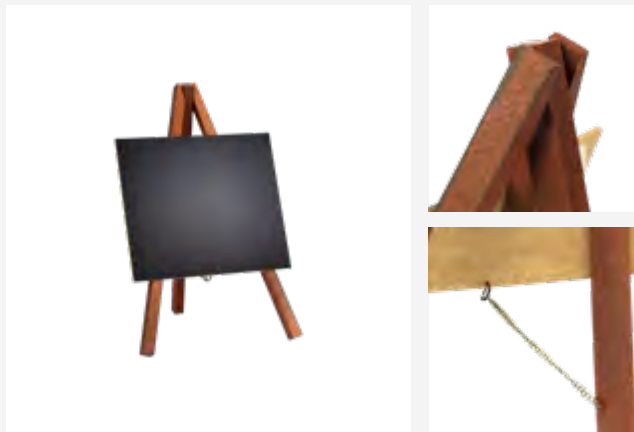

INFORMATION

DIMENSIONS

* mm

This tabletop blackboard is made of stained wood. It includes an adjustable angle back leg and a chain stopper. Perfect for displaying at the academies entrances, on the information desks, at the waiting rooms or at the offices...

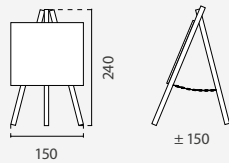

	QTY	N.W	G.W	C.B.M	SIZE
Packing	1	0.4kg	1kg	0.017	170x40x260mm
14.149		Fold: 150x240x20mm		Header: 150x130mm	

ONE SIDED TABLETOP EASEL BLACKBOARD



TABLETOP EASELS Tabletop Wooden Easels

EASEL DETAILS



INFORMATION

DIMENSIONS

* mm

The mini wood Easels, rely on their triangular silhouette to provide a solid base for your painting and they fold flat for easy storage. They are ideal for displaying art, photography at meetings, galleries, etc... Perfect to display with a touch of distinction and in small spaces.

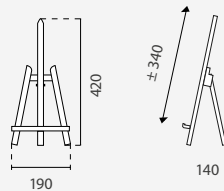

	QTY	N.W	G.W	C.B.M	SIZE
Packing	1	0.5kg	1kg	0.0073	210x80x440mm
14.141	Folded Size: 190x60x420mm		Strip: 20mm		

TABLETOP WOODEN EASEL 42x19-34cm



EASEL DETAILS



INFORMATION

DIMENSIONS

* mm

The mini wood Easels, rely on their triangular silhouette to provide a solid base for your painting and they fold flat for easy storage. It features an adjustable angle back leg. They are ideal for displaying art, photography at meetings, galleries, etc... Perfect to display with a touch of distinction and in small spaces.

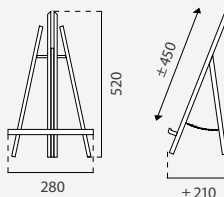

	QTY	N.W	G.W	C.B.M	SIZE
Packing	1	0.5kg	1kg	0.011	300x70x540mm
14.142	Folded Size: 280x50x520mm		Strip: 20mm		

TABLETOP WOODEN EASEL 52x28-45cm



TABLETOP EASELS Tabletop Wooden Easels

EASEL DETAILS



INFORMATION

DIMENSIONS

* mm

This Easel provides a solid base for your painting and it fold flat for easy storage. It features a canvas height adjustment, so you can accommodate canvas up to 540mm in height. Ideal for displaying art, photography at meetings, galleries, etc... Perfect to display with a touch of distinction and in small spaces.

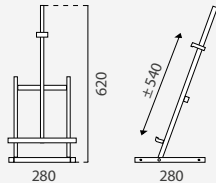

	QTY	N.W	G.W	C.B.M	SIZE
Packing	1	0.5kg	1kg	0.019	300x100x640mm
14.143	Folded Size: 280x90x700mm		Strip: 20mm		

TABLETOP WOODEN EASEL 62x28-54cm



EASEL DETAILS



INFORMATION

DIMENSIONS

* mm

A-Wooden Easel features a triangular silhouette to provide a solid base for your graphic or your paintings. The rear leg allows for placement in corners and tight spaces and can be flattened for easy storage. Ideal as elegantly promotional display, also many business and home owners use it to showcase fine art or photography.

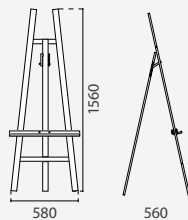

	QTY	N.W	G.W	C.B.M	SIZE
Packing	1	3kg	4kg	0.428	600x420x1700mm
14.140	Folded: 580x110x1560mm		Strip: 40mm		

WOODEN EASEL 156x60-122cm



EASEL DETAILS



INFORMATION

This classic Wooden Easel features a canvas adjustment up to 1330mm in height. The rear leg allows for placement in corners and tight spaces and also, it can be flattened for easy storage. Ideal as elegantly promotional display, also many business and home owners use it to showcase fine art or photography.

DIMENSIONS * mm

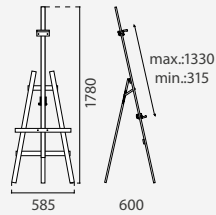

	QTY	N.W	G.W	C.B.M	SIZE
Packing	1	3kg	4kg	0.504	600x40x2000mm
14.139	Folded: 585x110x1780mm		Strip: 40mm		

WOODEN EASEL

178x60-133cm



EASEL DETAILS

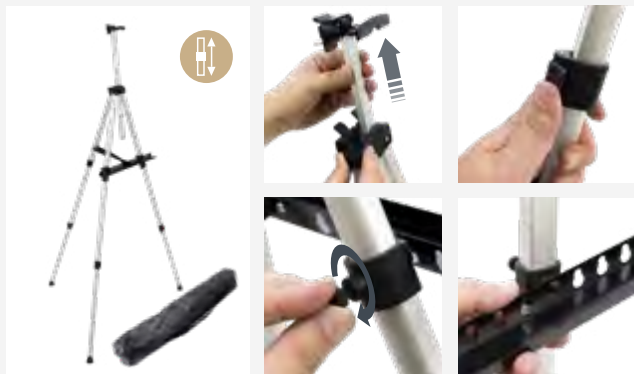

INFORMATION

Solana is made with an aluminum alloy that is strong and stable, featuring adjustable height, so its telescopic legs can be shortened for table top use or lengthened for a floor standing display. This telescoping aluminum easel is a versatile method to use for any type of showcase. Whether you're travelling for tradeshows or art exhibits, use this silver telescoping easel for a durable, yet convenient tool to display your work.

DIMENSIONS * mm

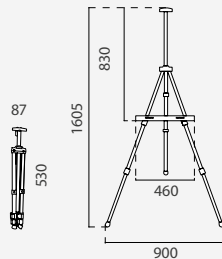

	QTY	N.W	G.W	C.B.M	Size
Packing	1	0.65kg	0.75kg	0.0035	80x560x80
10.816	Folded: 87x530x65mm Max. Outer Size: 780x1605x900mm				

SOLANA EASEL



BOARD DETAILS

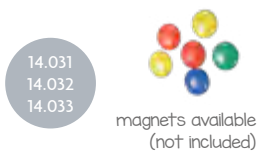

INFORMATION

DIMENSIONS * W: Width H: Height

This whiteboard features a magnetic surface easy to clean, which is suitable for writing with erasable markers. It is a versatile presentation tool that you can use in various settings to supplement an informative presentation. Ideal for classrooms or conference offices.

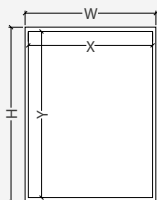

	EXTERNAL (WxH)	VISUAL (X-Y)	A4 QTY
10.329	502x672mm	487x657mm	4 x A4
14.094	502x992mm	487x977mm	6 x A4
14.095	732x992mm	717x977mm	9 x A4
10.332	962x992mm	947x977mm	12 x A4

RENNES BOARD



* Markers at this page are not included

BOARD DETAILS



INFORMATION

DIMENSIONS * W: Width H: Height

This whiteboard is equipped with a perforated magnetic surface that covers a cork board, so you can hold paper notes with pins or magnets. It is a versatile presentation tool that you can use in various settings to supplement an informative presentation. It is ideal for classrooms or for conference offices.

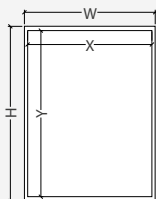

	EXTERNAL (WxH)	VISUAL (X-Y)	A4 QTY
10.333	502x672mm	487x657mm	4 x A4
10.334	502x992mm	487x977mm	6 x A4
14.096	732x992mm	717x977mm	9 x A4
14.097	962x992mm	947x977mm	12 x A4

SALLES BOARD

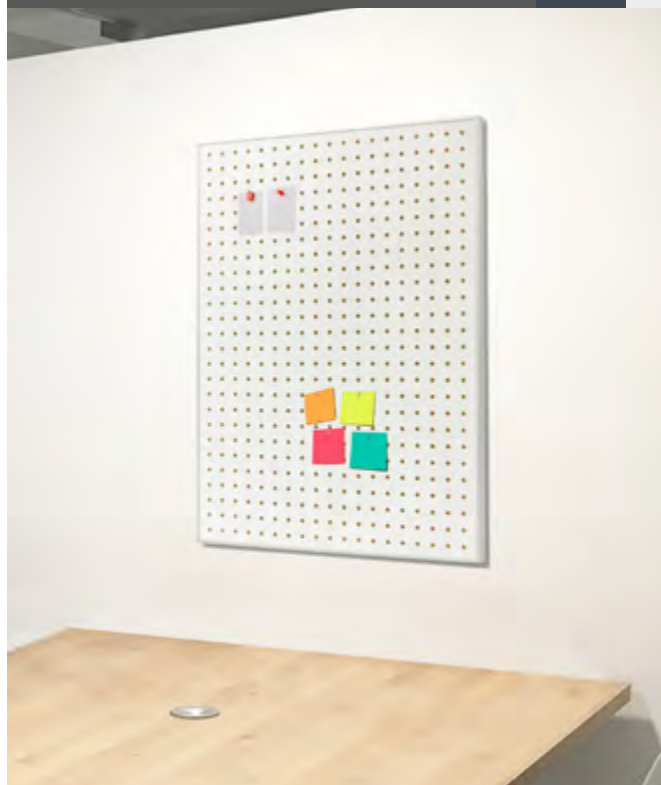

* Magnets and pins at this page are available but not included

BOARD DETAILS

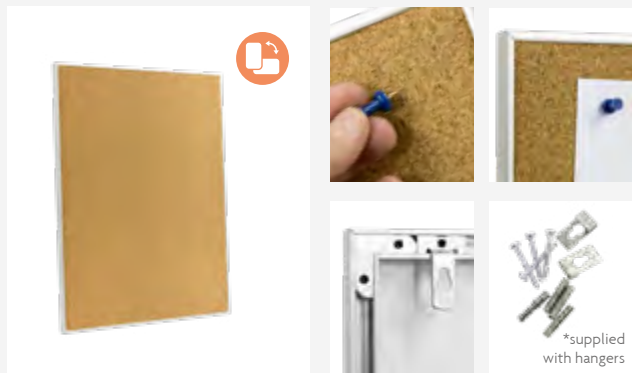

INFORMATION

* W: Width H: Height

Dax cork board is made of aluminum frame with metallic hangers. It features a self healing, finely ground cork surface that will stand up for years of use. Hangers and screws are included. Ideal for being used at hospitals, schools, for government agencies, conference offices or for common rooms.

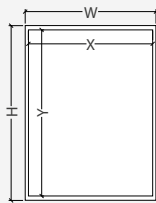

	EXTERNAL (WxH)	VISUAL (X-Y)	A4 QTY
10.320	502x672mm	487x657mm	4 x A4
10.321	502x992mm	487x977mm	6 x A4
10.325	732x992mm	717x977mm	9 x A4
10.328	962x992mm	947x977mm	12 x A4

DAX FRAME BOARD



BOARD DETAILS

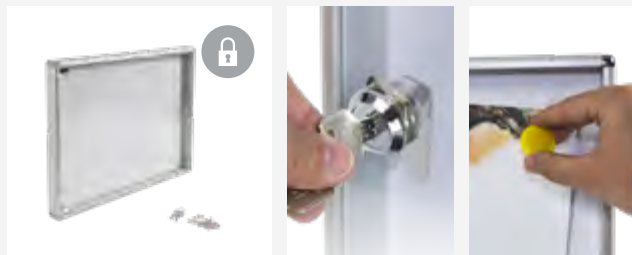

INFORMATION

DIMENSIONS

* mm

Bulletin Board Box is made of anodized aluminium and designed with a single acrylic lockable door, that provides controlled access to the posting surface A4 or 2xA4 format available. It is ideal for signs, announcements, messages, photos or memorabilia. Ideal at community common areas, schools, universities or supermarkets.

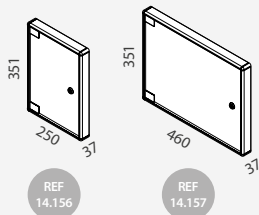

	QTY	N.W	G.W	C.B.M	SIZE
Packing	1	1.453kg	1.65kg	0.0052	400x280x46 mm
14.156	1xA4	External Size: 250x351x37mm			

	QTY	N.W	G.W	C.B.M	SIZE
Packing	1	2.43kg	2.68kg	0.0095	506x375x50 mm
14.157	2xA4	External Size: 460x351x37mm			

BULLETIN BOARD BOX
WATERLOO



* Magnets and pins at this page are available but not included.

PINS DETAILS



INFORMATION

Metallic pins with plastic colored headers that are suitable for cork boards.

14.034	100 units
--------	-----------

PINS



MAGNETS DETAILS



INFORMATION

These colored magnets are suitable for boards with metallic background.

	DIAMETER	
14.031	Ø 20mm	x12 
14.032	Ø 30mm	x6 
14.033	Ø 40mm	x4 

MAGNETS



ERASER DETAILS



INFORMATION

Plastic eraser that is suitable for being used with erasable markers.

14.030

ERASER



BOARD DETAILS

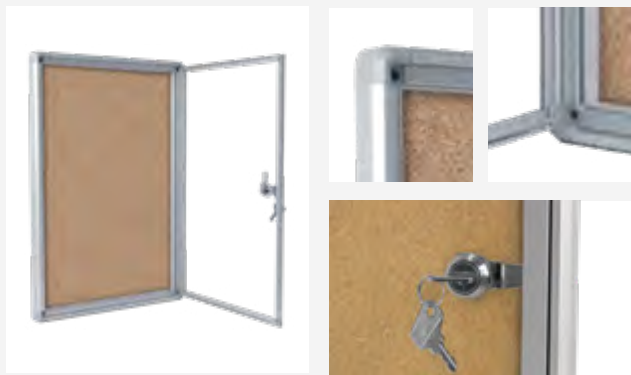

INFORMATION

* W: Width H: Height

This showcase with aluminium frame and acrylic lockable door includes a background made of cork. Featuring rounded corners and a front locker. These bulletin boards exhibit your important information in hallways, classrooms, vestibules, reception rooms or more! The single lockable door ensures that documents, graphics or pictures stay clean and undisturbed.

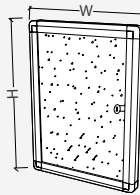

SIZES

14.090	250x400mm		
14.043	350x500mm		
14.044	500x700mm		
14.091	600x600mm		

BAYERN



BOARD DETAILS

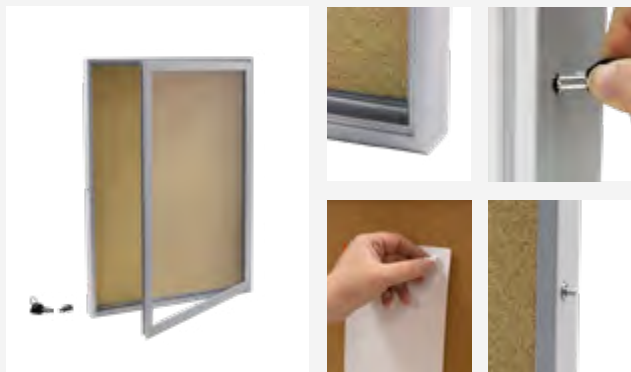

INFORMATION

PROFILE DETAIL * mm

This showcase with aluminium frame and acrylic lockable door includes a background made of cork. Featuring a side locker. This bulletin board exhibits your important information in hallways, classrooms, vestibules, reception rooms or more! The single lockable door ensures that documents, graphics or pictures stay clean and undisturbed.

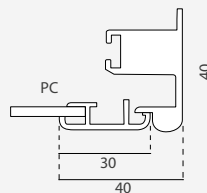

SIZES

14.084	500x700mm		
14.085	600x800mm		
14.086	700x1000mm		

ROSTOCK



* Pins at this page are available but not included.

BOARD DETAILS

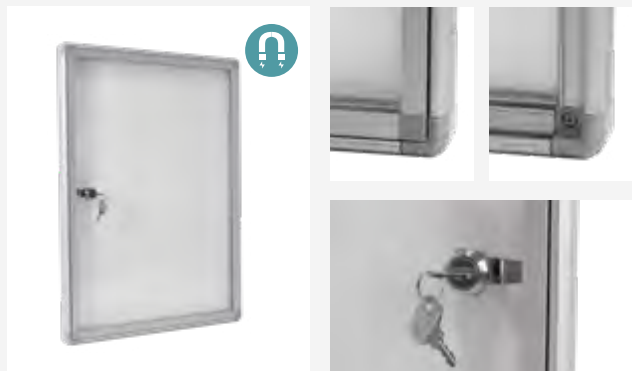

INFORMATION

* W: Width H: Height

This showcase with aluminium frame and acrylic lockable door includes a metallic background. Featuring rounded corners and a front locker. This enclosed bulletin board provides a perfect display space for postings such as announcements or creative advertisements. The single lockable door ensures that documents, graphics or pictures stay clean and undisturbed.

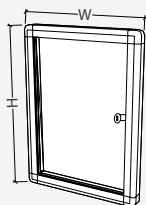

SIZES

14.092	250x400mm		
14.045	350x500mm		
14.046	500x700mm		
14.093	600x600mm		

HESSEN



BOARD DETAILS



INFORMATION

PROFILE DETAIL * mm

This showcase with aluminium frame and acrylic lockable door includes a metallic background. Featuring a side locker. This enclosed bulletin board provides a perfect display space for postings such as announcements or creative advertisements. The single lockable door ensures that documents, graphics or pictures stay clean and undisturbed.

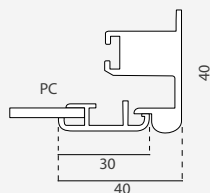

SIZES

14.087	500x700mm		
14.088	600x800mm		
14.089	700x1000mm		

WISSMAR



* Magnets at this page are available but not included.

BOARD DETAILS



DIMENSIONS

* mm

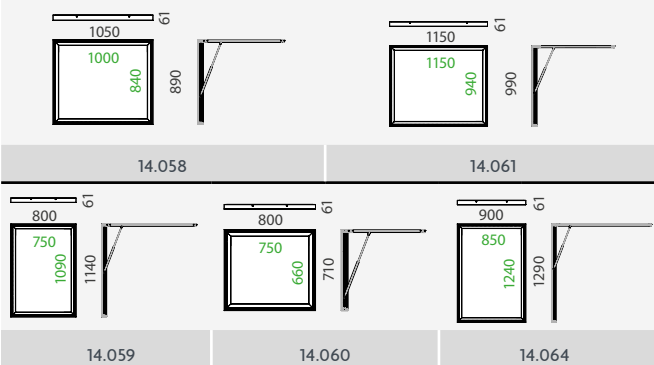

INFORMATION

PROFILE DETAIL

* mm

This showcase Metz is suitable for indoor or outdoor use. It features an aluminium frame, a magnetic background and a lockable door with side locker. Also there are 5 sizes available. The hinge always is mounted on width dimension. It is ideal to be mounted on the wall (hangers included) or directly to the floor using the base feet (which are available but sold separately).

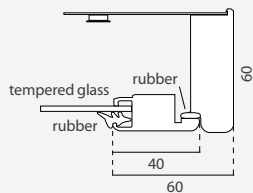

Aluminium thickness: 1.5mm to 1.8mm
Tempered Glass Thickness: 3mm

MODEL	WIDTH x HEIGHT
14.058	1000x840mm
14.059	750x1090mm
14.060	750x660mm
14.061	1150x940mm
14.064	850x1240mm

SHOWCASE METZ



* Base feet at this page are available but not included.

BOARD DETAILS



DIMENSIONS

PROFILE DETAIL

* mm

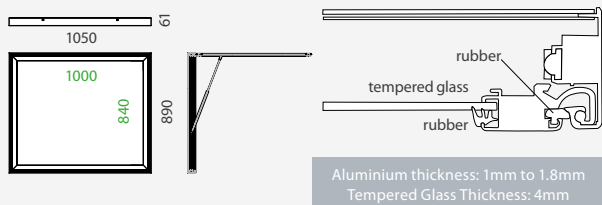

INFORMATION

This showcase Metz is suitable for indoor or outdoor use. It features an aluminium frame with a magnetic background and a lockable door with side locker. The hinge always is mounted on width dimension. This showcase is ideal to be mounted on the wall (hangers included) or directly to the floor using the base feet (which are available but sold separately).

MODEL WIDTH x HEIGHT

14.158  1050x890mm

OUTDOOR SHOWCASE
LED METZ



BASE DETAILS



INFORMATION

DIMENSIONS

* mm

The base feet are made of aluminium and they are suitable for mounting Metz showcases directly to the floor. The pack includes 2 aluminium poles, 2 endcaps and anchor pieces.

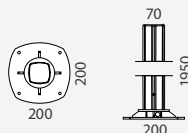

HEIGHT

14.081 Height: 1950mm x2 

BASE FEET

1.9m





Events

03

Complete range of promotional walls, counters and flag banners which provide an integral solution for the event exhibition.

- 106 SEG SYSTEM
- 110 POP UPS
- 123 POP UP ACCESSORIES
- 127 PROMOTION COUNTERS
- 141 TRADESHOW SYSTEMS
- 151 TRADESHOW FURNITURE
- 156 FLAG BANNERS
- 172 WALL BANNERS
- 178 REFILLABLE BASE BANNERS
- 183 SIDELINE BANNERS



POP UP DETAILS

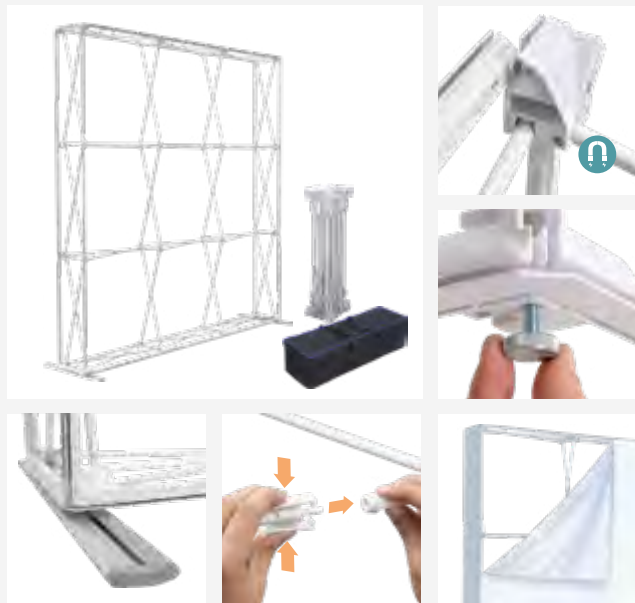

DIMENSIONS

*mm

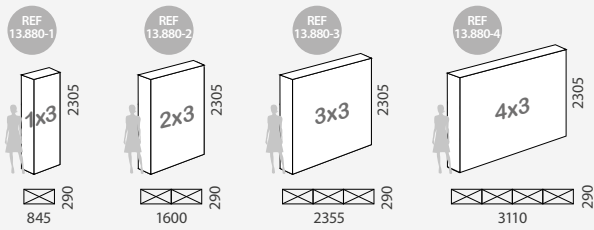

INFORMATION

Featuring a quick assembly white aluminium frame with magnetic bars for silicone edge textile graphics. Includes 2 attachable feet, silicone strip roll and bag. It can be turn into an backlit display with the optional LED Strip and Power Adapter (sold separately).

	QTY	N.W	G.W	C.B.M	SIZE
Packing	1	11kg	12kg	0.084	265x320x990mm
13.880-1	Graphic Sizes	Front-Back: 795x2215mm Sides: 275x2215mm Top-Bottom: 785x250mm			
	QTY	N.W	G.W	C.B.M	SIZE
Packing	1	13kg	14kg	0.084	265x320x990mm
13.880-2	Graphic Sizes	Front-Back: 1525x2215mm Sides: 275x2215mm Top-Bottom: 1510x250mm			
	QTY	N.W	G.W	C.B.M	SIZE
Packing	1	15.1kg	16.10kg	0.084	265x320x990mm
13.880-3	Graphic Sizes	Front-Back: 2255x2215mm Sides: 275x2215mm Top-Bottom: 2235x250mm			
	QTY	N.W	G.W	C.B.M	SIZE
Packing	1	17kg	18kg	0.084	265x320x990mm
13.880-4	Graphic Sizes	Front-Back: 2985x2215mm Sides: 275x2215mm Top-Bottom: 2960x250mm			

SEG POP UP



SEG POP UP SIZE	1x3	2x3	3x3	4x3	RECOMMENDED QUANTITIES*
Nº OF LED STRIPS	2	4	6	8	
Nº OF POWER ADAPTERS	1	1	2	2	



LED STRIP KIT FOR POP UP

INFORMATION

LED strip is the perfect solution to turn the SEG Pop Up into a backlight display. The set includes: 2 LED Strips **A** + 4 Clip Holders **B** + 1 Connect Cable **C**.

	QTY	N.W	G.W	C.B.M	SIZE
Packing	6	4.40kg	5.40kg	0.035	325x110x990
13.884	Length: 700mm		10 x 3.2W/LED	32W	



POWER ADAPTER SET

INFORMATION

This power adapter is compatible with 13.883 and 13.884. It has two different length output cables, one of 38cm and the other of 118cm. The set includes: 1 Power Adapter **A** + 1 Long Connect 2.3m Cable **B** + 6 Cable Clips **C**.

	QTY	N.W	G.W	C.B.M	SIZE
Packing	30	15kg	16kg	0.083	370x450x500mm
13.885	Input: 100-240V		Output: 24V/6.25A		



CARRY BAG FOR LED STRIPS

INFORMATION

Compatible with 13.883 and 13.884. Made of nylon and all crossed zipped features a custom cut EPE foam that protects and extends the life of your LED strips.

	QTY	N.W	G.W	C.B.M	SIZE
Packing	1	1kg	2kg	0.03	325x110x990mm
13.886	For 13.883 and 13.884 strips				

* The tablet stands at this page are available but not included.

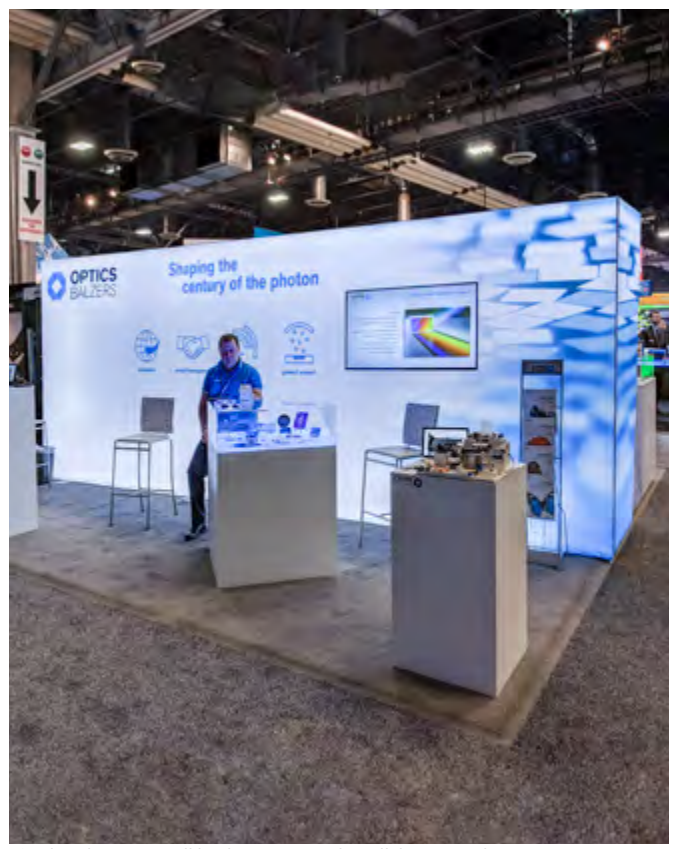

* Only indicative, it will be the customer who will determine the appropriate quantity.

TOTEM DETAILS



DIMENSIONS

*mm

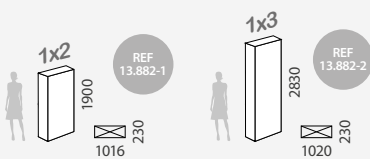

INFORMATION

Featuring a quick assembly white aluminium frame with magnetic bars for attaching silicone edge textile graphics. Includes 2 attachable feet, silicone strip roll and bag. Optional LED strip and Power Adapter (sold separately).

	QTY	N.W	G.W	C.B.M	SIZE
Packing	1	6.50kg	7.50kg	0.061	440x260x1080mm
13.882-1	Graphic Sizes	Front-Back: 1000x1890mm Sides: 240x1890mm Top-Bottom: 1000x240mm			
	QTY	N.W	G.W	C.B.M	SIZE
Packing	1	8.50kg	9.50kg	0.061	440x360x1080mm
13.882-2	Graphic Sizes	Front-Back: 1000x2830mm Sides: 240x2830mm Top-Bottom: 1000x240mm			

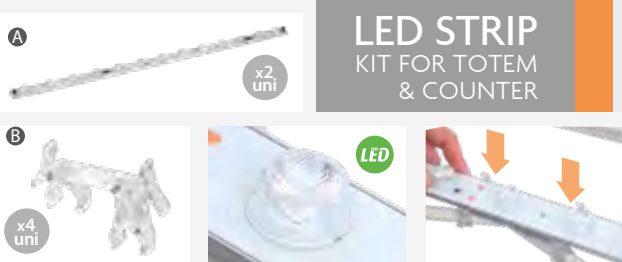

LED STRIP KIT FOR TOTEM & COUNTER

INFORMATION

This LED Strip Kit can be mounted in seconds thanks to its clip system. The LED Strip Kit includes: 2 LED Strips (A) + 4 Clip Holders (B).

	QTY	N.W	G.W	C.B.M	SIZE
Packing	2	2.50kg	3.50kg	0.016	120x110x1215mm
13.883	Length: 925mm	10 x 3.2W/LED	32W		

SEG TOTEM



POWER ADAPTER SET

INFORMATION

Compatible with 13.883 and 13.884. Includes: 1 Power Adapter (A) (with 2 output cables: 38cm and 118cm) + 1 Long Connect 2.3m Cable (B) + 6 Cable Clips (C).

	QTY	N.W	G.W	C.B.M	SIZE
Packing	30	15kg	16kg	0.083	370x450x500mm
13.885	Input: 100-240V	Output: 24V/6.25A			



CARRY BAG FOR LED STRIPS

INFORMATION

Compatible with 13.883 and 13.884. Made of nylon and all crossed zipped features a custom cut EPE foam that protects and extends the life of your LED strips.

	QTY	N.W	G.W	C.B.M	SIZE
Packing	1	1kg	2kg	0.03	325x110x990mm
13.886	For 13.883 and 13.884 strips				

COUNTER DETAILS



DIMENSIONS

*mm

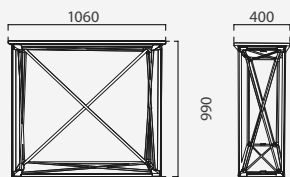

INFORMATION

SEG Counter features a white aluminium frame for attaching silicone edge textile graphics. Includes black or white countertop, silicone strip roll and carry bag. It can be turned into a backlit with the optional LED strip and Power Adapter (sold separately).

	QTY	N.W	G.W	C.B.M	SIZE
Packing	1	13.15kg	14.15kg	0.061	440x260x1080mm
13.881-1		Graphic	Front-Back: 1000x960mm Sides: 355x960mm		
13.881-2		Sizes	Top-Bottom: 1000x355mm		



LED STRIP
KIT FOR TOTEM
& COUNTER



INFORMATION

This LED Strip Kit can be mounted in seconds thanks to its clip system. The LED Strip Kit includes: 2 LED Strips **A** + 4 Clip Holders **B**.

	QTY	N.W	G.W	C.B.M	SIZE
Packing	2	2.50kg	3.50kg	0.016	120x110x1215mm
13.883	Length: 925mm	10 x 3.2W/LED	32W		

SEG COUNTER



POWER
ADAPTER SET

INFORMATION

Compatible with 13.883 and 13.884. Includes: 1 Power Adapter **A** (with 2 output cables: 38cm and 118cm) + 1 Long Connect 2.3m Cable **B** + 6 Cable Clips **C**.

	QTY	N.W	G.W	C.B.M	SIZE
Packing	30	15kg	16kg	0.083	370x450x500mm
13.885	Input: 100-240V	Output: 24V/6.25A			



CARRY BAG
FOR LED STRIPS

INFORMATION

Compatible with 13.883 and 13.884. Made of nylon and all crossed zipped features a custom cut EPE foam that protects and extends the life of your LED strips.

	QTY	N.W	G.W	C.B.M	SIZE
Packing	1	1kg	2kg	0.03	325x110x990mm
13.886	For 13.883 and 13.884 strips				

POP UP DETAILS

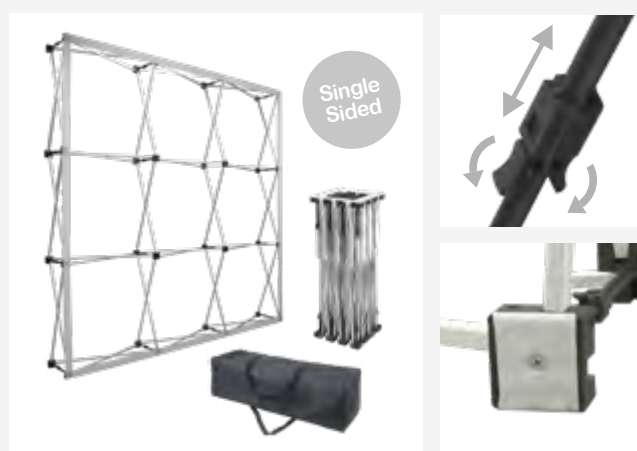

Single Sided

TEXTIL POP UP INSTALATION

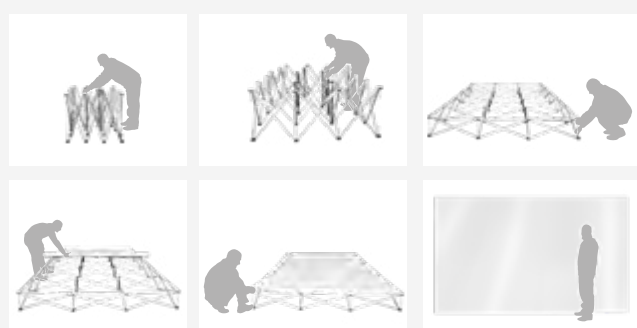

DIMENSIONS

*mm

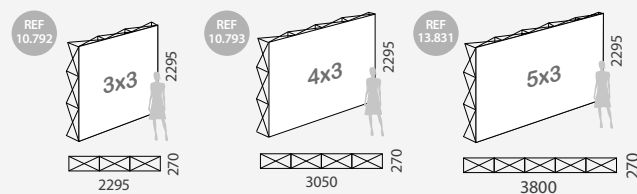

INFORMATION

Ipanema Pop-Up features an aluminium frame with locking arms for an easy assemble. Includes 1 soft-case nylon carry bag and 1 roll of genuine VELCRO® brand fasteners for attachment. This straight fabric Pop-Up is one of the most used options for photocalls. The graphics are simple to attach using the brand fasteners in its perimeter. Ideal for promotional acts, weddings, photocalls or at any stand booth.

IPANEMA 3x3	QTY	N.W	G.W	C.B.M	SIZE
Packing	1	7.40kg	8.70kg	0.055	300x220x830mm
10.792	3x3 Graphic Size: 2295x2295mm				

IPANEMA 4x3	QTY	N.W	G.W	C.B.M	SIZE
Packing	1	10kg	11kg	0.07	380x220x830mm
10.793	4x3 Graphic Size: 3050x2295mm				

IPANEMA 5x3	QTY	N.W	G.W	C.B.M	SIZE
Packing	1	11.6kg	13.2kg	0.07	830x220x380mm
13.831	5x3 Graphic Size: 3800x2295mm				

IPANEMA POP UP



* VELCRO® is a registered trademark of Velcro BVBA. | VELCRO® est une marque déposée de Velcro Industries B.V. | VELCRO® é uma marca registrada de Velcro Industries B.V. | VELCRO® es una marca registrada de VelcroIndustries B.V.

POP UP DETAILS

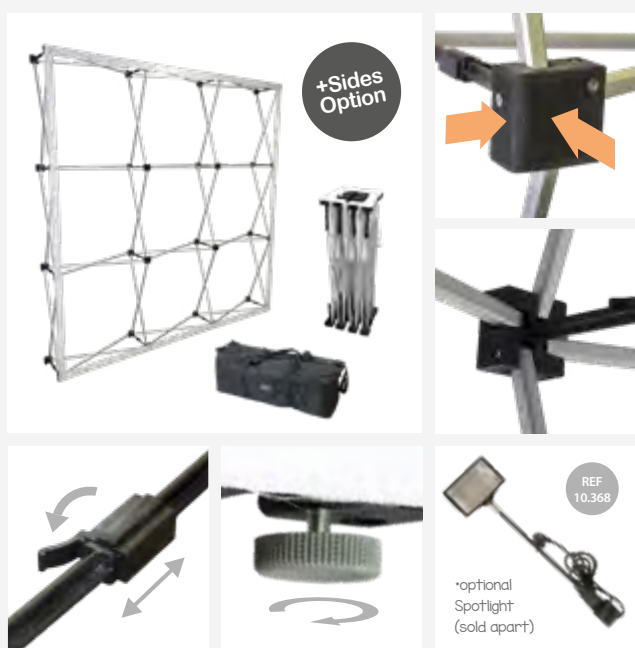

DIMENSIONS

*mm

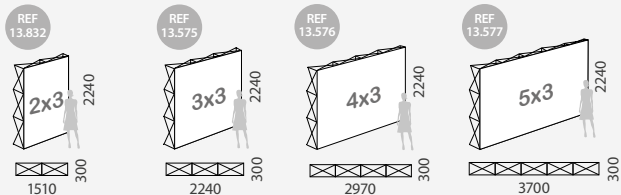

INFORMATION

Surat offers the possibility to fix the graph in the sides of the PopUp (consult the size of the graphics in these cases). Includes 1 soft-case nylon carry bag and 1 roll of genuine VELCRO® brand fasteners for attachment. Surat series feature leveling feet for a suitable adjustment of the PopUp on the surface of the floor.

SURAT 2X3	QTY	N.W	G.W	C.B.M	SIZE
Packing	1	9kg	10kg	0,0747	300x300x830mm
13.832	2x3 Graphic Front: 1510x2240mm Graphic (Front + Sides): 2110x2240mm				
SURAT 3X3	QTY	N.W	G.W	C.B.M	SIZE
Packing	1	9kg	10kg	0,0597	850x260x270mm
13.575	3x3 Graphic Front: 2240x2240mm Graphic (Front + Sides): 2840x2240mm				
SURAT 4X3	QTY	N.W	G.W	C.B.M	SIZE
Packing	1	11kg	12kg	0,0707	850x260x320mm
13.576	4x3 Graphic Front: 2970x2240mm Graphic (Front + Sides): 3570x2240mm				
SURAT 5X3	QTY	N.W	G.W	C.B.M	SIZE
Packing	1	13kg	14kg	0,0774	850x260x350mm
13.577	5x3 Graphic Front: 3700x2240mm Graphic (Front + Sides): 4300x2240mm				

SURAT POP UP



POP UP DETAILS

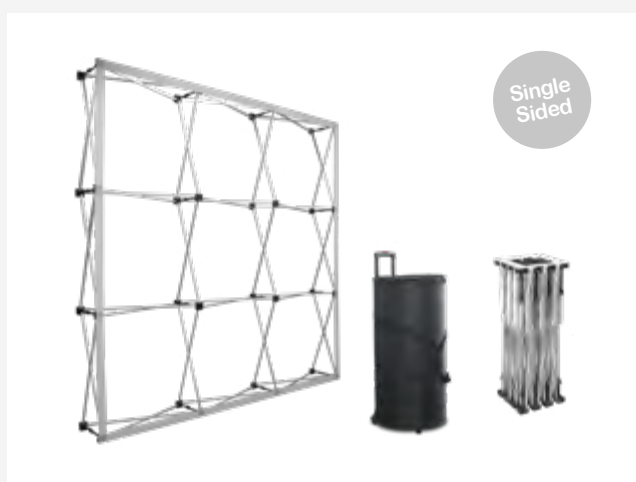

POP UP DETAILS



DIMENSIONS

*mm

REF 10.413

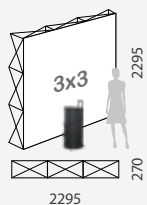

REF 10.414

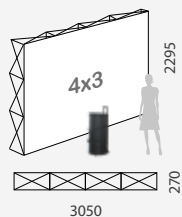

INFORMATION

Cangas Pop-Up is 5 sizes available, featuring an aluminium frame with locking arms for an easy assemble. It includes a trolley Carry Bag and 1 roll of genuine VELCRO® brand fasteners. This straight fabric Pop-Up is one of the most used options for photocalls. The graphics are simple to attach using the brand fasteners in its perimeter. Ideal for promotional acts, weddings, or just for displaying at any stand booth on media events.

CANGAS 3x3	QTY	N.W	G.W	C.B.M	SIZE
Packing	1	13.2kg	15kg	0.2	450x450x950mm
10.413	3x3 Graphic Size: 2295x2295mm				

CANGAS 4x3	QTY	N.W	G.W	C.B.M	SIZE
Packing	1	16.35kg	17.95kg	0.2	450x450x950mm
10.414	4x3 Graphic Size: 3050x2295mm				

CANGAS POP UP

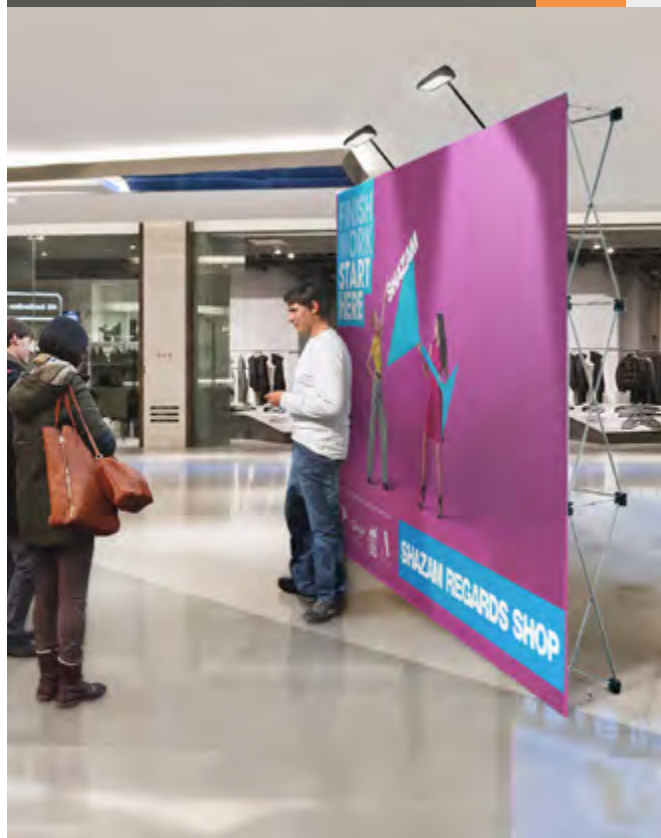

* Spotlights at this page are available but not included



* VELCRO® is a registered trademark of Velcro BVBA. | VELCRO® est une marque déposée de Velcro Industries B.V. | VELCRO® é uma marca registrada de Velcro Industries B. V. | VELCRO® es una marca registrada de VelcroIndustries B. V.

POP UP DETAILS



POP UP DETAILS

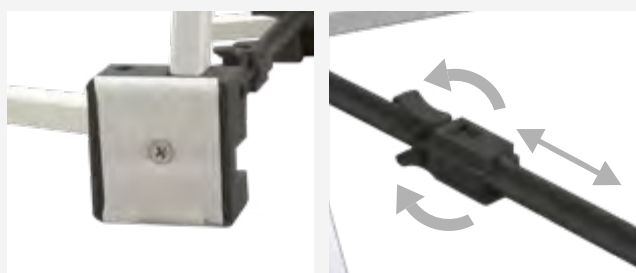

DIMENSIONS

*mm

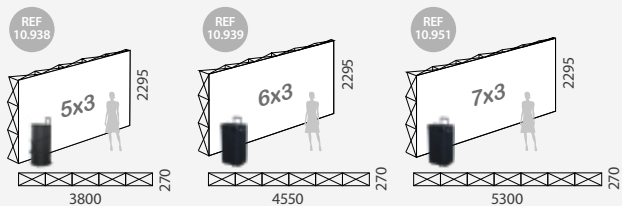

INFORMATION

This straight Textil Pop Up is one of the most used options for photocalls. The model 10.951 is the biggest (2.3x5.3m) Textile Pop Up available. It includes a trolley Carry Bag with wheels and 1 roll of genuine VELCRO® brand fasteners.

CANGAS 5x3	QTY	N.W	G.W	C.B.M	SIZE
Packing	1	16.95kg	18.3kg	0.201	460x460x950mm
10.938	5x3 Graphic Size: 3800x2295mm				
CANGAS 6x3	QTY	N.W	G.W	C.B.M	SIZE
Packing	1	16.50kg	18kg	0.178	440x440x920mm
10.939	6x3 Graphic Size: 4550x2295mm				
CANGAS 7x3	QTY	N.W	G.W	C.B.M	SIZE
Packing	1	16.5kg	18kg	0.18	440x440x930mm
10.951	7x3 Graphic Size: 5300x2295mm				

CANGAS POP UP



* Spotlights at this page are available but not included



POP UP DETAILS



POP UP INSTALATION

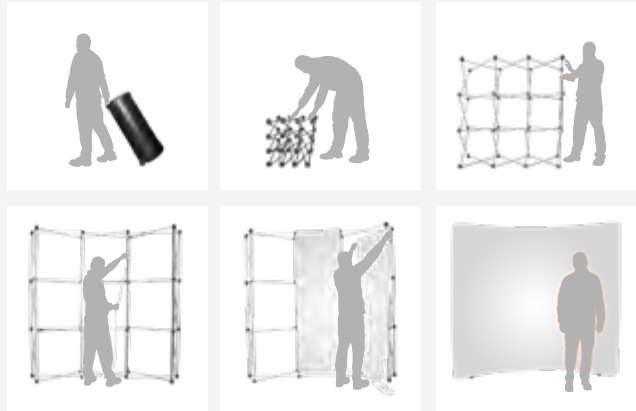

DIMENSIONS

*mm

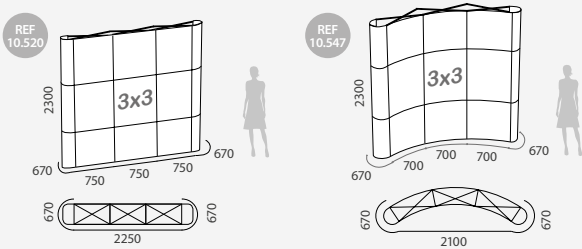

INFORMATION

Laredo 3x3 Pop Up features a straight or curved brushed aluminum frame that is lightweight, yet sturdy. Custom graphics attach to the frame with magnetic loop strips, yet with adhesive to the magnetic strip (1 strip roll is included). Also, 1 nylon trolley carry bag with wheels is included. This portable Pop Up can be set up and taken down in a few minutes. Ideal for enhancing your business's presence at your next media event, exhibition, tradeshow or convention.

3x3 STRAIGHT	QTY	N.W	G.W	C.B.M	SIZE
Packing	1	13kg	14kg	0.116	390x330x900mm
10.520	Graphic Size:		670x2300mm x2 750x2300mm x3		
3x3 CURVED	QTY	N.W	G.W	C.B.M	SIZE
Packing	1	13kg	14kg	0.116	390x330x900mm
10.547	Graphic Size:		670x2300mm x2 700x2300mm x3		

LAREDO 3x3



* Spotlights at this page are available but not included



* Spotlights at this page are available but not included

POP UP DETAILS



POP UP DETAILS



DIMENSIONS

*mm

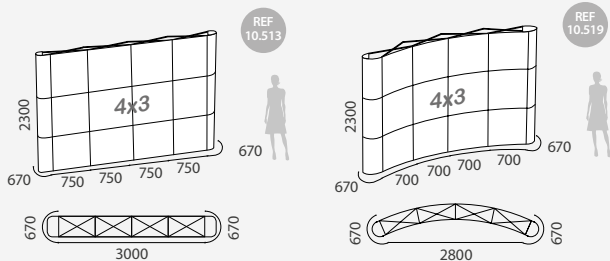

INFORMATION

Laredo 4x3 Pop Up features a straight or curved brushed aluminum frame that is lightweight, yet sturdy. Custom graphics attach to the frame with magnetic loop strips, yet with adhesive to the magnetic strip (1 strip roll is included). Also, 1 nylon trolley carry bag with wheels is included. This portable Pop Up can be set up and taken down in a few minutes. Ideal for enhancing your business's presence at your next media event, exhibition, tradeshow or convention.

4x3 STRAIGHT	QTY	N.W	G.W	C.B.M	SIZE
Packing	1	21.7kg	22.1kg	0.12	390x340x920mm
10.513	Graphic Size:		670x2300mm x2 750x2300mm x4		
4x3 CURVED	QTY	N.W	G.W	C.B.M	SIZE
Packing	1	14kg	15kg	0.116	390x330x900mm
10.519	Graphic Size:		670x2300mm x2 700x2300mm x4		

LAREDO 4x3



* Spotlights at this page are available but not included



* Spotlights at this page are available but not included

POP UP DETAILS



POP UP INSTALATION

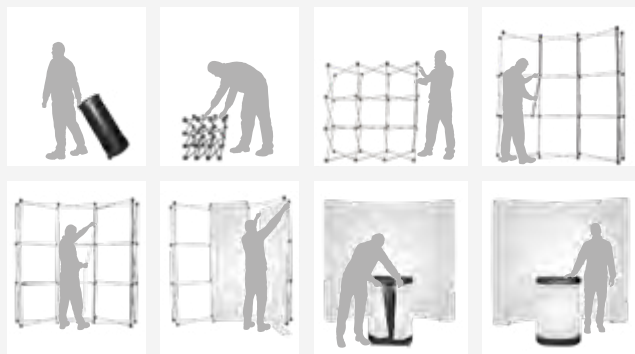

DIMENSIONS

*mm

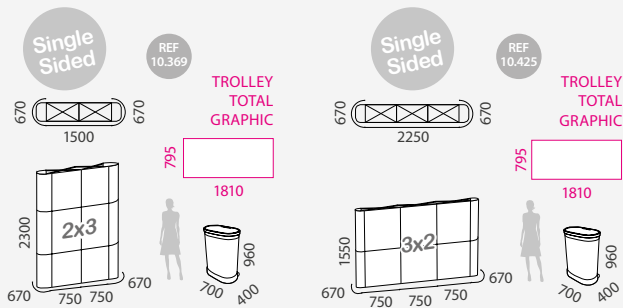

INFORMATION

Madrigal portable Pop Up features a 2x3 or 3x2 brushed aluminum frame that is lightweight, yet sturdy. Custom graphics attach to the frame with magnetic loop strips, yet with adhesive to the magnetic strip (1 strip roll is included). With 2 spotlights, also it includes 1 trolley hardcase with wheels that can be used as a customizable counter (printing is available but not included). Ideal for enhancing your business's presence at your next media event, exhibition, tradeshow or convention.

MADRIGAL 2x3	QTY	N.W	G.W	C.B.M	SIZE
Packing	1	27kg	28kg	0.284	700x410x990mm
10.369	Graphic Size:		670x2300mm x2 750x2300mm x2		

MADRIGAL 3x2	QTY	N.W	G.W	C.B.M	SIZE
Packing	1	28.8kg	32kg	0.32	720x430x1010mm
10.425	Graphic Size:		670x1550mm x2 750x1550mm x3		

MADRIGAL 2x3 | 3x2
STRAIGHT



POP UP DETAILS

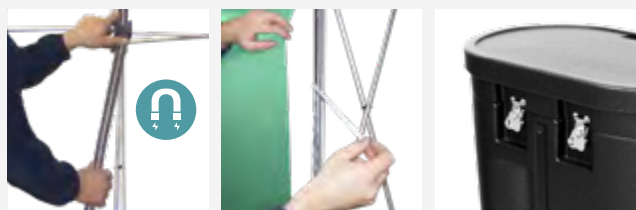

DIMENSIONS

*mm

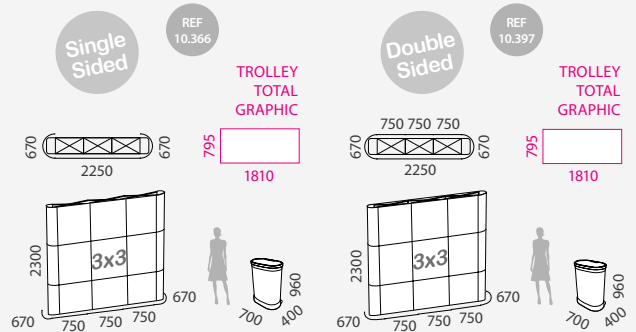

INFORMATION

Madrigal portable 3x3 Straight Pop Up features a brushed aluminum frame which is single-sided or double sided available. Custom graphics attach to the frame with magnetic loop strips, yet with adhesive to the magnetic strip (1 strip roll is included). With 2 spotlights, also it includes 1 trolley hard-case with wheels that can be used as a customizable counter (printing is available but not included). Ideal for enhancing your business's presence at your next media event, exhibition, tradeshow or convention.

3x3 1 SIDES	QTY	N.W	G.W	C.B.M	SIZE
Packing	1	32.25kg	35.45kg	0.32	730x430x1010mm
10.366	Graphic Size:		670x2300mm x2 750x2300mm x3		

3x3 2 SIDES	QTY	N.W	G.W	C.B.M	SIZE
Packing	1	34.75kg	37.95kg	0.32	730x430x1010mm
10.397	Graphic Size:		670x2300mm x2 750x2300mm x6		

MADRIGAL 3x3
STRAIGHT



POP UP DETAILS

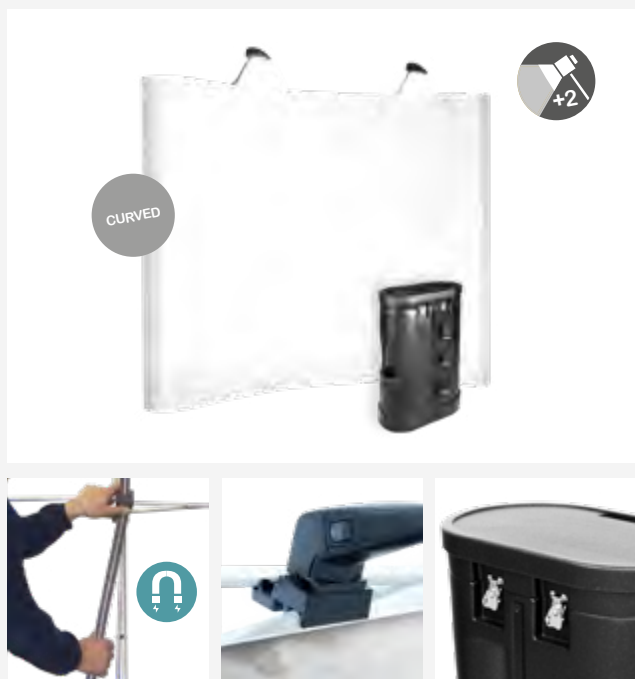

DIMENSIONS

*mm

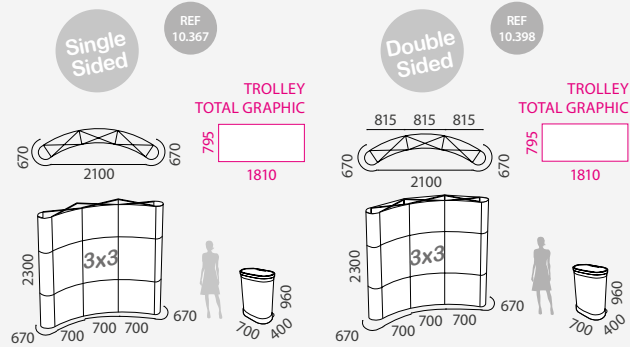

INFORMATION

Madrigal portable 3x3 Curved Pop Up features a brushed aluminum frame which is single-sided or double sided available. Custom graphics attach to the frame with magnetic loop strips, yet with adhesive to the magnetic strip (1 strip roll is included). With 2 spotlights, also it includes 1 trolley hard-case with wheels that can be used as a customizable counter (printing is available but not included). Ideal for enhancing your business's presence at your next media event, exhibition, tradeshow or convention.

3x3 1 SIDE C	QTY	N.W	G.W	C.B.M	SIZE
Packing	1	32.25kg	35.45kg	0.32	730x430x1010mm
10.367	Graphic Size:		670x2300mm x2 700x2300mm x3		

3x3 2 SIDES C	QTY	N.W	G.W	C.B.M	SIZE
Packing	1	34.75kg	37.95kg	0.32	730x430x1010mm
10.398	Graphic Size:		670x2300mm x2 700x2300mm x3 815x2300mm x3		

MADRIGAL 3x3
CURVED



POP UP DETAILS

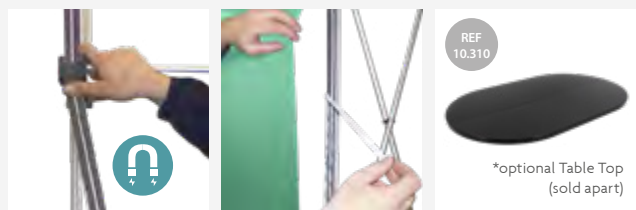

DIMENSIONS

*mm

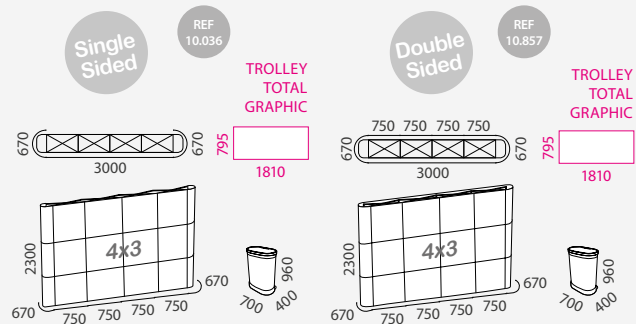

INFORMATION

Madrigal portable 4x3 Straight Pop Up features a brushed aluminum frame which is single-sided or double sided available. Custom graphics attach to the frame with magnetic loop strips, yet with adhesive to the magnetic strip (1 strip roll is included). With 2 spotlights, also it includes 1 trolley hard-case with wheels that can be used as a customizable counter (printing is available but not included). Ideal for enhancing your business's presence at your next media event, exhibition, tradeshow or convention.

4x3 1SIDE S	QTY	N.W	G.W	C.B.M	SIZE
Packing	1	36.3kg	39.5kg	0.32	730x430x1010mm
10.036	Graphic Size:		670x2300mm x2 750x2300mm x4		

4x3 2SIDES S	QTY	N.W	G.W	C.B.M	SIZE
Packing	1	44.5kg	47.7kg	0.32	730x430x1010mm
10.857	Graphic Size:		670x2300mm x2 750x2300mm x8		

MADRIGAL 4x3
STRAIGHT



POP UP DETAILS



DIMENSIONS

*mm

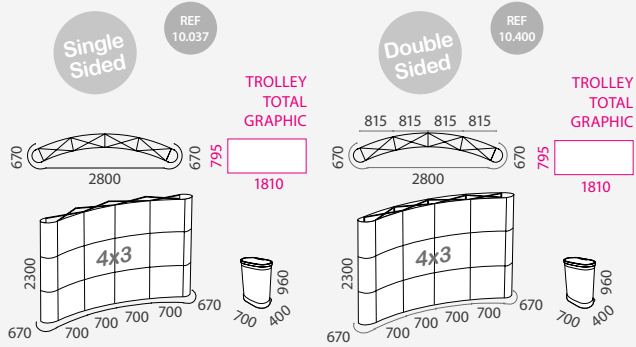

INFORMATION

Madrigal portable 4x3 Curved Pop Up features a brushed aluminum frame which is single-sided or double sided available. Custom graphics attach to the frame with magnetic loop strips, yet with adhesive to the magnetic strip (1 strip roll is included). With 2 spotlights, also it includes 1 trolley hard-case with wheels that can be used as a customizable counter (printing is available but not included). Ideal for enhancing your business's presence at your next media event, exhibition, tradeshow or convention.

4x3 1 SIDE C	QTY	N.W	G.W	C.B.M	SIZE
Packing	1	27kg	28kg	0.284	700x410x990mm
10.037	Graphic Size:		670x2300mm x2 700x2300mm x4		

4x3 2 SIDES C	QTY	N.W	G.W	C.B.M	SIZE
Packing	1	44.5kg	47.7kg	0.32	710x430x1010mm
10.400	Graphic Size:		670x2300mm x2 700x2300mm x4 815x2300mm x4		

MADRIGAL 4x3
CURVED



POP UP DETAILS

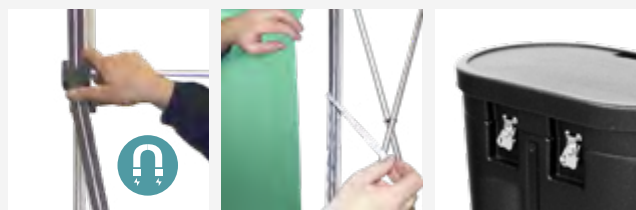

DIMENSIONS

*mm

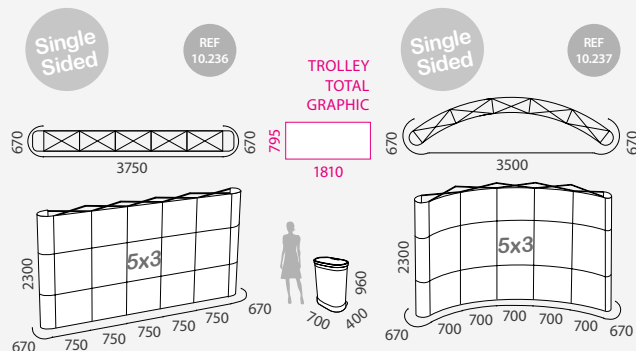

INFORMATION

Madrigal portable 5x3 Pop Up features a brushed aluminum frame which is straight shaped or curved shaped available. Custom graphics attach to the frame with magnetic loop strips, yet with adhesive to the magnetic strip (1 strip roll is included). With 2 spotlights, also it includes 1 trolley hard-case with wheels that can be used as a customizable counter (printing is available but not included). Ideal for enhancing your business's presence at your next media event, exhibition, tradeshow or convention.

5x3 STRAIGHT	QTY	N.W	G.W	C.B.M	SIZE
Packing	1	40.1kg	43.3kg	0.32	730x430x1010mm
10.236	Graphic Size:		670x2300mm x2 750x2300mm x5		

5x3 CURVED	QTY	N.W	G.W	C.B.M	SIZE
Packing	1	40.1kg	43.3kg	0.32	730x430x1010mm
10.237	Graphic Size:		670x2300mm x2 700x2300mm x5		

MADRIGAL 5x3



POP UP DETAILS

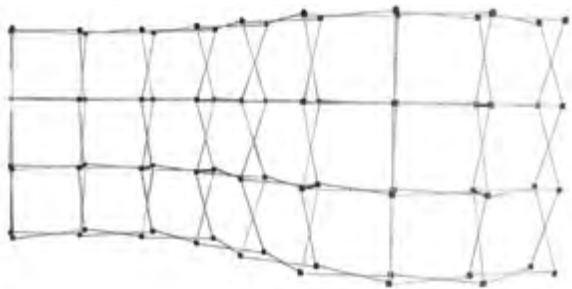

DIMENSIONS

*mm

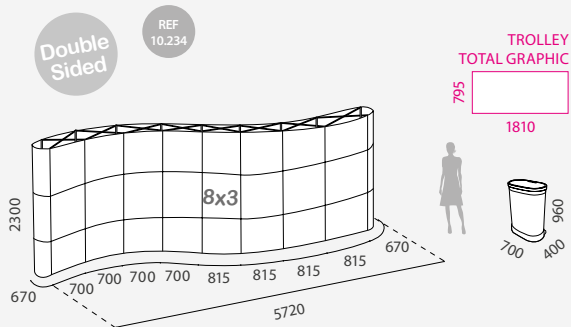

INFORMATION

Teide 8x3 double sided display is the biggest Pop Up, featuring a brushed aluminum frame. Custom graphics attach to the frame with magnetic loop strips, yet with adhesive to the magnetic strip (1 strip roll is included). With 4 spotlights for accenting your graphics. Also, it includes 2 trolley hard-cases with wheels that can be used as counters, and wraps for the cases can be customized with printed graphics (printing is available but not included). Ideal for enhancing your business's presence at your next media event, exhibition, tradeshow or convention.

TEIDE S	QTY	N.W	G.W	C.B.M	SIZE
Packing	2	35.6kg 30kg	36.6kg 31kg	0.32 0.32	730x430x1010mm 730x430x1010mm
10.234	Graphic Size:		670x2300mm x2 700x2300mm x8 815x2300mm x8		

TEIDE 8x3

Biggest Pop-Up

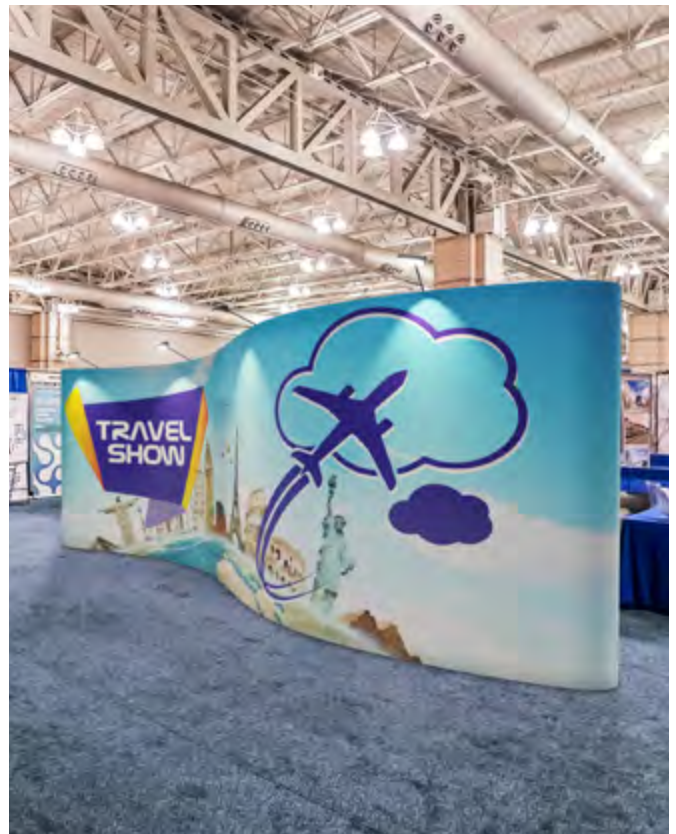

POP UP ACCESSORIES Trolleys and Cases | Table Top

ESCALONA SOFT-CASE TROLLEY

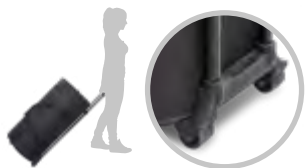
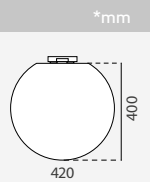

INFORMATION

Made of Nylon with closures and zippers, 2 handle straps, 1 extendable handle and wheels. Escalona is ideal for protecting and transporting Pop Ups.

ESCALONA	QTY	N.W	G.W	C.B.M	SIZE
Packing	1	15kg	18.6kg	0.12	680x170x1030mm
10.060	Trolley Size: 420x420x790mm				

NOVES HARD-CASE TROLLEY

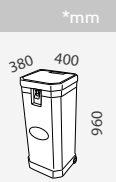

INFORMATION

Made of hard PVC, design lasts through long-term uses. Includes high-quality clasps and rubber wheels. Ideal for being labelled and used as counter.

NOVES	QTY	N.W	G.W	C.B.M	SIZE
Packing	1	7kg	9.1kg	0.18	410x430x1000mm
10.059	Graphic size for Counter: 1450x745mm				

MAQUEDA TROLLEY HARD-CASE

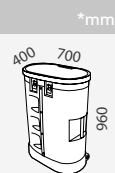

INFORMATION

Made of hard PVC, design lasts through long-term uses. Includes high-quality clasps, rubber wheels and handles. Ideal for carrying case makes easy to transport your trade show accessories and exhibits in between events.

MAQUEDA	QTY	N.W	G.W	C.B.M	SIZE
Packing	1	13kg	15.2kg	0.32	710x420x1010mm
10.058	Trolley: 700x400x960mm Graphic: 1810x795mm				

TABLE TOP FOR POP UP



INFORMATION

Includes nylon carry bag with ID Pocket and handles. Black or Silver color available. Foldable for transportation. Ideal to consolidate your trolley as a promotional counter, providing more surface to display in your event presentation.

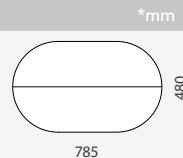
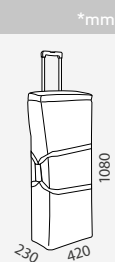

TABLE TOP	QTY	N.W	G.W	C.B.M	SIZE
Uni.	1	4.2kg	5.0kg	0.05	830x270x220mm
10.309	785x480x16mm				
10.310					

TROLLEY SOFT-CASE



INFORMATION

Trolley made of black nylon with closures and zippers, 2 handle straps, 1 extendable handle and wheels.

TROLLEY S.C.1	QTY	N.W	G.W	C.B.M	SIZE
Packing	1	3.75kg	5.7kg	0.13	455x265x1160mm
13.456	420x230x1080mm				

TROLLEY SOFT-CASE

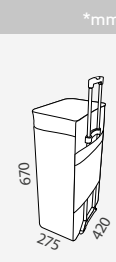

INFORMATION

Trolley made of black nylon with closures and zippers, 2 handle straps, 1 extendable handle and wheels.

TROLLEY S.C.2	QTY	N.W	G.W	C.B.M	SIZE
Packing	1	4.15kg	5.5kg	0.12	440x340x820mm
13.457	420x275x670mm				

* Counter is not included / Présentoir non inclus / Balcão não incluídos / Mostrador no incluido.

* Counter is not included / Présentoir non inclus / Balcão não incluídos / Mostrador no incluido.

TOP AND BOTTOM BAR GRAPHIC (3x3)

- EN Top and bottom bars pack for Pop Up 3x3.
- FR Kit de bandes de suspension pour Pop Up 3x3.
- PT Kit de tiras de suspensão para Pop Up 3x3.
- ES Pack de Perchas/Zócalos para Pop Up 3x3.



INFORMATION 3x3 Pop Ups

- Available Pack of 10 bars for **Straight 3x3 Pop Up** (5 Bottom and 5 Top).
- Available Pack of 6 bars for **Back curved 3x3 Pop Up** (3 Bottom and 3 Top).
- Available Pack of 10 bars for **Front curved 3x3 Pop Up** (5 Bottom and 5 Top).

STRAIGHT BAR	QTY	N.W	G.W	C.B.M	SIZE
Packing	10	0.68kg	0.7kg	0.0008	55x20x750mm
10.714	Straight 3x3	Pack: 5 Bottom + 5 Top			

C.FRONT BAR	QTY	N.W	G.W	C.B.M	SIZE
Packing	10	0.7kg	0.72kg	0.0007	55x20x700mm
10.715	Curved/Front 3x3	Pack: 5 Bottom + 5 Top			

C.BACK BAR	QTY	N.W	G.W	C.B.M	SIZE
Packing	6	0.46kg	0.48kg	0.0004	55x10x810mm
10.491	Curved/Back 3x3	Pack: 3 Bottom + 3 Top			

TOP AND BOTTOM BAR GRAPHIC (4x3)

- EN Top and bottom bars pack for Pop Up 4x3.
- FR Kit de bandes de suspension pour Pop Up 4x3.
- PT Kit de tiras de suspensão para Pop Up 4x3.
- ES Pack de Perchas/Zócalos para Pop Up 4x3.

INFORMATION 4x3 Pop Ups

- Available Pack of 12 bars for **Straight 4x3 Pop Up** (6 Bottom and 6 Top).
- Available Pack of 8 bars for **Back curved 4x3 Pop Up** (4 Bottom and 4 Top).
- Available Pack of 12 bars for **Front curved 4x3 Pop Up** (6 Bottom and 6 Top).

STRAIGHT BAR	QTY	N.W	G.W	C.B.M	SIZE
Packing	12	0.83kg	0.85kg	0.0008	55x20x750mm
10.716	Straight 4x3	Pack: 6 Bottom + 6 Top			

C.FRONT BAR	QTY	N.W	G.W	C.B.M	SIZE
Packing	12	0.78kg	0.8kg	0.0007	55x20x700mm
10.717	Curved/Front 4x3	Pack: 6 Bottom + 6 Top			

C.BACK BAR	QTY	N.W	G.W	C.B.M	SIZE
Packing	8	0.6kg	0.62kg	0.0004	55x15x810mm
10.492	Curved/Back 4x3	Pack: 4 Bottom + 4 Top			

MAGNETIC BAR

- EN Magnetic bar. Suitable for models: Madrigal, Gredos, Arévalo, Laredo and Llanes.
- FR Barre magnétique. Compatible avec: Madrigal, Gredos, Arevalo, Laredo et Llanes.
- PT Barra magnética compatível com: Madrigal, Gredos, Arevalo, Laredo, LLanes.
- ES Barra magnética. Válida en modelos: Madrigal, Gredos, Arévalo, Laredo y Llanes.



720mm bar For Pop Up

INFORMATION

- See model of Pop Up for compatibility.
- With rail to insert the adhesive magnetic strip.
- Bars for construction of magnetic structures for Pop Ups.

MAGNETIC BAR	QTY	N.W	G.W	C.B.M	SIZE
Packing	1	0.2kg	0.22kg	0.0003	50x10x760mm 
10.419	720mm				

MAGNETIC STRIP ROLL 12mm



- EN Magnetic strip roll, 50 metres length for fixing Pop Up graphics.
- FR Rouleau magnétique de 50m pour la fixation des images au Pop Up.
- PT Rolo magnético com 50 metros para fixar impressões de Pop Up.
- ES Rollo de imán de 50 metros para la fijación de gráficas de Pop Up.

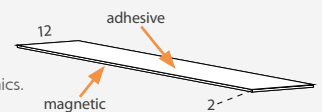

INFORMATION

- 50m Roll.
- 2mm thickness strip.
- One adhesive side for fixing to the graphics.



M.STRIP ROLL	QTY	N.W	G.W	C.B.M	SIZE
Packing	1	3.4kg	3.82kg	0.0038	390x25x390mm  
10.360	50m roll				

POP UP ACCESSORIES Assembly Pieces | PVC Panel

PVC PANNEL FOR POP UPS



high-quality
white 0.4mm PVC

CONNECTING PIECES FOR POP UPS

EN PVC pannel for Pop Up.
FR Panneau en PVC pour Pop Up.

PT Painel de PVC para Pop Up.
ES Panel de PVC para Pop Up.

INFORMATION

*mm

- Made of 0.4mm white PVC.
- Ideal for printing graphics for Pop Up.

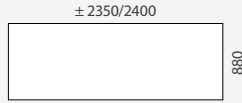

PVC PANNEL	QTY	N.W	G.W	C.B.M	SIZE	
Packing	1	0.80kg	1kg	0.06	2440x130x200mm	express
10.101		±2350/2400x880x0.4mm				

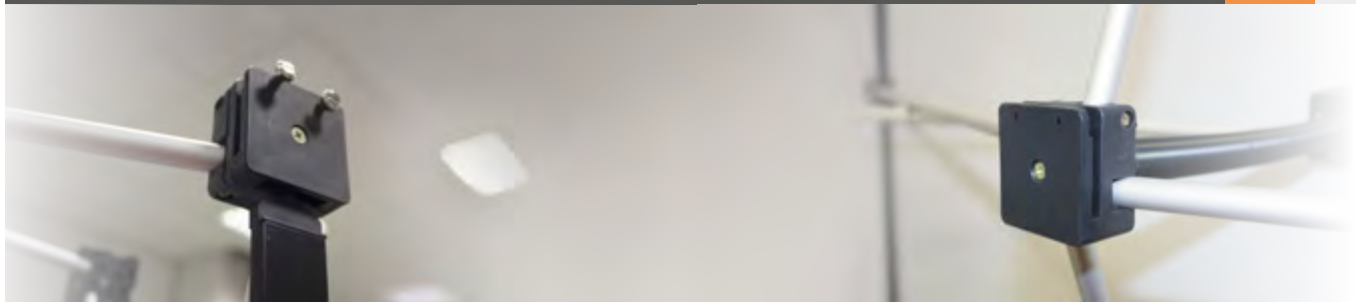

PLASTIC PIECE FOR MAGNETIC BAR

PLASTIC PIECE FOR POP UP CORNER

PLASTIC PIECE FOR BAR GRAPHICS

*mm

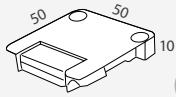

REF 10.858

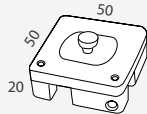
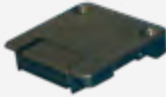

REF 10.409

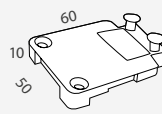

REF 10.859



PIECE M	QTY	N.W	G.W	C.B.M	SIZE
Packing	1	0.014kg	0.015kg	0.00002	50x10x50mm
10.858		50x50x10mm			

CORNER	QTY	N.W	G.W	C.B.M	SIZE
Packing	1	0.038kg	0.039kg	0.00007	50x30x50mm
10.409		50x50x20mm			

PIECE B	QTY	N.W	G.W	C.B.M	SIZE
Packing	1	0.02kg	0.021kg	0.00006	55x20x60mm
10.859		60x50x10mm			

CROSS FOR TEXTIL POP UPS



INFORMATION

Cross of replacement for structures on Pop Ups with genuine VELCRO® brand system.

CROSS F.P.U.	QTY	N.W	G.W	C.B.M	SIZE
Packing	1	0.70kg	0.80kg	0.005	80x80x800mm
96.117					

HORIZONTAL CROSS FOR MAGNETIC POP UPS



INFORMATION

One unit cross of replacement for structures on Pop Ups with magnetic system.

HORIZONTAL C.	QTY	N.W	G.W	C.B.M	SIZE
Packing	1	0.70kg	0.80kg	0.005	80x80x800mm
10.897					

* VELCRO® is a registered trademark of Velcro BVBA. | VELCRO® est une marque déposée de Velcro Industries B.V. | VELCRO® é uma marca registrada de Velcro Industries B.V. | VELCRO® es una marca registrada de VelcroIndustries B.V.

SPOTLIGHT DETAILS





INFORMATION

*mm

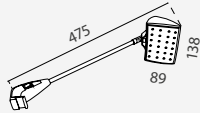
- Clamp base.
- 10W LED light included.
- Ideal for illuminating your exhibit booth and shed light on your displayed products and promotions.



ECONOMIC L.S.	QTY	N.W	G.W	C.B.M	SIZE	
Packing	30	0.3kg	11kg	0.1028	605x515x330mm	
13.753			10 W		18V	

ECONOMIC LED SPOTLIGHT FOR POP UP



SPOTLIGHT FOR POP UP



INFORMATION

*mm

- Double clamp base.
- 150w light included.
- Ideal for illuminating your exhibit booth and shed light on your displayed products and promotional services.

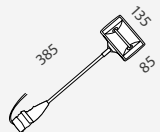

SPOTLIGHT	QTY	N.W	G.W	C.B.M	SIZE
Packing	1	0.65kg	0.7kg	0.0038	150x50x510mm
10.368			150 w		

OXFORD BAG FOR POP UP SPOTLIGHTS

BAG DETAILS



easy transport by handle



INFORMATION

*mm

- Made of black nylon and all crossed zipped.
- The Oxford Bag protects and extends the life of your Pop Up Spotlights. Easy transport by handles.

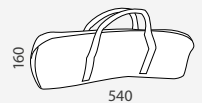

OXFORD BAG	QTY	N.W	G.W	C.B.M	SIZE
Packing	1	0.15kg	0.20kg	0.002	160x30x540mm
13.455					

* Spotlights not included / *Spotlights non inclus / *Focos não incluídos / *Focos no incluidos.

COUNTER DETAILS



COUNTER DETAILS



DIMENSIONS

ARTWORK

*mm

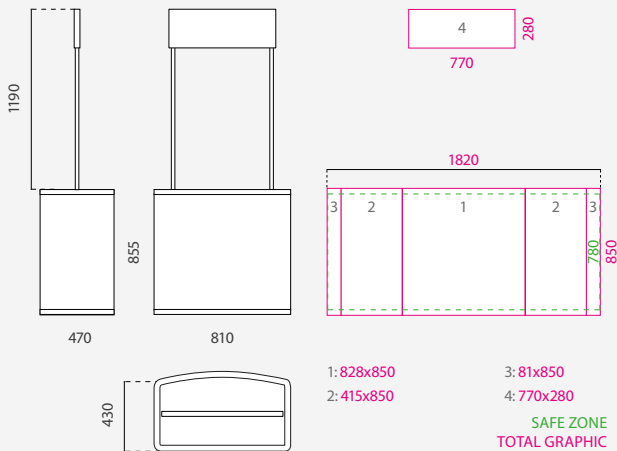

INFORMATION

This counter comes with carry bag and exhibitors can quickly assemble it in a few minutes (no tools required). Once it has been assembled, the counter is lightweight enough to be moved with ease by one person. It has 1 plastic shelf in the interior, so the extra brochures, business cards and flyers can be stored out of sight so your exhibition always appears clean and organized. This counter has a header of 770x280mm for displaying company logos or graphs. Each counter that comes with a header, is excellent for tradeshows and promotional events at stores or business presentations.

TAVIRA	QTY	N.W	G.W	C.B.M	SIZE
Packing	1	6.50kg	7.50kg	0.082	850x110x865mm

10.098 Total Size Counter: 810x470x2045mm

TAVIRA



COUNTER DETAILS



DIMENSIONS

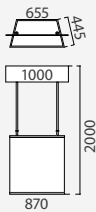

ARTWORK

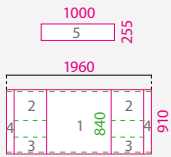

*mm

SAFE ZONE
TOTAL GRAPHIC

- 1: 870x910
- 2: 445x435
- 3: 445x240
- 4: 100x910
- 5: 1000x255

INFORMATION

The Salmoral Counter has 1 plastic shelf in the interior of the display for a better storing and it includes a nylon carry bag. This lightweight counter has a header of 1000x255mm for displaying company logos or graphs. Exhibitors can quickly assemble it in less than 5 minutes (no tools required). Excellent for tradeshows and promotional acts at stores, supermarkets or for business presentations.

SALMORAL	QTY	N.W	G.W	C.B.M	SIZE
Packing	1	6.8kg	8.25kg	0.051	560x70x1300mm
10.043	Total Size Counter: 1000x434x2000mm				

SALMORAL



COUNTER DETAIL

DIMENSIONS

ARTWORK *mm

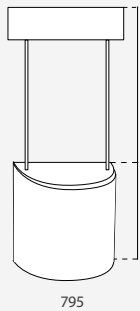

SAFE ZONE
TOTAL GRAPHIC

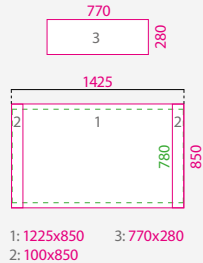

- 1: 1225x850
- 2: 100x850
- 3: 770x280

INFORMATION

This counter comes with carry bag and exhibitors can quickly assemble it in a few minutes (without tools). It has 1 plastic shelf in the interior of the display. Belvis features an accessible semicircular design. This counter has a header of 770x280mm for displaying company logos or graphs. Ideal for tradeshows and promotional events at any stores or business presentations.

BELVIS	QTY	N.W	G.W	C.B.M	SIZE
Packing	1	5.7kg	7kg	0.082	850x110x865mm
10.719	Total Size Counter: 795x440x2075mm				

BELVIS



COUNTER DETAIL DIMENSIONS ARTWORK *mm

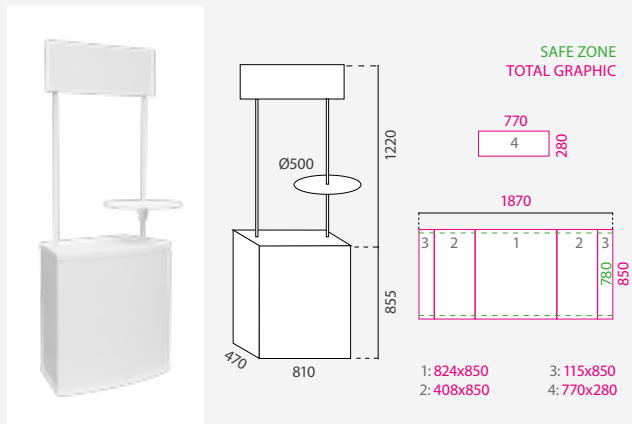

INFORMATION

This counter comes with carry bag and exhibitors can quickly assemble it in a few minutes (no tools required). It has 1 circular Ø500mm shelf for one pole and 1 plastic shelf in the interior of the display. This counter has a header of 770x280mm for displaying company logos or graphs. It is excellent for tradeshows and promotional events at stores or business presentations.

MANCHESTER	QTY	N.W	G.W	C.B.M	SIZE
Packing	1	9.5kg	10.5kg	0.08	860x110x880mm
10.676	Total Size Counter: 810x470x2075mm				

MANCHESTER



COUNTER DETAIL DIMENSIONS ARTWORK *mm

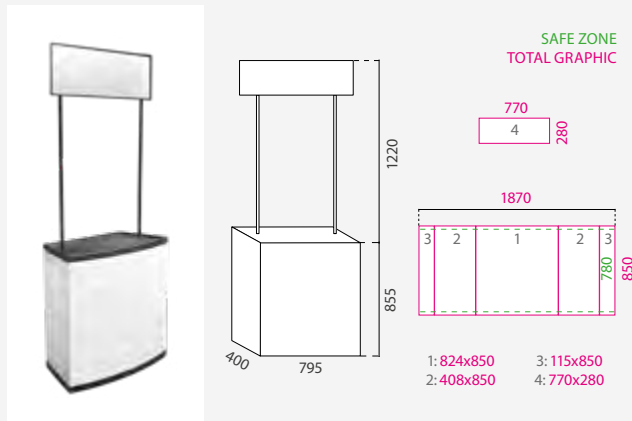

INFORMATION

This counter comes with carry bag and exhibitors can quickly assemble it in less than 5 minutes (no tools required). It has 1 plastic shelf in the interior of the display. Featuring a sleek blacklened look design, allowing the display to stand out against any background. With a displaying header of 770x280mm, Lake Counter is excellent for tradeshows, stores or business presentations.

LAKE	QTY	N.W	G.W	C.B.M	SIZE
Packing	1	8.5kg	9.5kg	0.08	860x110x880mm
10.675	Total Size Counter: 795x400x2075mm				

LAKE



COUNTER DETAILS



ARTWORK *mm

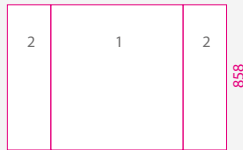
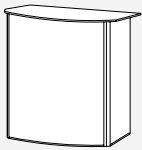

TOTAL GRAPHIC

1: 1004x858
2: 322x858

INFORMATION

This Counter has an aluminium frame and two internal shelves to give the promo stands support and provide storage space. Also it features 2 lockable doors. The top counter shelf has a wooden finish, yet attractive display. It is assembled and disassembled quickly and stored into a carrying bag.

SIGÜENZA	QTY	N.W	G.W	C.B.M	SIZE
Packing	1	27kg	30kg	0.23	950x200x1250mm
10.493					

SIGÜENZA



COUNTER DETAILS



ARTWORK *mm

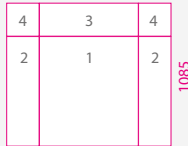
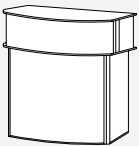

TOTAL GRAPHIC

1: 1004x858 3: 1122x227
2: 322x858 4: 212x227

INFORMATION

The Sepulveda Counter has an aluminium frame and 3 shelves (2 internal) to give the stands support and provide storage space, with third shelf the counter has an added desk. Also features 2 lockable doors. The top counter shelf has a wooden finish. It is assembled and disassembled quickly and stored into a carrying bag

SEPULVEDA	QTY	N.W	G.W	C.B.M	SIZE
Packing	1	36.8kg	41.9kg	0.18	940x160x1190mm
10.494					

SEPULVEDA



COUNTER DETAILS

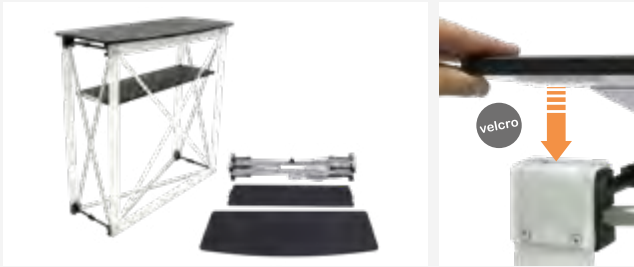

DIMENSIONS

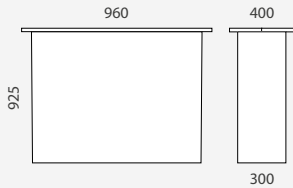

ARTWORK

*mm

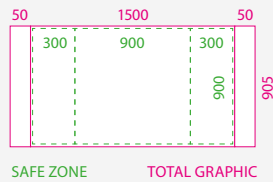

INFORMATION

Ajalvir is a very fast assembly counter thanks to its genuine VELCRO® brand fasteners system. Features 2 blackened wooden shelves (foldable top) and a carry bag. Ideal for tradeshows, promotional events at stores or business presentations.

AJALVIR	QTY	N.W	G.W	C.B.M	SIZE
Packing	1	8.35kg	9.15kg	0.0609	290x210x1000mm
10.323	Graphic Size: 905x1600mm				

AJALVIR



COUNTER DETAILS



DIMENSIONS

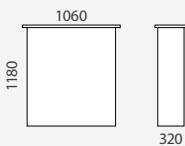

ARTWORK

*mm

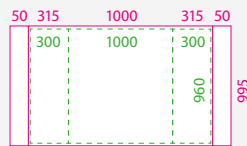

SAFE ZONE
TOTAL GRAPHIC

INFORMATION

Villares is a very fast assembly counter thanks to its genuine VELCRO® brand fasteners system. Features 2 blackened wooden shelves (foldable top) and a carry bag. Ideal for tradeshows, promotional events at stores or business presentations.

VILLARES	QTY	N.W	G.W	C.B.M	SIZE
Bottom	1	3.1kg	6.85kg	0.12	445x230x130mm
Top	1	5.45kg	6.6kg	0.04	465x70x120mm
10.096	Graphic Size: 1730x995mm				

VILLARES



COUNTER DETAILS



DIMENSIONS

ARTWORK

*mm

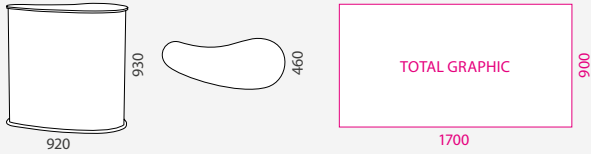

INFORMATION

Cezures counter features a black wooden countertop and base. A carrying bag with handles is included. It can be used to hold promotional materials, also known as a portable stand, can be used to conduct a product demonstration. Easy and fast to set up thanks to its genuine VELCRO® brand fasteners system.

CEZURES	QTY	N.W	G.W	C.B.M	SIZE
Packing	2	7.7kg	12kg	0.02	570x380x940mm
10.686	Graphic Size: 1700x900mm				

CEZURES



COUNTER DETAILS



DIMENSIONS

ARTWORK

*mm

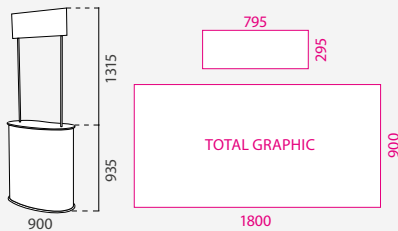

INFORMATION

The Atenas Counter features a black wooden countertop and base. Also, it has 1 plastic shelf in the interior and a top header of 795x295mm for displaying your message. A fabric carrying bag with handles is included. Easy and fast to set up thanks to its genuine VELCRO® brand fasteners system. It is ideal for being used at tradeshows, media events or business presentations.

ATENAS	QTY	N.W	G.W	C.B.M	SIZE
Packing	1	25.8kg	27kg	0.21	500x440x940mm
10.312	Graphic Size: 1800x900mm				

ATENAS



* VELCRO® is a registered trademark of Velcro BVBA. | VELCRO® est une marque déposée de Velcro Industries B.V. | VELCRO® é uma marca registrada de Velcro Industries B.V. | VELCRO® es una marca registrada de Velcro Industries B. V.

COUNTER DETAILS

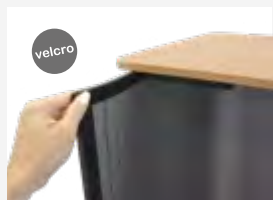

CAEN



DIMENSIONS

ARTWORK

*mm

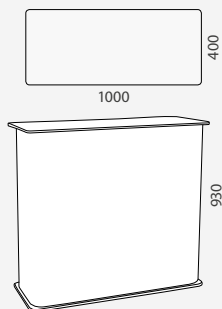

TOTAL GRAPHIC



INFORMATION

This counter comes with carry bag and exhibitors can quickly assemble it in a few minutes (no tools required) thanks to its genuine VELCRO® brand fasteners system. Once it has been assembled, the counter is lightweight enough to be moved with ease by one person. It has 1 shelf in the interior, so the extra brochures, business cards and flyers can be stored out of sight so your exhibition always appears clean and organized. This counter features wood or black finish available. Ideal for tradeshow and promotional events at stores or business presentations.



CAEN	QTY	N.W	G.W	C.B.M	SIZE
Packing	1	16kg	19kg	0.2012	1290x300x520mm

13.845-1  Graphic Size: 1900x900mm

13.845-2  Graphic Size: 1900x900mm

* VELCRO® is a registered trademark of Velcro BVBA. | VELCRO® est une marque déposée de Velcro Industries B.V. | VELCRO® é uma marca registrada de Velcro Industries B.V. | VELCRO® es una marca registrada de Velcro Industries B.V.

COUNTER DETAILS



DIMENSIONS

ARTWORK *mm

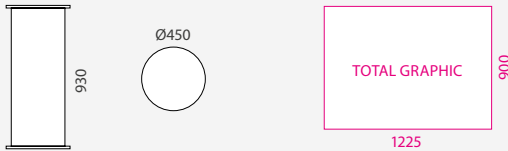

INFORMATION

The Valdes Counter features a circular design that allows the integration of the counter in any space for exhibition and with the advantage of being more accessible than other counters. It has a black wooden countertop and base. It is fast and easy to setup in seconds. A carrying bag with handles is included.

VALDES	QTY	N.W	G.W	C.B.M	SIZE
Packing	2	3.8kg	4.3kg	0.016	460x80x460mm
		2.7kg	3.2kg	0.037	200x200x930mm
10.685		Graphic Size: 1225x900mm			

VALDES



COUNTER DETAILS



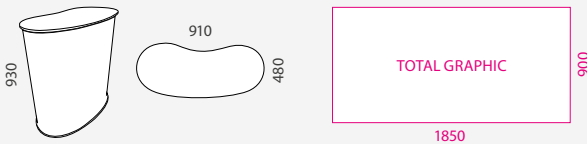

EXTERNAL SIZE

ARTWORK *mm



INFORMATION

The Doiras Counter features a black wooden countertop and base. Also, it has 1 plastic shelf in the interior for storing. A nylon carrying bag with handles is included. Doiras Counter is easy to set-up and breakdown in only a few seconds, making it perfect for travelling business people.

DOIRAS	QTY	N.W	G.W	C.B.M	SIZE
Packing	2	12kg	13kg	0.0372	500x80x930mm
		1.5kg	2kg	0.0372	200x200x930mm
13.475		Graphic Size: 1850x900mm			
13.476					

DOIRAS



* VELCRO® is a registered trademark of Velcro BVBA. | VELCRO® est une marque déposée de Velcro Industries B.V. | VELCRO® é uma marca registrada de Velcro Industries B.V. | VELCRO® es una marca registrada de Velcro Industries B.V.

COUNTER DETAILS

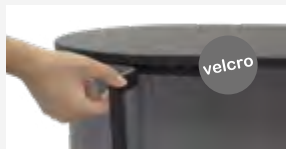

DIMENSIONS

ARTWORK

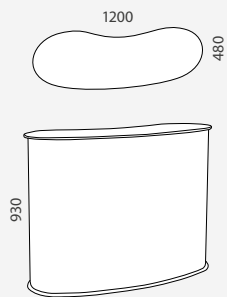

*mm



TOTAL GRAPHIC

INFORMATION

Doiras XL comes with carry bag and exhibitors can quickly assemble it in a few minutes (no tools required) thanks to its genuine VELCRO® brand fasteners system. Once it has been assembled, the counter is lightweight enough to be moved with ease by one person. It has 1 shelf in the interior, so the extra brochures, business cards and flyers can be stored out of sight so your exhibition always appears clean and organized. This counter features wood or black finish available. Ideal for tradeshow and promotional events at stores or business presentations.

DOIRAS XL	QTY	N.W	G.W	C.B.M	SIZE
Packing	1	15kg	16kg	0.2126	450x1050x450mm
13.846-1		Graphic Size: 2150x900mm			
13.846-2		Graphic Size: 2150x900mm			

DOIRAS XL



* VELCRO® is a registered trademark of Velcro BVBA. | VELCRO® est une marque déposée de Velcro Industries B.V. | VELCRO® é uma marca registrada de Velcro Industries B.V. | VELCRO® es una marca registrada de Velcro Industries B.V.

PROMOTION COUNTERS Magnetic Counter

COUNTER DETAILS



DIMENSIONS

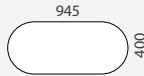

ARTWORK *mm

TOTAL GRAPHIC

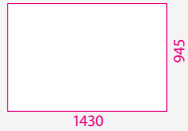

INFORMATION

The Gante counter is available in 3 wooden finishes for the top, moreover is completely portable and functional. This counter comes with 1 interior shelf and 1 carrying case. Graphics are easy to attach thanks its magnetic system.

GANTE	QTY	N.W	G.W	C.B.M	SIZE
Packing	2	9.4kg 0.9kg	10.45kg 1.2kg	0.0786 0.0121	950x460x180mm 1010x105x115mm
13.863-1		Graphic Size: 1430x945mm			
13.863-2					
13.863-3					

GANTE

NEW



COUNTER DETAILS



DIMENSIONS

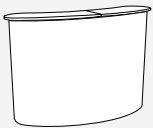

ARTWORK *mm

TOTAL GRAPHIC



INFORMATION

The Cebberos counter is available in 3 wooden finishes for the top, moreover is completely portable and functional. This counter comes with 1 interior shelf and 2 carrying cases. Graphics are easy to attach thanks its magnetic system.

CEBREROS	QTY	N.W	G.W	C.B.M	SIZE
Bottom	1	7.55kg	9.55kg	0.06	380x160x1030mm
Top	1	6.7kg	8.35kg	0.04	460x110x750mm
10.042		Graphic Size: 2035x935mm			
10.392					
10.241					

CEBREROS



NEW

CEBREROS XL



COUNTER DETAILS

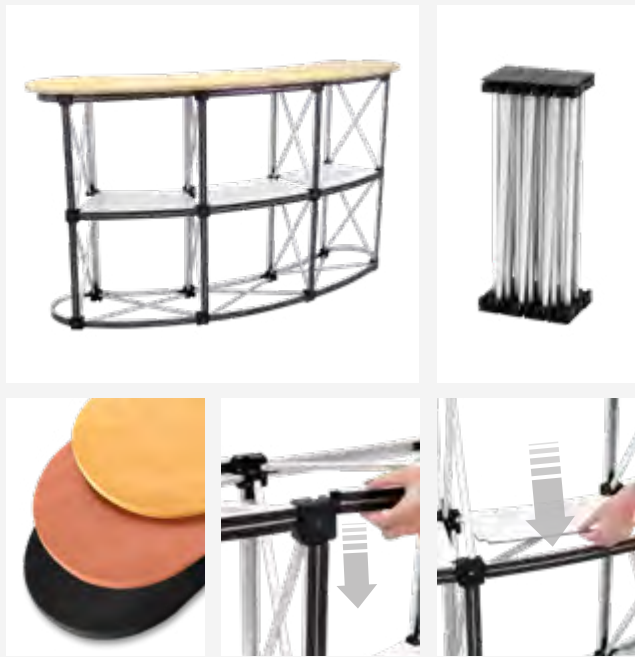

DIMENSIONS

ARTWORK

*mm

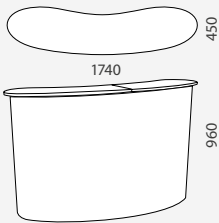



TOTAL GRAPHIC



INFORMATION

With 3 wooden finishes for the top, this stylish Counter is completely portable and functional. With 1 interior shelf and 2 carrying cases. Graphics are easy to attach thanks its magnetic system. Ideal for promotional needs like holding product samples, corporate literature, business cards, brochures and more.

CEBREROS XL 1	QTY	N.W	G.W	C.B.M	SIZE
Packing	3	7.8kg	8.5kg	0.0419	545x285x270mm
		10.15kg	10.85kg	0.0324	950x75x455mm
		1.4kg	1.85kg	0.025	1010x160x155mm
13.864-1		Graphic Size: 2460x935mm			

CEBREROS XL 2	QTY	N.W	G.W	C.B.M	SIZE
Packing	3	7.8kg	8.5kg	0.0419	545x285x270mm
		10.15kg	10.85kg	0.0324	950x75x455mm
		1.4kg	1.85kg	0.025	1010x160x155mm
13.864-2		Graphic Size: 2460x935mm			

CEBREROS XL 3	QTY	N.W	G.W	C.B.M	SIZE
Packing	3	7.8kg	8.5kg	0.0419	545x285x270mm
		10.15kg	10.85kg	0.0324	950x75x455mm
		1.4kg	1.85kg	0.025	1010x160x155mm
13.864-3		Graphic Size: 2460x935mm			





COUNTER DETAILS



*Printed on fabric.
Impression sur toile.
Impressão em tecido.
Impresión en tela.



BARACOA



EXTERNAL SIZE

ARTWORK

*mm

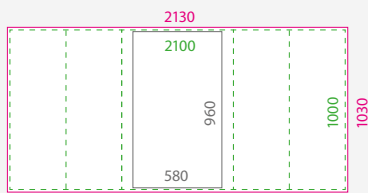
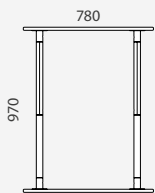

FRONT VIEW
SAFE ZONE
TOTAL GRAPHIC

INFORMATION

These Counters are designed for using with fabric wrap (printed on textile) making it lightweight and easy to fold. Also, the Fabric Counters are also simple to setup. All the aluminium poles fit together and snap into place. Simply stretch the wrap over the completed base and it's ready to use. With carry bag for easy travelling. Features a double zip to the interior of the counter for storing, so your exhibition always appears clean and organized. Baracoa is ideal as a lectern or podium at tradeshow, promotional events or conventions and are great to pair with Pop Up banners or any stand.

BARACOA	QTY	N.W	G.W	C.B.M	SIZE
Packing	1	8kg	9.2kg	0.042	860x120x410mm
13.740	Graphic Size: 2130x1030mm				





COUNTER DETAILS



*Printed on fabric.
Impression sur toile.
Impressão em tecido.
Impresión en tela.

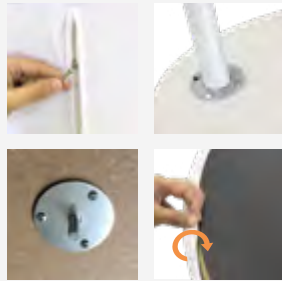

EXTERNAL SIZE

ARTWORK

*mm

DOWNLOAD

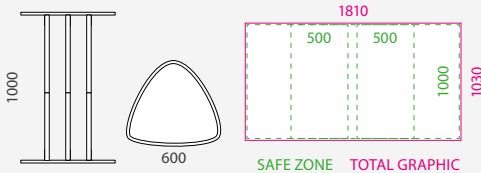

INFORMATION

Creta is lightweight and easy to fold and setup. With carry bag and a single zip to the interior for storing. Features 3 points of view. Ideal as a lectern or podium at tradeshows, events or conventions.

CRETA	QTY	N.W	G.W	C.B.M	SIZE
Packing	1	11kg	12kg	0.04	650x100x650mm
10.311	Graphic Size: 1810x1030mm				

CRETA



COUNTER DETAILS



*Printed on fabric.
Impression sur toile.
Impressão em tecido.
Impresión en tela.

automatic hydraulic



EXTERNAL SIZE

ARTWORK

*mm

DOWNLOAD

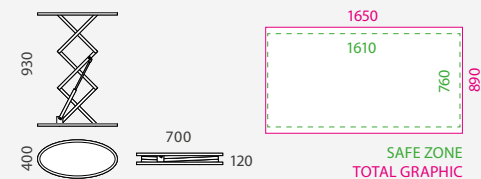

INFORMATION

Siena is lightweight and easy to fold and setup. With a hard carry padded bag and a double zip. Features an **hydraulic drive system** for an automatic and quick unfolding with just a slight push on the top of the counter. Ideal for events or conventions and are great to pair with Pop Up banners or any stand.

SIENA	QTY	N.W	G.W	C.B.M	SIZE
Packing	1	5.6kg	7.6kg	0.21	970x600x360mm
15.244	Graphic Size: 1650x890mm				

SIENA

AUTO UNFOLD



* Printing is available but not included



COUNTER DETAILS



*Printed on fabric.
Impression sur toile.
Impressão em tecido.
Impresión en tela.

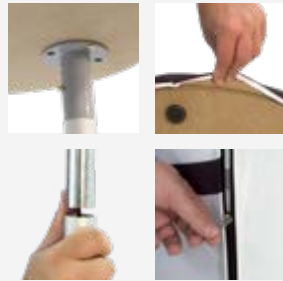

EXTERNAL SIZE

ARTWORK

*mm

DOWNLOAD

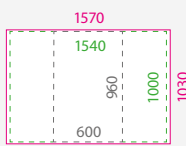
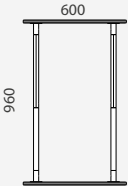

FRONT VIEW SAFE ZONE TOTAL GRAPHIC

INFORMATION

Manacor is lightweight and fast to setup. Features an oval shape design. With carry bag and a double zip to the interior for storing. Ideal as a lectern or podium at tradeshows, events or conventions.

MANACOR	QTY	N.W	G.W	C.B.M	SIZE
Packing	1	7.0kg	7.44kg	0.0366	440x130x640mm
10.318	Graphic Size: 1570x1030mm				

MANACOR



COUNTER DETAILS



*Printed on fabric.
Impression sur toile.
Impressão em tecido.
Impresión en tela.



EXTERNAL SIZE

ARTWORK

*mm

DOWNLOAD

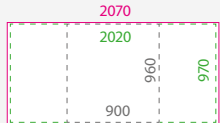
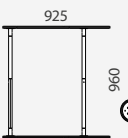

FRONT VIEW SAFE ZONE TOTAL GRAPHIC

INFORMATION

Mahon is lightweight and easy to assembly. Features the classic raindrop shape design. With carry bag and a double zip to the interior for storing. Ideal as a lectern or podium at promotional events, tradeshows, point of sales.

MAHON	QTY	N.W	G.W	C.B.M	SIZE
Packing	1	10.50kg	10.93kg	0.0672	500x140x960mm
10.319	Graphic Size: 2070x1000mm				

MAHON



* Printing is available but not included

CATANIA

CONTENT

EN

Portable Display Wall. The construction makes an easy and fast assembly.
 • Aluminium Profile, base feet and two spotlights.
 • Oxford Cloth bag: 1 unit.

FR

Display portable, facile et rapide à monter.
 • Profils en aluminium, bases et foyers d'éclairage.
 • Valise de transport Oxford Cloth: 1 unité.

PT

Display portátil de fácil e rápida montagem.
 • Perfis de alumínio, bases e focos.
 • Mala de transporte Oxford Cloth: 1 unidade.

ES

Display portátil de fácil y rápido montaje.
 • Perfil de aluminio, bases y dos focos.
 • Bolsa de transporte: 1 unidad.



spotlights included



1 oxford bag included



WALL DETAILS



INFORMATION

This portable exhibition display unit features a lightweight, yet sturdy, aluminium profile structure. This unit can be easily assembled fast and easily. The entire portable display can be set up and taken down within minutes. It's composed by 1 aluminium frame structure, 2 round bases and 1 oxford bag for an easy transportation. Also 2 spotlights are included. Pair this backdrop wall with some trade show fixtures available on this catalogue, such as counters, iPad mounts, chairs or brochure stands. The exhibition booths, offer a great way to market your business at trade shows, conventions, media events or expos.

EXTERNAL SIZE

*mm

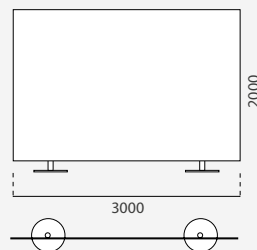

CATANIA	QTY	N.W	G.W	C.B.M	SIZE
Packing	1	15kg	16.2kg	0.14	420x150x1250mm
10.647		Size: 3000x2000mm			

* Printing is available but not included.

PERUGIA

CONTENT

EN

Portable Display Wall. The construction makes an easy and fast assembly.
 • Aluminium Profile, base feet and two spotlights.
 • Oxford Cloth bag: 1 unit.

FR

Visuel portable, facile et rapide à monter.
 • Profils en aluminium, bases et foyers d'éclairage.
 • Valise de transport Oxford Cloth: 1 unité.

PT

Display portátil de fácil e rápida montagem.
 • Perfis de alumínio, bases e focos.
 • Mala de transporte Oxford Cloth: 1 unidade.

ES

Display portátil de fácil y rápido montaje.
 • Perfil de aluminio, bases y dos focos.
 • Bolsa de transporte: 1 unidad.



2 spotlights included



Oxford bag included

INFORMATION

This portable exhibition display unit features a lightweight, yet sturdy, 2x3m aluminium profile structure. This unit can be easily assembled fast and easily. The entire portable display can be set up and taken down within minutes. It's composed by 1 aluminium frame structure, 2 round bases and 1 oxford bag for an easy transportation. Also 2 spotlights are included. Pair this backdrop wall with some trade show fixtures available on this catalogue, such as counters, iPad mounts, chairs or brochure stands. The exhibition booths, offer a great way to market your business at trade shows, conventions, media events or expos.

PERUGIA	QTY	N.W	G.W	C.B.M	SIZE
Packing	1	15kg	16.2kg	0.14	420x150x1250mm
10.648	Graphic Size: 3000x2000mm				

EXTERNAL SIZE

ARTWORK

*mm

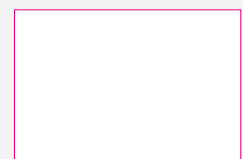
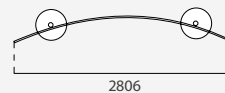

3000

TOTAL GRAPHIC

* Printing is available but not included.

QUICK SYSTEM

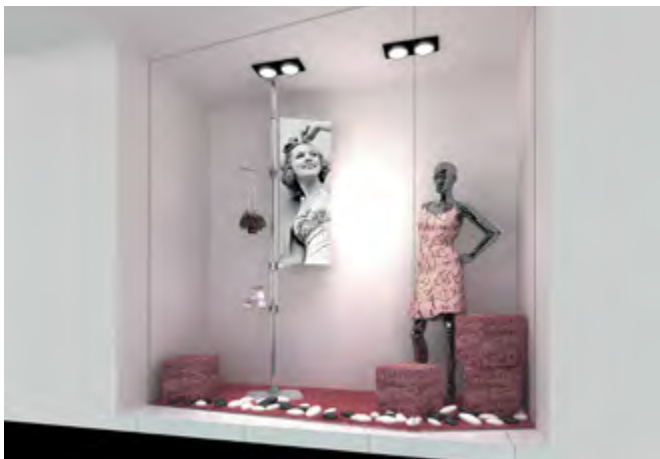

TELESCOPIC POLE

aluminium pole system



1200 POLE	*mm	1500 POLE	*mm	2000 POLE	*mm
POLE 1		POLE 2		POLE 3	
10.961	Ø45x1200mm	10.962	Ø45x1500mm	10.963	Ø45x2000mm

7 WAYS CONNECTOR

CONNECTOR *mm

Ø40 / 45

49

7 WAYS CONNECTOR

10.968-40	Ø40mm
10.968-45	Ø45mm

ALU BLOCK

ALU BLOCK *mm

34

16

9

ALU BLOCK

10.969	x10
--------	-----

RAIL

INFORMATION *mm

- Combine it with:
- + pvc insert
- + end caps
- + connecting plate
- + side connecting block
- + back connecting block

18

9

35

6

RAIL

10.970	Length: 2 meters
--------	------------------

POLE'S END CAPS

CAP

END CAPS

10.966	x10
--------	-----

BASE CONNECTOR

*mm

100

100

BASE CONN.

10.967	
--------	--

screw to the base

SQUARE BASE

SQUARE BASE *mm

380

380

SQUARE B.

10.964	380x380
--------	---------

FEET BASE

FEET BASE *mm

275

355

380

FEET BASE

10.965	
--------	--

PVC INSERT

INFO *mm

- Stick it to the PVC
Adhesive



PVC INSERT

10.862

Length: 2 meter

SIDE CONNECTING BLOCK

BLOCK *mm

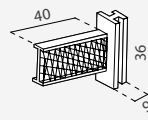

SIDE C.B.

10.863

x10 

BACK CONNECTING BLOCK

INFO *mm

- Rail connection.

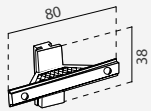

BACK C.B.

10.864

x10 

END CAP

INFO *mm

- Connect it to a rail.
- Grey color finished.

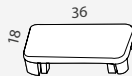

END CAP

10.971

x10 

GRAPHIC CLIP

CLIP *mm



G.CLIP

10.539

Ø45mm

x10 

10.540

Ø40mm

x10 

WIRE CLIP

INFO *mm

- Wires holder.



WIRE CLIP

10.541

Ø45mm

x10 

10.542

Ø40mm

x10 

INFO *mm

- 19mm width.
- Front connection.

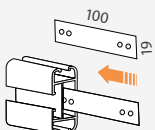

C.PLATE 19

10.972

x10 

100x19mm 

CONNECTING PLATE

INFO *mm

- 12mm width.
- Sideway connection.

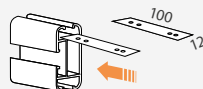

C.PLATE 12

10.973

x10 

100x12mm 

PLASTIC CLIP

INFO

- Plastic.
- Ideal for holding poster or banner.



PLASTIC CLIP

10.537

x10 

SIDE CLIP

INFO

- Plastic.



SIDE CLIP

10.538

x10 

ARC SHELF

INFO

- Includes 2 Alu Block.

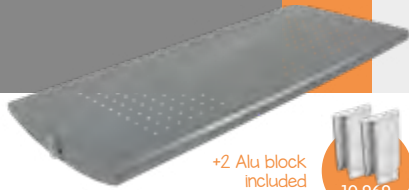

+2 Alu block included



10.969

10.959

828x350mm

SHELF

INFO

- Includes 4 Alu Block.

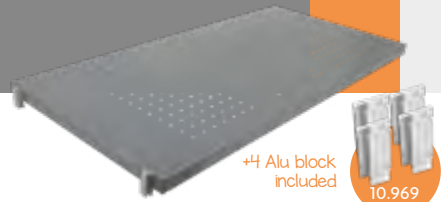

+4 Alu block included



10.969

10.960

825x400mm

LCD BRACKET

INFO

- Plastic.
- Includes 1 Alu Block.

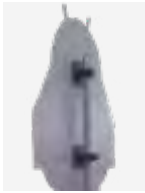

+1 Alu block included



10.969

10.543



PANEL

INFO

- Metallic.
- Perforated.
- Includes 4 Alu Block.



+4 Alu block included



10.969

10.958

825x1000mm

all brochures holders include Alu Block



10.969

INFO

- Includes 1 Alu Block.
- For A4 size documents.



INFO

- Includes 1 Alu Block.
- For A5 size documents.



BROCH. A5

10.545

A5

ACRILYC BROCHURE HOLDER

INFO

- Includes 1 Alu Block.
- For A6 size documents.



BROCH. A6

10.546

A6

INFO

- With connecting base. Ideal for illuminating your exhibit booth and shed light on your products.

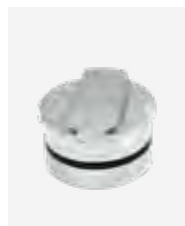

SPOTLIGHT



SPOTLIGHT

10.389

475x138mm

TRUSS DETAILS



light weight
and high
strength



STANDARD SIZES

*mm

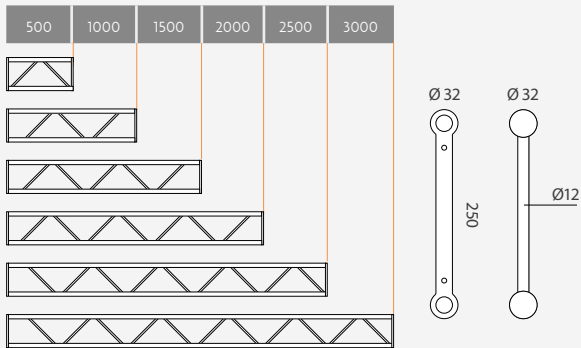

INFORMATION

Aluminium Truss "Duo" formed by 2 aluminum bars, color "natural silver."

TRUSS DUO	SIZE
15.305	500mm
15.060	1000mm
15.063	1500mm
15.066	2000mm
15.306	2500mm
15.307	3000mm

ALUMINIUM
TRUSS "DUO"







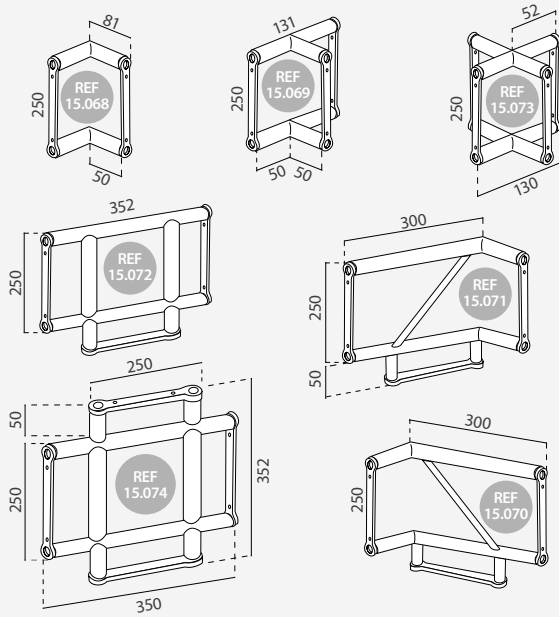

STANDARD SIZES

*mm



STANDARD SIZES

CONNECTOR	SIZE	
15.068	2 connection sides	
15.069	3 connection sides	
15.070	3 connection sides	
15.071	3 connection sides	
15.072	3 connection sides	
15.073	4 connection sides	
15.074	4 connection sides	

ALUMINIUM TRUSS "DUO" CONNECTOR

TRUSS DETAILS



light weight
and highly
resistant



INSTALL EXPLANATION

*mm

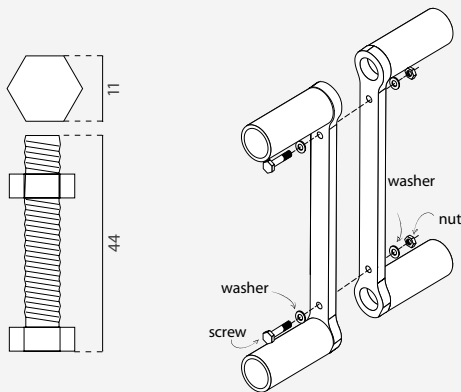

INFORMATION

These screws for mounting the aluminum Truss are made of steel. Nut is supplied.

S CREWS T.	SIZE
15.040	44x11mm

STEEL SCREWS FOR ALUMINIUM TRUSS





INFORMATION

EN	Vertical aluminium Truss, 32 mm diameter. Ideal for producing and assembling a booth, venues, outdoor events, placing graphics, etc. It is characterized by its great resistance, lightweight and easy assembly. Color: natural silver.
FR	Colonne de Truss fabriquée en aluminium, couleur "argent naturel" avec tubes de 32mm de diamètre. Idéal pour la réalisation et le montage de stands, scènes, événements extérieurs, suspension de bâches, etc. Léger, résistant et facile à monter.
PT	Colunas Truss fabricadas em alumínio, em cor prateada, com tubos de 32mm de diâmetro. Ideal para a realização e montagem de stands, cenários, eventos ao ar livre, colocação de lonas, entre outros. Caracteriza-se pela sua grande resistência, leveza e fácil montagem.
ES	Largueros Truss, fabricados en aluminio, color "plata natural", con tubos de 32mm de diámetro. Ideal para realización y montaje de stands, escenarios, eventos al aire libre, colocación de lonas, etc. De gran resistencia, peso ligero y fácil montaje.

ALUMINIUM TRUSS "SHOW"

light weight and resistant



with accessories

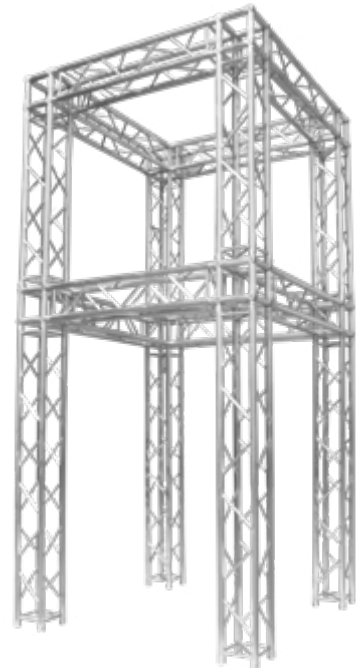

"SHOW"		SIZE	500	750	1000	1500	2000	2500	3000
15.301	500x250mm								
15.302	750x250mm								
15.141	1000x250mm								
15.143	1500x250mm								
15.145	2000x250mm								
15.303	2500x250mm								
15.304	3000x250mm								

MAIN TUBES	Ø32x1.2mm
BRACES	Ø12x1.0mm
MATERIAL	Alloy En-Aw 6005 T6
WEIGHT	1.84 kg/m

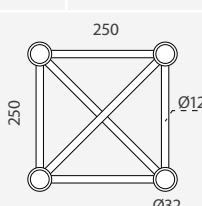

INFORMATION

EN	Connectors for joining Truss spars. Produced in aluminum and with "natural silver" finish.
FR	Cube pour l'union de colonnes de Truss. Fabriqué en aluminium est de couleur "argent naturel".
PT	Cubos de união para colunas Truss fabricados em alumínio de cor prateada.
ES	Cubos para unión de largueros de Truss. Fabricados en aluminio con acabado "plata natural".

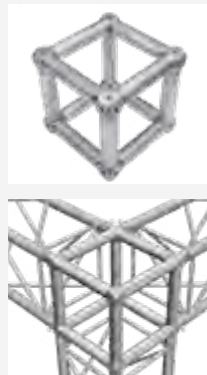

CONNECTOR T.	SIZE
15.147	250x250x250mm

CONNECTOR TRUSS



CONICAL CONNECTOR

INFO

Conical connector for joining Truss bars.

15.148



HALF CONICAL CONNECTOR

INFO

Conical semiconnector for joining Truss bars + bolt.

15.151



PIN

INFO

Pin for the connection of Truss bars

15.149

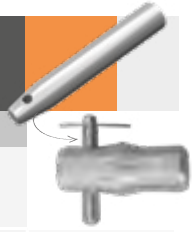

INFORMATION

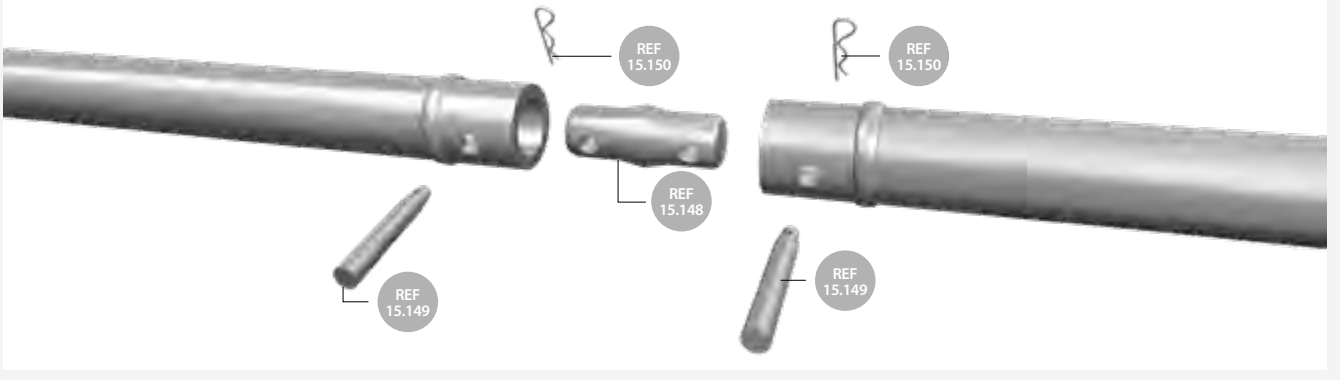

SAFETY CLIP

INFO

Clip to secure the connection of Truss bars

15.150



BASE FOR ALUMINIUM TRUSS "SHOW"

INFO

Steel base for aluminium Truss "Show".

15.300

300x300mm

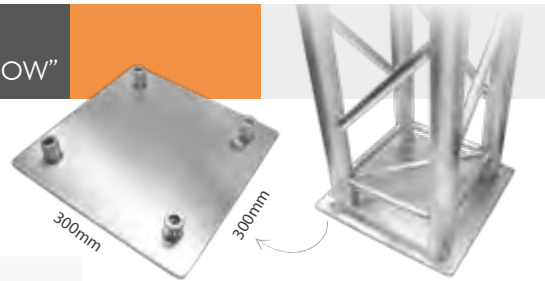

INSTALL EXPLANATION

x4



x8



x8

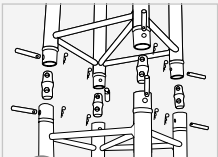

1

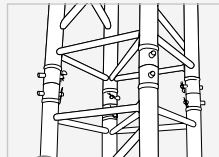

2

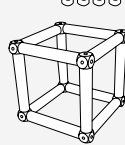

1

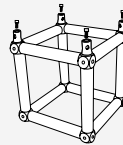

2

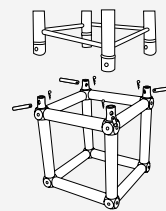

3

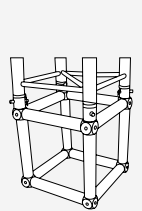

4



EMMS CHAIR



CHAIR DETAILS



INFORMATION

*mm

The Emms Chair features a 830mm height with a one-piece back-seat made of plastic and wooden legs. Timeless style. Black or white finish available.

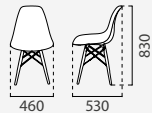

	QTY	N.W	G.W	C.B.M	SIZE
Packing	4	16.7kg	18.5kg	0.15	580x520x530mm
39.005WH	<input type="checkbox"/>	460x830x530mm			
39.005BK	<input type="checkbox"/>				

FEGEN TABLE Ø1m



TABLE DETAILS



INFORMATION

*mm

The 730mm high Fegen Table features a white finish Ø1000mm MDF table top and classic wooden legs with leveling height. Its neutral and natural colors are a timeless combination and they make it fit perfectly with any decorative trend, so it is a very requested option.

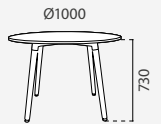

	QTY	N.W	G.W	C.B.M	SIZE
Packing	1	18kg	22kg	0.11	1080x1080x210mm
32.141WH	<input type="checkbox"/>	730xØ1000mm			

EMMS STOOL



STOOL DETAILS



INFORMATION

*mm

The Emms Stool features a 1090mm height with a one-piece back-seat made of plastic and wooden legs. Modern and classic at the same time. 2 finish available

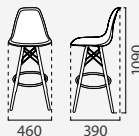

	QTY	N.W	G.W	C.B.M	SIZE
Packing	2	11.70kg	13.70kg	0.32	590x590x900mm
39.009WH	<input type="checkbox"/>	460x390x1090mm			
39.010	<input type="checkbox"/>				

HEIDAL HIGH TABLE



TABLE DETAILS



INFORMATION

*mm

The 1008mm high Heidal Table features a white finish Ø600mm MDF table top and wooden legs with leveling height. A modern and classic style at the same time.

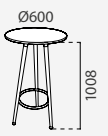

	QTY	N.W	G.W	C.B.M	SIZE
Top Packing	1	6.6kg	9kg	1.60	680x680x150mm
Legs Packing	1	150x600x1050mm			
32.142WH	<input type="checkbox"/>	Total Size: 1008xØ600mm			
Top Wood: 20mm thickness					

OLIIX CHAIR



CHAIR DETAILS



INFORMATION

*mm

The Oliix Chair is inspired by the Tolix Mate Chair by designer Xavier Pauchard. Featuring a 850mm height with a back and seat made of reinforced steel. Modern and classic at the same time. White and black available.



	QTY	N.W	G.W	C.B.M	SIZE
Packing	4	18.8kg	21kg	0.19	490x460x840mm
39.112-101	<input type="checkbox"/>	450x850x540mm			
39.112-102	<input type="checkbox"/>				

STANDART TABLE



TABLE DETAILS



INFORMATION

*mm

The Standart Table is inspired by the design of the EM Table, created by designer and engineer Jean Prouvé in the 1950s. Featuring a 710mm height and a Ø800mm Table Wooden Top with steel blackened legs. A modern and classic style at the same time.

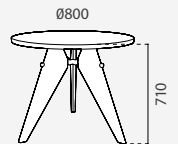

	QTY	N.W	G.W	C.B.M	SIZE
Packing	1	16.6kg	17.5kg	0.093	120x880x880mm
32.200BK	<input type="checkbox"/>	Ø800x710mm			

OLIIX STOOL



STOOL DETAILS

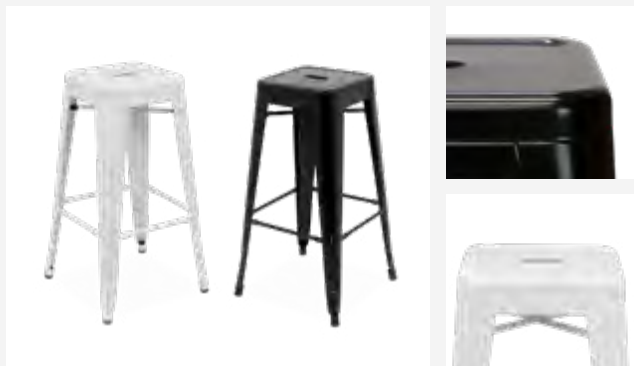

INFORMATION

*mm

Industrial style High Kitchen Stool inspired by Tolix Stool by designer Xavier Pauchard. It is one-piece made of reinforced steel with a Timeless style design. With footrest and black or white finish available.

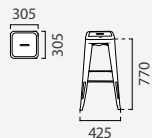

	QTY	N.W	G.W	C.B.M	SIZE
Packing	4	18.4kg	21kg	0.23	445x445x1160mm
39.119-101	<input type="checkbox"/>	425x425x770mm			
39.119-102	<input type="checkbox"/>				

OLIIX HIGH TABLE



TABLE DETAILS

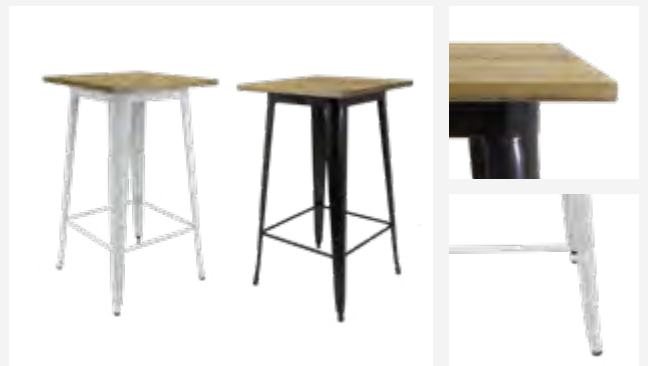

INFORMATION

*mm

The Oliix industrial high table, with wooden surface. Inspired by Xavier Pauchard's Tolix series. 1050mm height and one-piece made of reinforced steel and wooden table top. With footrest. Black or white finish available.

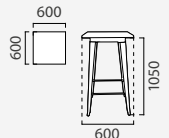

	QTY	N.W	G.W	C.B.M	SIZE
Packing	1	17kg	19.5kg	0.08	1000x620x130mm
39121-1WH	<input type="checkbox"/>	Total Size: 600x1050x600mm			
39121-1BK	<input type="checkbox"/>	Top Wood: 25mm thickness			

TULIP CHAIR

new



CHAIR DETAILS



INFORMATION

*mm

The nordic chair Tulip in one-piece back-seat of polypropylene, with cushion and legs in beech. Inspired by the design of the Finnish architect and designer, Eero Saarinen. 830mm height. Black or white finish.

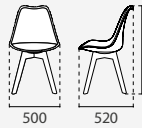

	QTY	N.W	G.W	C.B.M	SIZE
Packing	4	18.8kg	21kg	0.211	580x490x740mm
32.207WH	<input type="checkbox"/>	500x830x520mm			
32.207BK	<input type="checkbox"/>				

TULIP STOOL

new



STOOL DETAILS



INFORMATION

*mm

The Tulip Stool features an adjustable height up to 1040mm. Its seat with backrest is made of polypropylene and leatherette cushion, so it provides a greater comfort. With chromed base and black or white finish available.



	QTY	N.W	G.W	C.B.M	SIZE
Packing	2	12kg	14kg	0.023	520x350x430mm
39.022	<input type="checkbox"/>	Ø400x820-1040mm			
39.021	<input type="checkbox"/>				

CAMIN STOOL



STOOL DETAILS



INFORMATION

*mm

The Camin Bar Stool features an adjustable height up to 850mm and it is made of Polypropylene comfortable plastic with a chromed finished structure. Also, with footrest. White and black color available.



	QTY	N.W	G.W	C.B.M	SIZE
Packing	1	10.7kg	11.07kg	0.052	460x300x420mm
31.284WH	<input type="checkbox"/>	Ø380x640-850mm			
31.284BK	<input type="checkbox"/>				

RUBENS TABLE



TABLE DETAILS



INFORMATION

*mm

With a timeless style, the Rubens Bar High Table features a Ø600mm top surface made of ABS plastic with a stable chromed finished structure. Also, there are white or black finish counter-top available.

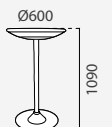

	QTY	N.W	G.W	C.B.M	SIZE
Packing	1	7.3kg	8.1kg	0.108	620x200x620mm 180x180x990mm
31.037	<input type="checkbox"/>	Ø600x1090mm			
31.038	<input type="checkbox"/>				

FLOOR SYSTEM DETAILS

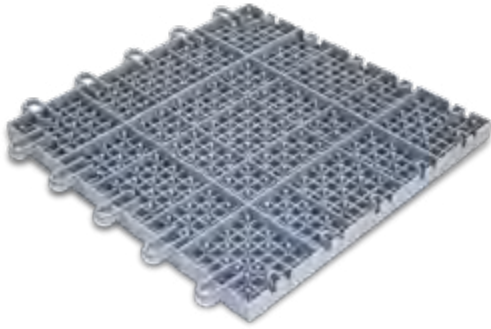

DIMENSIONS

*mm

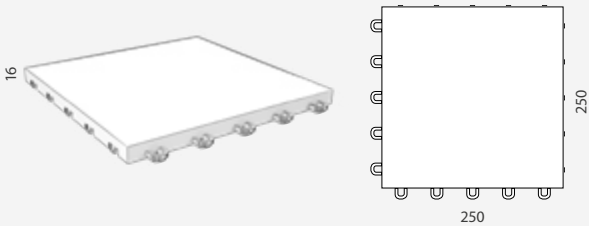

INFORMATION

Snap together these plastic interlocking floor tiles for an easy install and quick setup. Flooring made of high impact material results in long term use and dependability. Beneath each of the floor tiles there are ribbed support pillars for impact and shock absorption. Whether the 250x250mm configuration is used in a trade show booth exhibit, these multi-purpose floor tiles are suitable for indoor or outdoor events. Each unit with the reinforced composition provides a strong foundation efficient for impact and shock absorption. Ideal for a trade show booth set up. 5 colors available.

15.209



x16  (1m²)

TILE FOR FLOOR SYSTEM



FLOOR SYTEM DETAILS

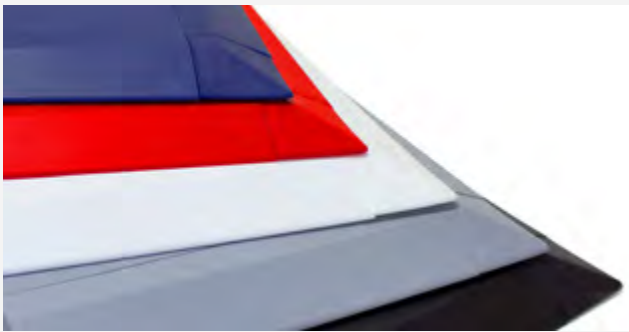
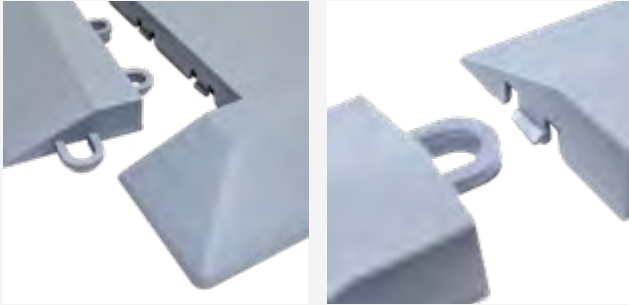

FLOOR SYTEM DETAILS







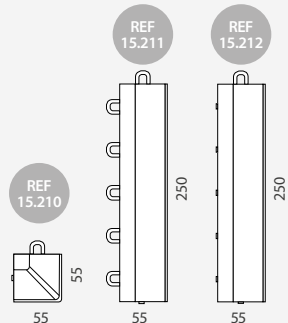

INFORMATION

DIMENSIONS

*mm

Flooring construction is made easy with the clip and loop plastic tiles which allow each component to snap together without any tool. Create a finished and clean look by adding the sloped edge and mitered corner attachments to the perimeter for a smooth transition into a trade show booth. Each unit with the reinforced composition provides a strong foundation efficient for impact and shock absorption. Ideal for a trade show booth set up. 5 colors available.



15.210		Corner x4 
15.211		Frame Male x8 
15.212		Frame Female x8 

FRAME FOR FLOOR SYSTEM

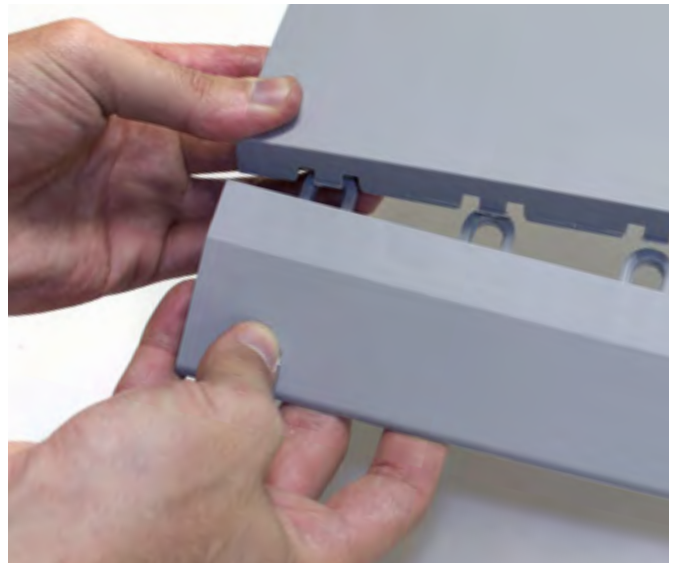

YUSTE

4.5m

FLAG DETAIL



ARTWORK

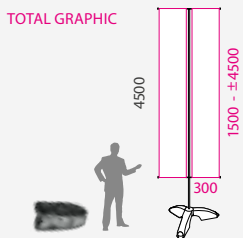

INFORMATION

Yuste is a telescopic flagpole with a refillable 6l base. It can be used with 2 flag banners (1-sided or 2-sided option). It is made of aluminium and plastic. Carry bag is included.



YUSTE	QTY	N.W	G.W	C.B.M	SIZE
Pole	1	1.35kg	1.85kg	0.015	120x80x1650mm
Base	1	0.95kg	1.15kg	0.017	260x200x340mm
10.709	Graphic Size: ± 300x1500-4500mm (x2)				

BREST

4.1m

FLAG DETAIL

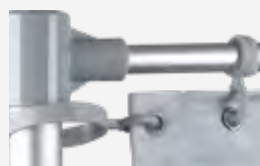
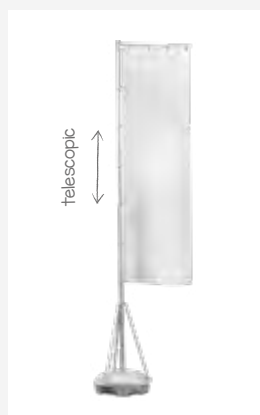

ARTWORK

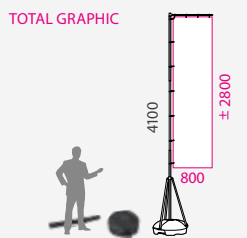

INFORMATION

Brest is a telescopic flagpole with a refillable 50l base. Its feet structure is foldable for an improved storing. It is made of aluminium and plastic. Carry bag is included.



BREST	QTY	N.W	G.W	C.B.M	SIZE
Pole	1	4.1kg	5.1kg	0.029	135x135x1610mm
Base	1	6kg	6.3kg	0.117	665x265x665mm
10.652	Graphic Size: ± 800x2800mm				

* Printing is available but not included.

FLAG DETAILS

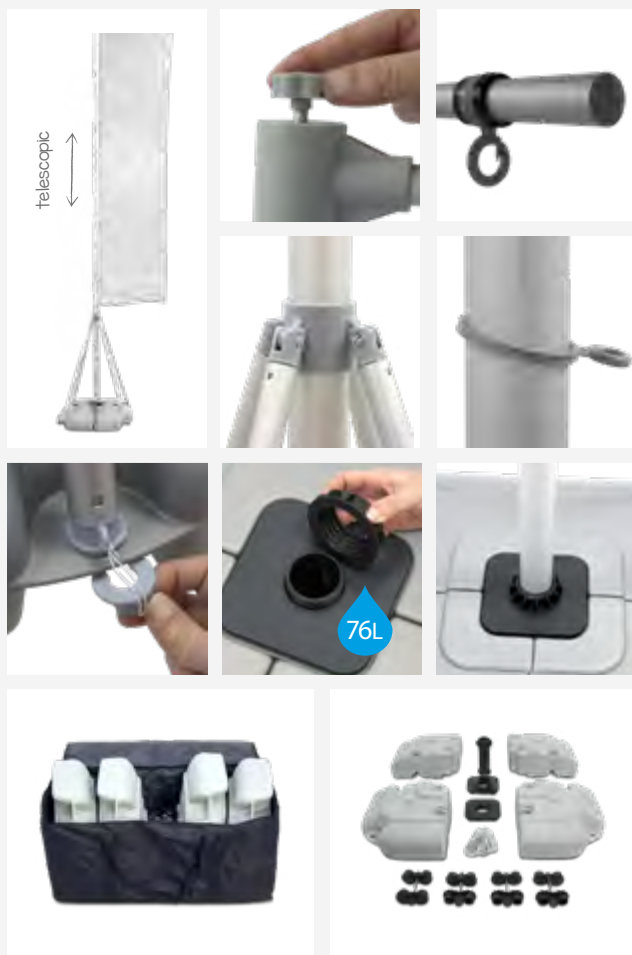

DIMENSIONS

ARTWORK

*mm

TOTAL GRAPHIC

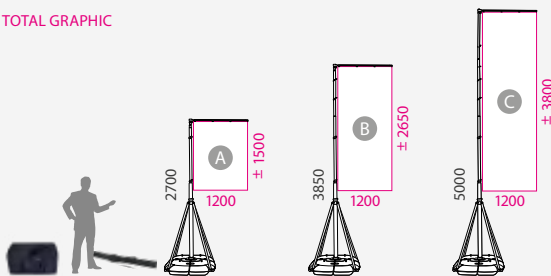

INFORMATION

The Bejar is a telescopic flagpole adjustable to 3 heights: 2700, 3850 or 5000mm with a refillable 76l plastic base. Its feet structure is foldable and its base is 4-pieces removable for an improved storing. Bejar flagpole is made of aluminium and plastic parts. 2 carry nylon bags are included for a better transportation. Ideal for being used at outdoor events, tradeshows, exposition entrances or just for displaying to large distances.

BEJAR	QTY	N.W	G.W	C.B.M	SIZE
Pole	1	7.5kg	9.8kg	0.04	160x130x1680mm
Base	1	10kg	11kg	0.14	430x380x850mm
10.031	Graphic Size: 1200x A B C mm				

BEJAR

5m



* Printing is available but not included.

FLAG DETAILS



DIMENSIONS

ARTWORK

*mm

TOTAL GRAPHIC

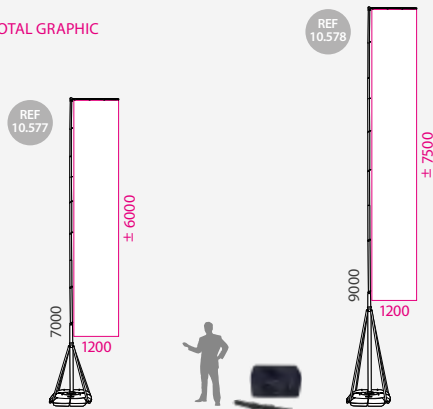

INFORMATION

The Cergy is a telescopic flagpole with a refillable 60 l plastic base. Its feet structure is foldable and its base is 4-pieces removable for an improved storing. Cergy flagpole is made of aluminium and plastic parts. A carry nylon bag is included for a better transportation. With the biggest heights available, they are ideal for being used at outdoor events, tradeshows exposition entrances.

CERGY 6000	QTY	N.W	G.W	C.B.M	SIZE
Pole	1	6.5kg	7.5kg	0.04	2200x140x140mm
Base	1	8kg	9kg	0.12	800x360x410mm
10.577	Graphic Size: ± 1200x6000mm				

CERGY 7500	QTY	N.W	G.W	C.B.M	SIZE
Pole	1	8.5kg	9.5kg	0.04	2220x140x140mm
Base	1	8kg	9kg	0.12	800x360x410mm
10.578	Graphic Size: ± 1200x7500mm				

CERGY

9-7m



* Printing is available but not included.

NEW

FLAG DETAILS



ARTWORK

*mm

SAFE ZONE
TOTAL GRAPHIC

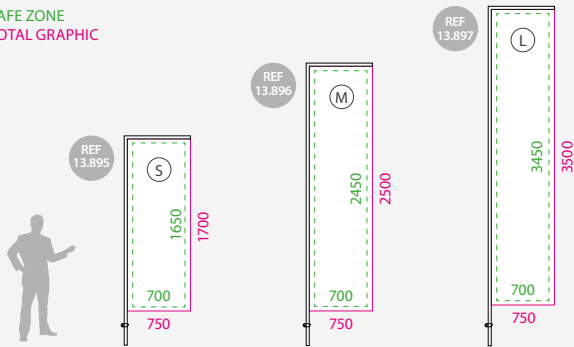

INFORMATION

AVAILABLE ACCESSORIES

Square flagpole is usually used for promoting on beaches. Its lightweight pole set-up and down in seconds for an improved storage. Carry bag included. Several accessories are available later at this chapter. Textile manufacturing is available (not included). You can choose **A** white or **B** black colour of pole sheath.

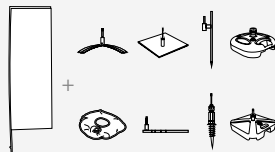

SQUARE S	QTY	N.W	G.W	C.B.M	SIZE
Packing	35	15.70kg	16.30kg	0.06	1200x250x180mm
13.895	(S)	Graphic Size: 750x1700mm			

SQUARE M	QTY	N.W	G.W	C.B.M	SIZE
Packing	20	14.50kg	15kg	0.06	1420x230x170mm
13.896	(M)	Graphic Size: 750x2500mm			

SQUARE L	QTY	N.W	G.W	C.B.M	SIZE
Packing	20	19kg	19.6kg	0.06	1420x230x170mm
13.897	(L)	Graphic Size: 750x3500mm			

SQUARE ECONOMIC FLAG



* Textile printing, bases and other accessories are available but not included. The price includes only the flagpole.

NEW

FLAG DETAILS



ARTWORK

*mm

SAFE ZONE
TOTAL GRAPHIC

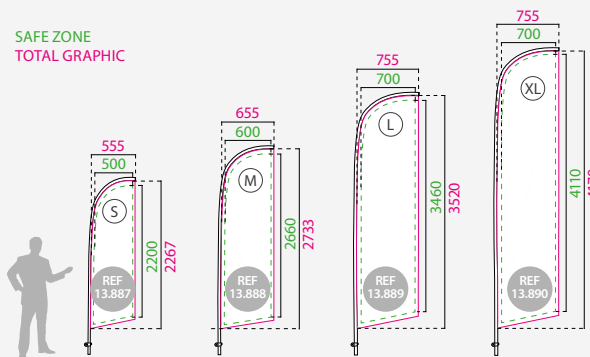

INFORMATION

AVAILABLE ACCESSORIES

The Knife is a flagpole made of fiberglass, aluminium and plastic. The pole is collapsible for an easy portability. Also, a nylon carry bag is included. Multiple accessories are available later at this chapter. Textile manufacturing is available (not included). You can choose **A** white or **B** black colour of pole sheath.



KNIFE S	QTY	N.W	G.W	C.B.M	SIZE
Packing	50	17.10kg	17.60kg	0.05	1040x220x220mm
13.887	(S)	Graphic Size: 555x2267mm			
KNIFE M	QTY	N.W	G.W	C.B.M	SIZE
Packing	45	19.10kg	19.70kg	0.05	1185x250x180mm
13.888	(M)	Graphic Size: 655x2733mm			
KNIFE L	QTY	N.W	G.W	C.B.M	SIZE
Packing	35	21.20kg	21.80kg	0.05	1185x250x180mm
13.889	(L)	Graphic Size: 755x3520mm			
KNIFE XL	QTY	N.W	G.W	C.B.M	SIZE
Packing	20	17kg	17.60kg	0.05	1185x250x180mm
13.890	(XL)	Graphic Size: 755x4170mm			

KNIFE ECONOMIC FLAG



* Textile printing, bases and other accessories are available but not included. The price includes only the flagpole.

new

FLAG DETAILS



ARTWORK

*mm

SAFE ZONE
TOTAL GRAPHIC

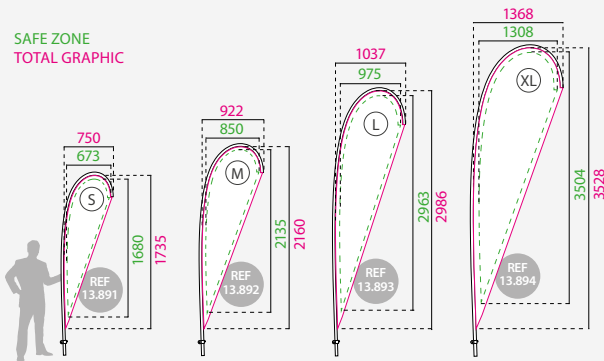

INFORMATION

AVAILABLE ACCESSORIES

The Economic Spoon is a flagpole made of fiberglass, aluminium and plastic. The pole is collapsible for an easy portability. Also, a nylon carry bag is included. Multiple accessories are available later at this chapter. Textile manufacturing available (not included). You can choose **A** white or **B** black colour of pole sheath.

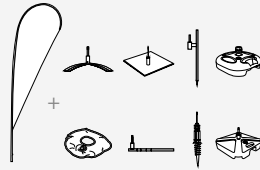

SPOON S	QTY	N.W	G.W	C.B.M	SIZE
Packing	40	14.50kg	15kg	0.04	940x250x150mm
13.891	S	Graphic Size: 750x1735mm			
SPOON M	QTY	N.W	G.W	C.B.M	SIZE
Packing	30	13.30kg	13.80kg	0.04	940x250x150mm
13.892	M	Graphic Size: 922x2160mm			
SPOON L	QTY	N.W	G.W	C.B.M	SIZE
Packing	40	23kg	23.50kg	0.05	1185x250x180mm
13.893	L	Graphic Size: 1037x2986mm			
SPOON XL	QTY	N.W	G.W	C.B.M	SIZE
Packing	25	20.70kg	21.30kg	0.05	1185x250x180mm
13.894	XL	Graphic Size: 1368x3528mm			

SPOON ECONOMIC FLAG

BUY AND SAVE
ECONOMIC
BEST DEAL



* Textile printing, bases and other accessories are available but not included. The price includes only the flagpole.

GROUND PLASTIC DRILL

new

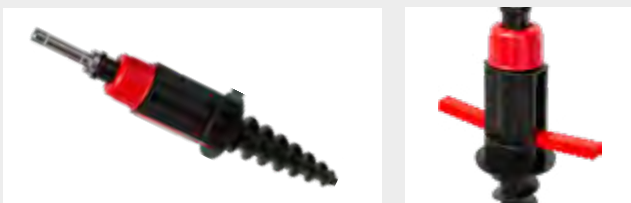

INFORMATION

*mm

Very fast to use on soft grounds like sand or snow. Made of plastic and iron. Ideal for displaying at the beach or ski slopes in winter.

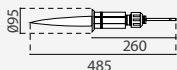

	QTY	N.W	G.W	C.B.M	SIZE
Packing	25	16.50kg	17kg	0.09	600x500x300mm
13.903	Size: Ø95x485mm				

GROUND IRON SPIKE

new



INFORMATION

*mm

Easy to assemble by the own nature of the ground spike being driven pushed into the grass or soft grounds, providing a stable platform.

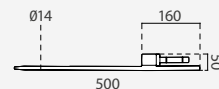

	QTY	N.W	G.W	C.B.M	SIZE
Packing	20	19kg	20kg	0.02	510x180x190mm
13.902	Size: Ø14x500x50mm				

FLAT CROSS BASE

new



INFORMATION

*mm

Powder coat iron finish. With rotor for 14.5 to 16.7mm tube. It is foldable and weighs 2.8kg. With holes for spikes (not included).

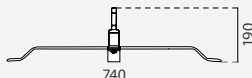

	QTY	N.W	G.W	C.B.M	SIZE
Packing	10	27.80kg	28.30kg	0.01	600x120x110mm
13.900		Size: 740x190x610mm			

TUBE CROSS BASE

new

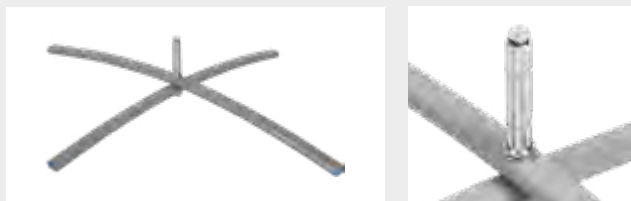

INFORMATION

*mm

For Outdoor and Indoor use. Made of iron, 1.5kg weight. With rotor for 14.5 to 16.7mm tubes. Foldable for an easy storage and transportation.

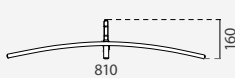

	QTY	N.W	G.W	C.B.M	SIZE
Packing	10	14kg	14.50kg	0.03	840x240x170mm
13.901	Size: 810x160x675mm				

ECONOMIC REFILLABLE BASE

new

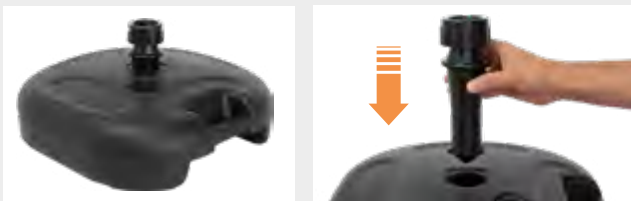

INFORMATION

*mm

Economic and refillable blow molding plastic base. Capacity: 20kg. With handle for better and easier transport. Black finish.

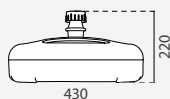

	QTY	N.W	G.W	C.B.M	SIZE
Packing	10	9.10kg	10.10kg	0.27	900x450x670mm
13.908	Capacity: 20kg	Size: 430x220x430mm			

DELUXE WITH ROTOR REFILLABLE BASE

new



INFORMATION

*mm

For Outdoor and Indoor use. Made of iron and plastic. Capacity: 12kg. With rotor for 14.5 to 16.7mm tubes. With handle for an easier transport.

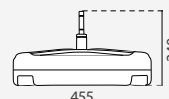

	QTY	N.W	G.W	C.B.M	SIZE
Packing	12	18kg	18.50kg	0.23	900x450x570mm
13.917	Capacity: 12kg	Size: 455x240x455mm			

WATER PLASTIC BAG

NEW



INFORMATION

*mm

Practical solution to add extra weight to the flag base. Made of PVC. Capacity: 10kg. Ideal to add over the rest of bases for flags.



	QTY	N.W	G.W	C.B.M	SIZE
Packing	100	17.10kg	17.60kg	0.06	390x390x400mm
13.909	Capacity: 10kg		Size: Ø530mm		

FLAT IRON BASE WITH SPINDLE

NEW



INFORMATION

*mm

Solid iron base with independent spindle. 6.3kg weight. Suitable for the Ref. 13.905 and 13.907. With handle for an easier transport.

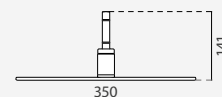

	QTY	N.W	G.W	C.B.M	SIZE
Packing	4	24kg	24.50kg	0.09	380x380x60mm
13.907	Thickness: 6mm		Size: 350x141x350mm		

45° INDEPENDENT BASE

NEW

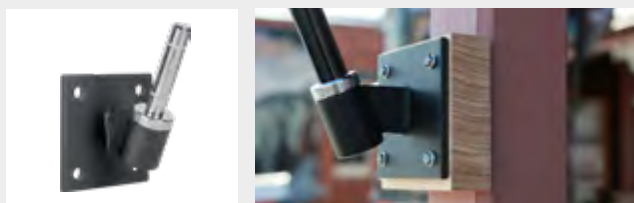

INFORMATION

*mm

45° iron base with rotor for 14.5 to 16.7mm tubes. Ideal for a fixed wall setup in adverse weather conditions or to withstand large flags. Suitable for Ref. 13.907.

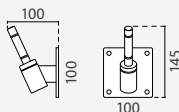

	QTY	N.W	G.W	C.B.M	SIZE
Packing	20	16.50kg	17kg	0.02	510x180x190mm
13.905	Size: 100x145x100mm				

90° INDEPENDENT BASE

NEW

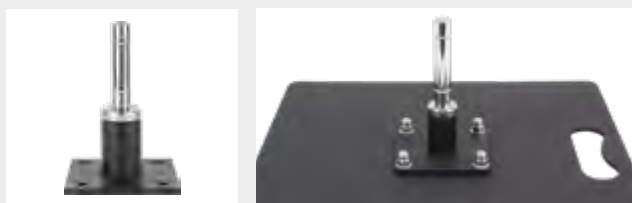

INFORMATION

*mm

90° iron base with rotor for 14.5 to 16.7mm tubes. Ideal for a wall fixing of large flags, or for being used with the flat base Ref. 13.907 (not included).

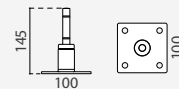

	QTY	N.W	G.W	C.B.M	SIZE
Packing	20	16.50kg	17kg	0.02	510x180x190mm
13.906	Size: 100x145x100mm				

FOLDABLE IRON BASE FOR WHEELS

NEW



INFORMATION

*mm

Foldable wheel base with rotor for 14.5 to 16.7mm flag tubes. Easy of use, just unfold and drive a vehicle wheel over base. With black finish.

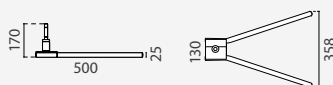

	QTY	N.W	G.W	C.B.M	SIZE
Packing	10	25.50kg	26kg	0.02	560x145x275mm
13.904	Size: 500x170x358mm				

OXFORD BAG FOR FLAG BANNERS

NEW

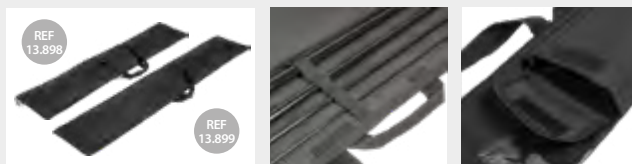

INFORMATION

*mm

Oxford Bag 13898 is suitable for: 2.8m Knife/spoon and 3.4m Spoon Flags and Oxford Bag 13899 is suitable for 3.4m knife and 4.5m/5.5m Knife/Spoon Flags.

	QTY	N.W	G.W	C.B.M	SIZE
Packing	60	30.50kg	31kg	0.16	620x560x450mm
13.898	Size: 950x200x30mm				
	QTY	N.W	G.W	C.B.M	SIZE
Packing	50	25.50kg	26kg	0.16	620x560x450mm
13.899	Size: 1210x200x30mm				

FLAG DETAILS

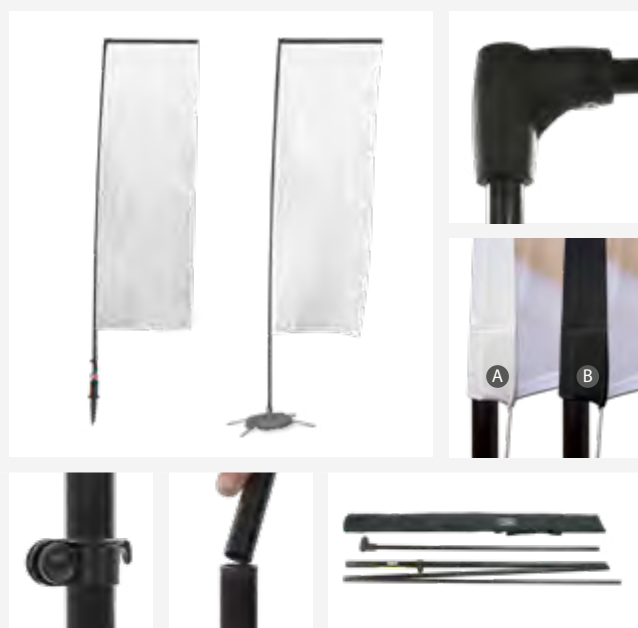

ARTWORK

*mm

SAFE ZONE
TOTAL GRAPHIC

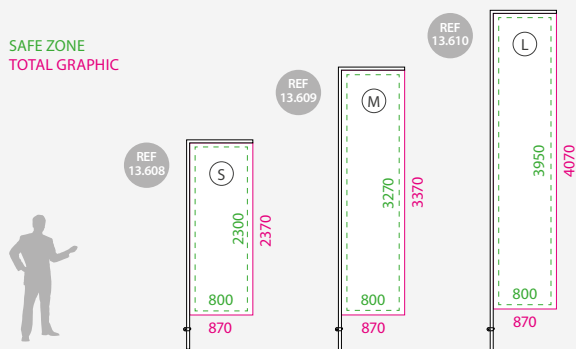

INFORMATION

ACCESSORIES AVAILABLE

Square flagpole is usually used for promoting on beaches. Its lightweight pole set-up and down in seconds for an improved storage. Carry bag included. Several accessories available later at this chapter. Textile manufacturing available (not included). You can choose **A** white or **B** black colour of pole sheath.

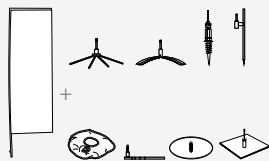

SQUARE	QTY	N.W	G.W	C.B.M	SIZE
13.608	1	0.94kg	1.44kg	0.004	80x50x1050mm
Graphic Size: 870x2370mm					
SQUARE	QTY	N.W	G.W	C.B.M	SIZE
13.609	1	1.46kg	1.96kg	0.005	100x50x1050mm
Graphic Size: 870x3370mm					
SQUARE	QTY	N.W	G.W	C.B.M	SIZE
13.610	1	1.80kg	2.30kg	0.005	100x50x1050mm
Graphic Size: 870x4070mm					

SQUARE



* Textile printing, bases and other accessories are available but not included. The price includes only the flagpole.

FLAG DETAILS



ARTWORK

*mm

SAFE ZONE
TOTAL GRAPHIC

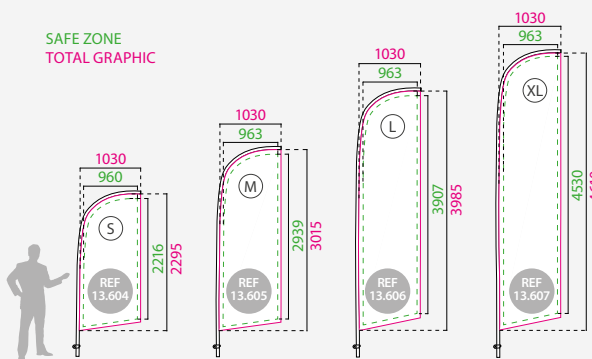

INFORMATION

ACCESSORIES AVAILABLE

The Knife is a flagpole made of fiberglass, aluminium and plastic. The pole is collapsible for an easy portability. Also, a carry nylon bag is included. Multiple accessories are available later at this chapter. Textile manufacturing available (not included). You can choose **A** white or **B** black colour of pole sheath.

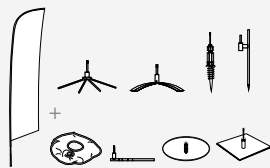

KNIFE



KNIFE S	QTY	N.W	G.W	C.B.M	SIZE
Packing	1	0.94kg	1.44kg	0.005	80x50x1410mm
13.604	S	Graphic Size: 1030x2295mm			
KNIFE M	QTY	N.W	G.W	C.B.M	SIZE
Packing	1	1.15kg	1.65kg	0.005	80x50x1410mm
13.605	M	Graphic Size: 1030x3015mm			
KNIFE L	QTY	N.W	G.W	C.B.M	SIZE
Packing	1	1.60kg	2.10kg	0.005	80x50x1410mm
13.606	L	Graphic Size: 1030x3985mm			
KNIFE XL	QTY	N.W	G.W	C.B.M	SIZE
Packing	1	1.65kg	2.15kg	0.006	90x50x1410mm
13.607	XL	Graphic Size: 1030x4610mm			

* Textile printing, bases and other accessories are available but not included. The price includes only the flagpole.

FLAG DETAILS



ARTWORK

*mm

SAFE ZONE
TOTAL GRAPHIC

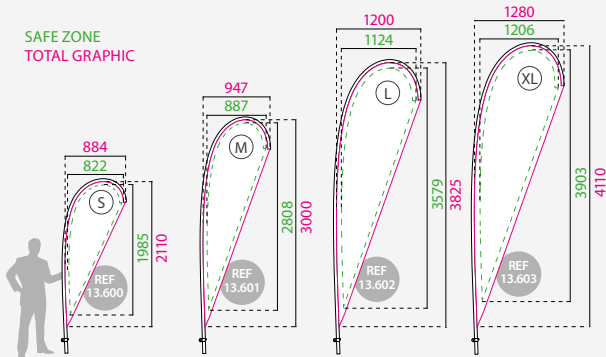

INFORMATION

ACCESSORIES AVAILABLE

The Spoon model is a flagpole made of fiberglass, aluminium and plastic. The pole is collapsible for an easy portability. Also, a carry nylon bag is included. Multiple accessories are available later at this chapter. Textile manufacturing available (not included). You can choose **A** white or **B** black colour of pole sheath.

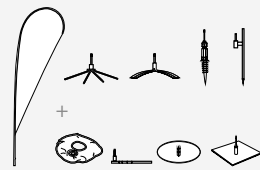

SPOON S	QTY	N.W	G.W	C.B.M	SIZE
Packing	1	0.67kg	0.72kg	0.004	65x50x1410mm
13.600	S	Graphic Size: 884x2110mm			
SPOON M	QTY	N.W	G.W	C.B.M	SIZE
Packing	1	1.07kg	1.57kg	0.005	80x50x1410mm
13.601	M	Graphic Size: 947x3000mm			
SPOON L	QTY	N.W	G.W	C.B.M	SIZE
Packing	1	1.49kg	1.99kg	0.005	80x50x1410mm
13.602	L	Graphic Size: 1200x3825mm			
SPOON XL	QTY	N.W	G.W	C.B.M	SIZE
Packing	1	1.78kg	2.28kg	0.005	80x50x1410mm
13.603	XL	Graphic Size: 1280x4110mm			

SPOON



* Textile printing, bases and other accessories are available but not included. The price includes only the flagpole.

OUTDOOR EVENTS Flag Banner Accessories



CROSS BASE WITH WATER PLASTIC BAG

3 L bag included



INFORMATION *mm

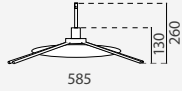

- With 3l refillable bag.
- Ideal for using with the larger flags, also can be used on uneven ground (even on slopes).

CROSS BASE	QTY	N.W	G.W	C.B.M	SIZE
Packing	40	28kg	31kg	0.115	620x460x720mm
Uni.	1	0.7kg	0.77kg	0.025	350x110x590mm

13.611

TIRE BASE U STYLE



INFORMATION *mm

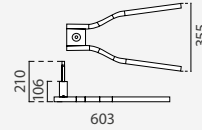

- Fast to assemble.
- Ideal for installation under car wheel thanks its U shape.

U STYLE	QTY	N.W	G.W	C.B.M	SIZE
Packing	20	34kg	37kg	0.138	540x400x640mm
Uni.	1	1.7kg	1.85kg	0.028	380x120x620mm

13.614

WATER PLASTIC BAG



3 L water

INFORMATION



- Great stability.
- Fast to assemble.
- Add an extra 3l weight.
- Suitable for Cross-Plate, Round and Square bases.

W.P.BAG	QTY	N.W	G.W	C.B.M	SIZE
Packing	20	3kg	4kg	0.006	200x150x200mm
Uni.	1	0.15kg	0.2kg	0.009	140x40x160mm

10.766

ROUND PLATE BASE



INFORMATION *mm

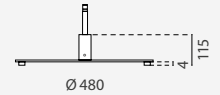

- Great stability.
- Fast to assemble.
- Recommended for an outdoor or indoor use with all Flying Banners.

ROUND	QTY	N.W	G.W	C.B.M	SIZE
Packing	1	8kg	8.5kg	0.014	530x45x590mm

13.615

GROUND DRILL



INFORMATION *mm

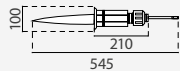

- Fast to assemble.
- For soft grounds, sand or snow. Ideal for displaying at the beach in summer or ski slopes in winter.

DRILL	QTY	N.W	G.W	C.B.M	SIZE
Packing	20	12kg	15kg	0.115	460x410x610mm
Uni.	1	0.6kg	0.75kg	0.025	390x110x590mm

13.612

SQUARE PLATE BASE



INFORMATION *mm

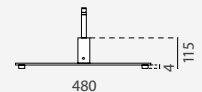

- Great stability.
- Fast to assemble.
- Recommended for an outdoor or indoor use with all Flying Banners.

SQUARE	QTY	N.W	G.W	C.B.M	SIZE
Packing	1	6kg	6.5kg	0.014	530x45x590mm

13.616

ROUND STRAIGHT SPIKE

ideal for grass or soft grounds



INFORMATION *mm

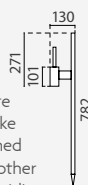

- Fast assembly.
- By the own nature of the ground spike being driven pushed into the grass or other soft grounds, providing a very stable platform.

SPIKE	QTY	N.W	G.W	C.B.M	SIZE
Packing	20	30kg	33kg	0.061	300x225x610mm
Uni.	1	1.5kg	1.65kg	0.009	55x40x590mm

13.613

CROSS PLATE BASE

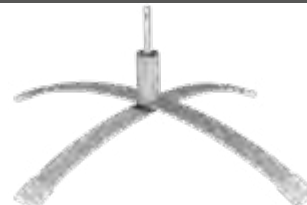

INFORMATION *mm

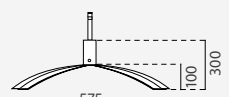

- Great stability.
- Fast to assemble.
- Ideal for concrete surfaces, footpaths or also, for indoor use.

CROSS	QTY	N.W	G.W	C.B.M	SIZE
Packing	5	21.5kg	24kg	0.030	320x120x800mm
Uni.	1	4.3kg	4.8kg	0.005	110x60x780mm

13.617

NEW

BACKPACK DETAILS



INFORMATION

DIMENSIONS

*mm

Comfortable backpack banner for street marketing. 4 banner holding systems are available. Featuring fiberglass structure, side and top pockets, shoulder/waist buckles, soft padded for back and telescopic poles or flag tensor depending on model.

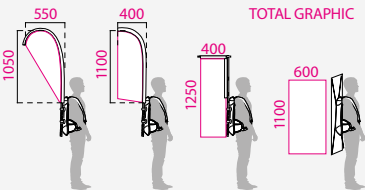

	QTY	N.W	G.W	C.B.M	SIZE
Packing	10	11.2kg	12.2kg	0.16	620x560x450mm
13.910	Graphic Size: 550x1050mm				
	QTY	N.W	G.W	C.B.M	SIZE
Packing	10	11.2kg	12.2kg	0.16	620x560x450mm
13.911	Graphic Size: 400x1100mm				
	QTY	N.W	G.W	C.B.M	SIZE
Packing	10	11.2kg	12.2kg	0.16	620x560x450mm
13.912	Graphic Size: 400x1250mm				
	QTY	N.W	G.W	C.B.M	SIZE
Packing	10	13kg	14kg	0.16	620x560x450mm
13.913	Graphic Size: 600x1100mm				

ECONOMIC BACKPACK FLAG BANNER



NEW

GOLF BANNER

BANNER DETAILS



DIMENSIONS AND KIT CONTENT

*mm

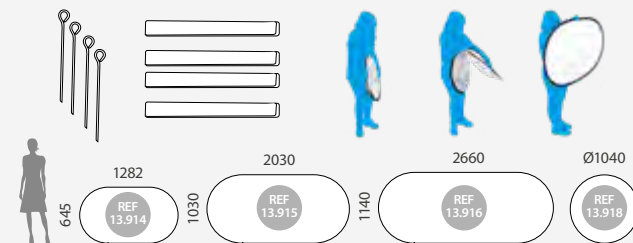

INFORMATION

This foldable banner is easily portable and lightweight. Its premium sprung metallic frame providing greater stability. With carry bag, spikes and pole connectors. Ideal for stand out your message at any indoors or outdoor event.

	QTY	N.W	G.W	C.B.M	SIZE
Packing	10	16kg	16.5kg	0.05	400x400x290mm
13.914	Graphic Size: 1282x645mm				
	QTY	N.W	G.W	C.B.M	SIZE
Packing	5	12kg	12.5kg	0.07	600x600x180mm
13.915	Graphic Size: 2030x1030mm				
	QTY	N.W	G.W	C.B.M	SIZE
Packing	5	15kg	15.5kg	0.1	730x730x180mm
13.916	Graphic Size: 2660x1140mm				
	QTY	N.W	G.W	C.B.M	SIZE
Packing	5	11kg	11.5kg	0.07	600x600x180mm
13.918	Graphic Size: Ø1040mm				



BUY AND SAVE
ECONOMIC
BEST DEAL

* Printing is available but not included.

STANDARD FLAG FINISHES

FASTENING

FLAG SEWING

BASIC SEWING



No fastening



Material: Made of Polyester 117g. Flag with basic sewing without fastening.

1



"D" Rings



Material: Made of polyester 117g. Includes three-sided perimeter folding and reinforcement on one side. With two "D" rings for fastening.

2

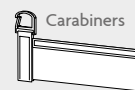

Carabiners



Material: Made of Polyester 117g. Includes three-sided perimeter folding and reinforcement on one side. With two plastic carabiners for fastening.

3

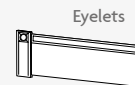

Eyelets



Material: Made of Polyester 117g. Includes three-sided perimeter folding and reinforcement on one side. With two eyelets for fastening.

4

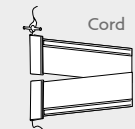
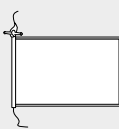

Cord

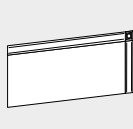

Material: Made of Polyester 117g. Includes three-sided perimeter folding and reinforcement on one side. With not elastic cord for fastening.

5

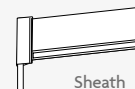
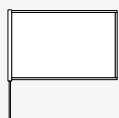

Sheath



Material: Polyester 117g. Includes 3-sided perimeter folding with Ø 20mm sheath.

6

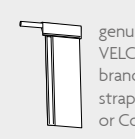
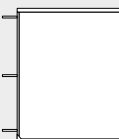

genuine
VELCRO®
brand
straps
or Cord



Material: Polyester 117g. Includes three-sided perimeter folding and one side reinforced. With genuine VELCRO® brand straps or cord for fastening.

7



Rings / Carabiners



Material: Polyester 117g. Includes three-sided perimeter folding and reinforcement on one side. With rings type "D" or carabiners for fastening.

FLAGS	SIZE	BASIC SEWING	1	2	4	5	7	3	6
10.379	700x1000mm								
10.882	1500x1000mm								
10.883	2000x1200mm								
10.884	2500x1500mm								

STANDAR FLAGS SYSTEM



OUTDOOR EVENTS Standard Flag System



C.E



Spain



France



Portugal



Germany



United Kingdom



Sweden



Austria



Belgium



Bulgaria



Cyprus



Czech Republic

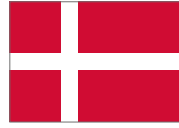

Denmark

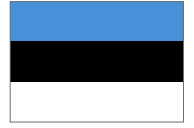

Estonia



Ireland



Italy



Latvia



Lithuania



Luxembourg

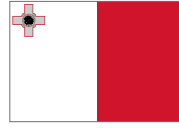

Malta



Finland



Romania



Slovakia



Slovenia



Poland



Greece



Hungary



Netherlands



Afghanistan



Albania



Algeria



Andorra



Argentina



Armenia



Australia



Barbados



Brazil



Cameroon



Canada



Chile



Colombia



Cuba



Ecuador



Egypt



Ethiopia



Guatemala



Haiti



Jamaica



Japan



Mexico



Panama



Qatar



Russia



Switzerland



Ukraine



United Arab Emirates



United States



Uruguay



Uzbekistan



Venezuela



Vietnam



Yemen



Zambia

Internationals



Unicef

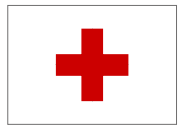

Red Cross

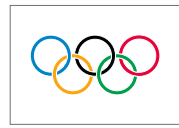

Olimpic Flags



Commonwealth



Autopro



Lannister



WWF

Universities



Uni. Rey Juan Carlos



Harvard



Cambridge



Yale

Sports



Cleveland Cavaliers



Chicago Bears

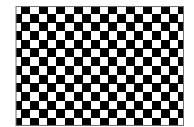

Checkered Flag

Enterprises

INFORMATION

The Wall Banner System is composed by a profile frame structure made of silver anodised lightweight aluminium and a full range of accessories for holding big size poster canvas. The wall banner system adopts a simple design to showcase your advertisement or promotional poster. Easy to assemble. The banner is attached by hanger clips through the grommets and fixed to the aluminium profile structure, allowing a simple and fast changing of the banner. Ideal for promoting your business or for displaying at outdoor exhibitions.

PROFILE FOR WALL BANNER

PROFILE DETAIL

DIMENSIONS *mm



REF
13.483

REF
13.484

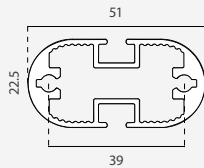

INFORMATION

Lightweight profile made of anodised aluminium, available in 2 or 3m length.

2m BARS	QTY	N.W	G.W	C.B.M	SIZE
Packing	2	3.92kg	4.40kg	0.0115	75x75x2037mm
13.484	Length: 2000mm		x2		
3m BARS	QTY	N.W	G.W	C.B.M	SIZE
Packing	4	11.77kg	12.80kg	0.048	145x110x3010mm
13.483	Length: 3000mm		x4		

CORNER SUPPORT FOR WALL BANNER

SUPPORT DETAILS

INFORMATION *mm

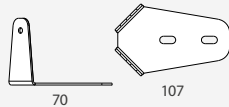

Made of 2mm sheet metal. It includes the fixing screws.

CORNER S.	QTY	N.W	G.W	C.B.M	SIZE
Packing	4	0.52kg	0.67kg	0.0021	105x120x165mm
13.485			x4		

STRAIGHT SUPPORT FOR WALL BANNER

SUPPORT DETAILS

INFORMATION *mm

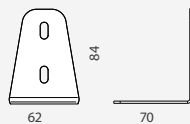

Made of 2mm sheet metal. It includes the fixing screws.

STRAIGHT S.	QTY	N.W	G.W	C.B.M	SIZE
Packing	4	0.41kg	0.56kg	0.0021	105x120x165mm
13.486			x4		

WALL BANNER SYSTEM





CORNER CONNECTION FOR WALL BANNER

CONNECTION DETAIL INFORMATION DIMENSIONS *mm

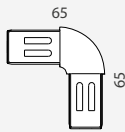

Corner Connection allows to connect aluminium profiles in the corner sections. It is made of polycarbonate. It includes the fixing screws.



CORNER C.	QTY	N.W	G.W	C.B.M	SIZE
Packing	4	0.14kg	0.30kg	0.0021	105x120x165mm
13.487				x4 	

CORNER GRIPS FOR WALL BANNER

GRIPS DETAIL INFORMATION DIMENSIONS *mm

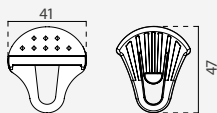

It allows to hang the banner with corners. Easy clip-on. Made of nylon.

CORNER GRIPS	QTY	N.W	G.W	C.B.M	SIZE
16.110				x40 	

CANVAS HANGERS FOR WALL BANNER

HANGER DETAIL INFORMATION DIMENSIONS *mm



This Hanger for wall banner allows to hang poster canvas and it is made of polycarbonate.

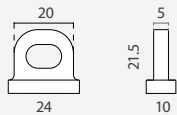

HANGERS	QTY	N.W	G.W	C.B.M	SIZE
13.334				x10 	

WALL BANNER SYSTEM

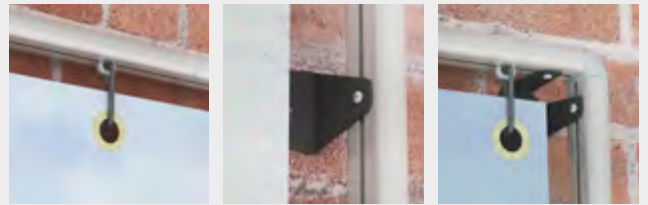



PROFILE CONNECTION FOR WALL BANNER

HANGER DETAIL INFORMATION DIMENSIONS *mm

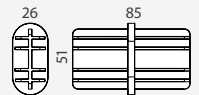

Profile Connection for the straight sections. Made of ABS plastic. Very easy setup.



PROFILE C.	QTY	N.W	G.W	C.B.M	SIZE
Packing	4	0.11kg	0.26kg	0.0021	105x120x165mm
13.488				x4 	

DIMENSIONS

*mm

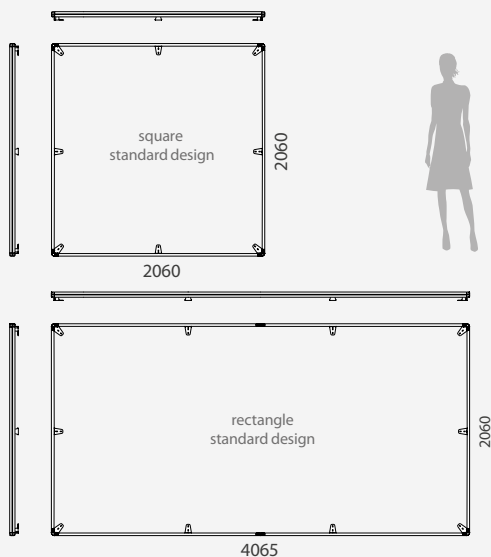

EXAMPLES STANDARD CONFIGURATION



PROFILE DETAILS



CANVAS PROFILE FOR BIG SIZES

LED

- EN Aluminium profile with or without light system suitable for indoor/outdoor assembly canvas. Specially designed for large areas.
- FR Système de profil approprié pour toiles géantes ou de grandes aires. Disponible avec ou sans lumière, pour l'extérieur ou l'intérieur.
- PT Sistema de perfil com iluminação para impressões de grande formato ou grandes superfícies. Adequado para interior o exterior.
- ES Sistema de perfil adecuado para lonas gigantes o grandes áreas. Disponible con o sin sistema de luz y adecuado para exterior e interior.



TEXFIX DETAILS



INFORMATION

Click system frame available with or without LED System. Each Canvas Kit contains: Aluminium profiles, hanger canvas, corner connections, Led systems, power supply. The Power supplies are always placed outside the aluminium frame of the TexFix. Ideal for giant prints destined for out-of-home campaigns. It has a simple banner attachment system for banners destined either for outdoor or indoor environments. In many different applications, and specially designed for large areas, Canvas Profile can provide the answer for a smarter, better customized banner framing solution. Canvas profile is supplied in 3 standard kit sizes. There is a full range of possibilities, each suited to specific applications. Contact us for more details and information.

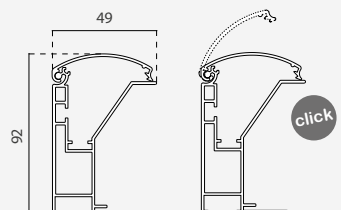

*mm

PROFILE STANDARD SIZES



CANVAS PROFILE FOR BIG SIZES



CANVAS PROFILE STANDARD SIZES (INCLUDES LED)

CANVAS PRO	GRAPHIC SIZE
13.737	550x1300mm
13.738	1050x2540mm
13.739	1150x5040mm

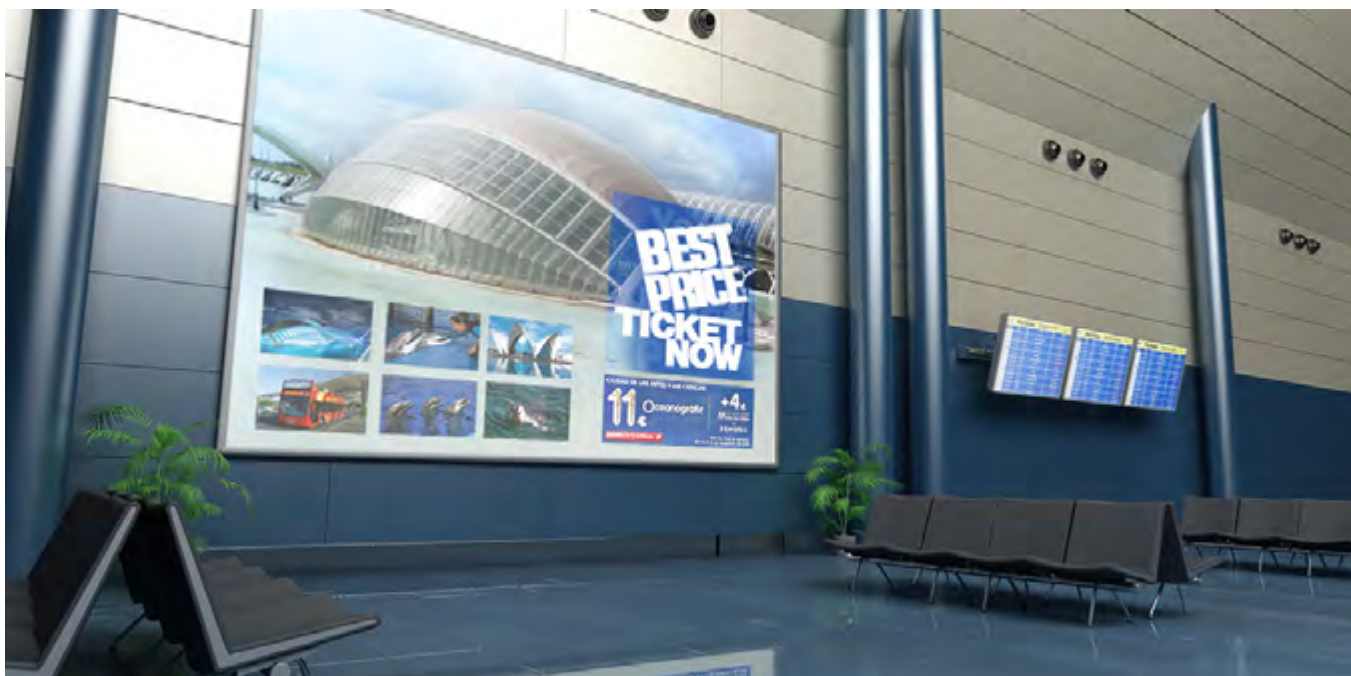

HANGERS FOR CANVAS PROFILE

HANGER DETAILS DIMENSIONS *mm

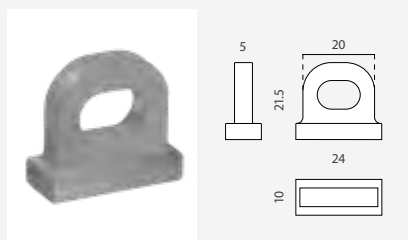

INFORMATION

This Hanger for Canvas profile is made of plastic and it is designed for holding canvas all along the profile. It is sold in 10 unit pack.

HANGER

13.334 x10 

WALL HANGERS FOR CANVAS PROFILE

HANGER DETAILS DIMENSIONS *mm



Wall Hanger for Canvas is suitable for being used with the next profiles:

TexFix Canvas
TexFix UltraSlim
TexFix 80

WALL HANGER	QTY	N.W	G.W	C.B.M	SIZE
Packing	4	0.31kg	0.45kg	0.0004	85x45x115mm
13.708	x4 				

*This Canvas Profile does not included the power cable connector.

WALL POLE SUPPORT STREET BANNER

SUPPORT DETAILS



KIT CONTENT

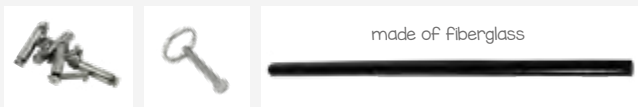

INFORMATION

*mm

Suitable for wall-mounting. Each kit consists of a Ø19mm pole, 1 metallic bracket, 1 pin with ring and mounting screws. Easy and fast banner change by removing the pin connecting the pole to the Wall-mounted bracket.

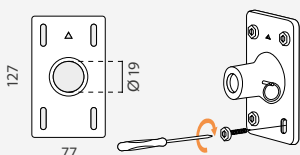

SCREW

10.202	Pole 800mm		
10.203	Pole 1000mm		

LAMP POLE CLAMPS STREET BANNER

SUPPORT DETAILS



KIT CONTENT



INFORMATION

*mm

Suitable for outdoor lamps/posts. Each kit consists of a Ø19mm pole, 1 metallic bracket, 1 pin with ring and metallic adjustable bands. Easy banner change by removing the pin connecting the pole to the bracket.

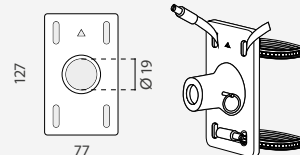

CLAMPS

10.071	Pole 800mm		
10.072	Pole 1000mm		

WALL SUPPORT STREET BANNER

SUPPORT DETAILS



INFORMATION

*mm

This Banner Support is suitable for wall-mounting. Each kit consists of 2 brackets support and mounting screws. The Wall Support is ideal for hanging big size banners from the street.

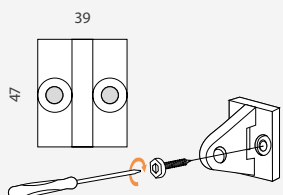

MINI-SCREW

10.100	Wall-Mounted		
--------	--------------	--	--

LAMP CLAMPS STREET BANNER

SUPPORT DETAILS



INFORMATION

*mm

Suitable for outdoor lamps/posts. Each kit consists of 2 brackets support and metallic adjustable bands. The Lamp Clamps are ideal for hanging big size banners at outdoor placements.

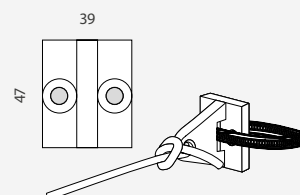

MINI CLAMPS

10.099	Hose Clamps		
--------	-------------	--	--

SUPPORT DETAILS

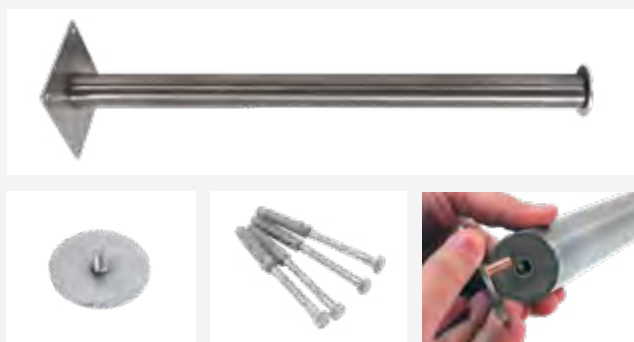

DIMENSIONS

*mm



INFORMATION

Wall Pole features a heavy gauge stainless steel pole to which the flag banner is sleeved and securely mounted to the wall. Designed for resisting strong weather conditions. With a Ø60mm cap. Easy to assemble. Wall fixing screws included.

POLE 450	QTY	N.W	G.W	C.B.M	SIZE
Packing	2	2.20kg	2.64kg	0.0112	160x130x540mm

10.453 Pole Size: Ø 40x450mm x2 

POLE 600	QTY	N.W	G.W	C.B.M	SIZE
Packing	2	2.46kg	3.00kg	0.0139	160x130x670mm

10.454 Pole Size: Ø 40x600mm x2 

WALL POLE



SUPPORT DETAILS



DIMENSIONS

*mm

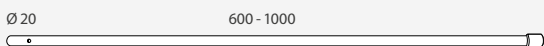

INFORMATION

This support is designed for resisting strong wind conditions, ideal for outdoor lamps/posts from the street. Each kit consists of a Ø20mm fiberglass pole (2 length available), 1 aluminium bracket, 1 pin, 1 ring and 2 stainless steel bands.

LAMP S. 600	QTY	N.W	G.W	C.B.M	SIZE
Packing	1	0.6kg	1.0kg	0.0039	100x65x610mm

12.454 Pole 600mm x2 

LAMP S. 1000	QTY	N.W	G.W	C.B.M	SIZE
Packing	1	1.0kg	1.35kg	0.006	100x65x1010mm

12.353 Pole 1000mm x2 

LAMP SYSTEM

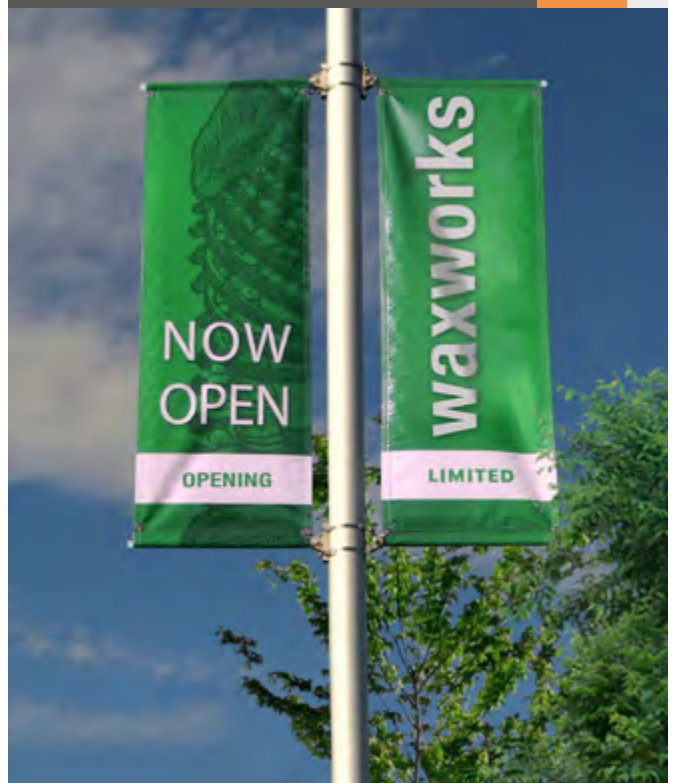

DISPLAY DETAILS





INFORMATION

DIMENSIONS

*mm

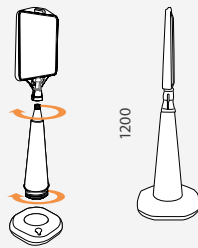
Charleroi is a 2-sided outdoor banner made of plastic, easy to install. It allows to fix 330x382mm graphics. Its base can be filled with 4l of water or sand, which adds stability to the banner. Also, it allows the barriers mounting thanks to its 2 chain connections. Lightweight for transport. It is ideal for indoor or outdoor use like shop entrances, sidewalks gardens, restaurant terraces, etc.



	QTY	N.W	G.W	C.B.M	SIZE	
Packing	1	2kg	2.5kg	0.07	500x200x690mm	
10.248	Graphic Size: 330x382mm					

CHARLEROI

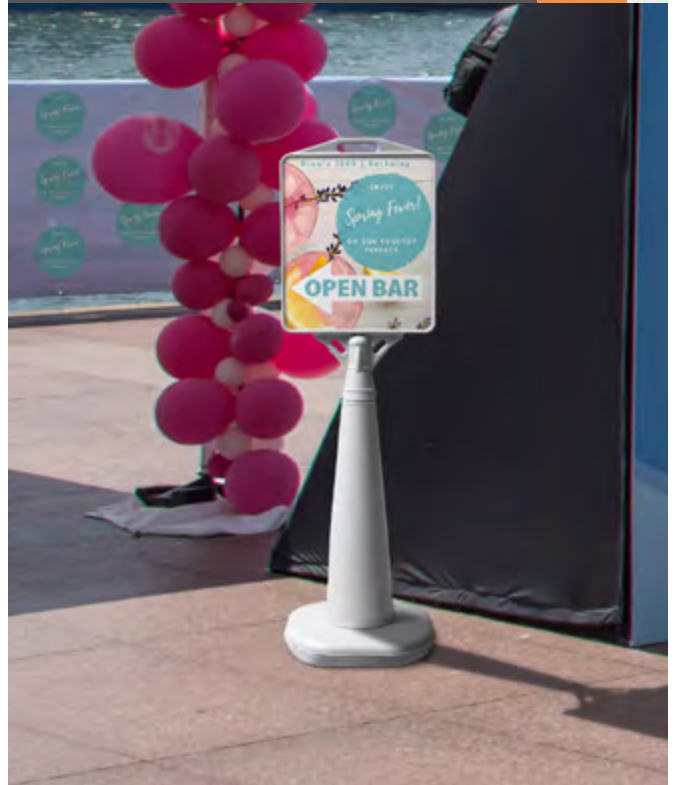

DISPLAY DETAILS

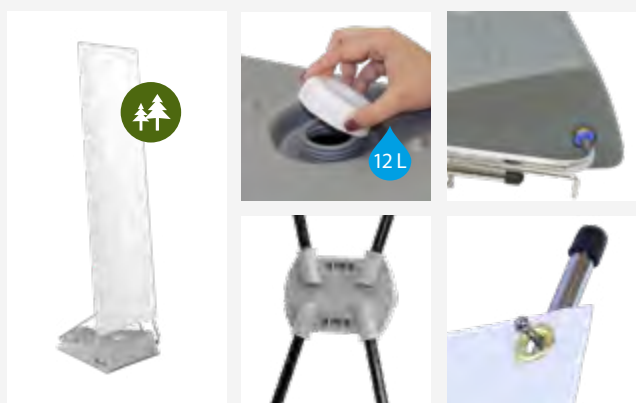



INFORMATION

*mm

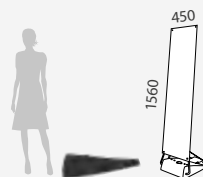
Medinaceli is a detachable stand display with a refillable 12l water plastic base which is suitable for indoor and outdoor use. The change of graphic is simple and takes only a few seconds. Includes a nylon Carry Bag for an easy transport and storing.



	QTY	N.W	G.W	C.B.M	SIZE	
Packing	2	7kg	8.6kg	0.11	540x190x1050mm	
Uni.	1	2.85kg	3.50kg	0.05	500x100x1030mm	
10.026	Graphic Size: 450x1560mm					

MEDINACELI



DISPLAY DETAILS



INFORMATION

*mm

This portable and detachable display stand features a water refillable base, 6 litres capacity. Made of fiberglass, plastic and lacquered aluminium. Suitable for indoor and outdoor use, features an easy interchange of graphics. Carry bag is included.

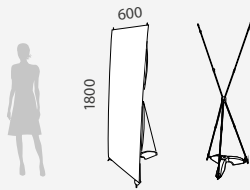

	QTY	N.W	G.W	C.B.M	SIZE	
Pole	1	0.55kg	0.6kg	0.004	80x65x750mm	
Base	1	0.95kg	1kg	0.015	250x170x350mm	
10.028	Graphic Size: 600x1800mm					

ALMAZAN



DISPLAY DETAILS



INFORMATION

*mm

This portable and detachable display stand features a water refillable base, 6 litres capacity. Made of fiberglass, plastic and lacquered aluminium. Suitable for indoor and outdoor use, features an easy interchange of graphics and adjustable height (telescopic). Carry bag is included.

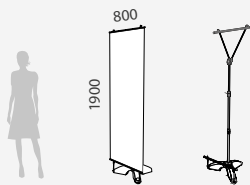

	QTY	N.W	G.W	C.B.M	SIZE	
Packing	6	13kg	16.20kg	0.1	400x320x850mm	
Uni.	1	1.8kg	2.2kg	0.02	240x100x840mm	
10.029	Graphic Size: 800x1900mm					

ALMENAR



BASE DETAILS



BASE DETAILS







INFORMATION

With a durable design and easy portability, this double-sided base with corrugated plastic insert is ideal for placing outdoors, in areas with high foot traffic to draw in new customers. The weighted poster holder can be filled with up to 5l of water or sand. This base is available on Grey or black color.

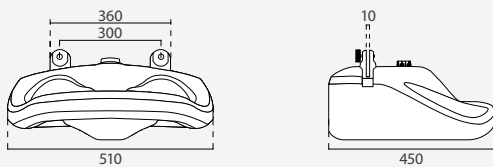
DIMENSIONS

*mm



	QTY	N.W	G.W	C.B.M	SIZE	
Packing	1	2kg	2.55kg	0.04	440x190x520mm	 
10.442		Distance Between Holes: 300mm				
10.443						

PANELFIX WING
OUTDOOR



* Boards are available but not included. The price includes only the base.

DISPLAY DETAILS

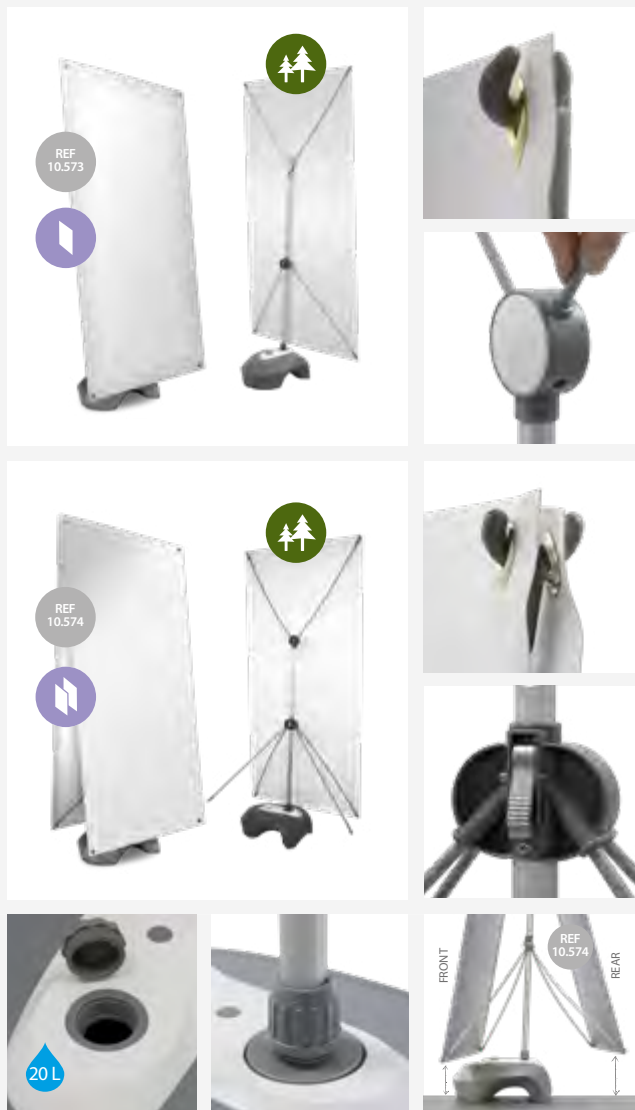

INFORMATION

*mm

This stand display features a 20l water refillable base. The central telescopic hub allows fast height adjustment. Kiel is ideal for indoor or outdoor use. Graphics are held with a simple and fast eyelet system. Kiel 10.574 can be used to present a double-sided graphic in areas with 2-ways traffic (after the placement of graphs, the distance to the ground on both sides can differentiate each other: $\pm 50\text{mm}$).

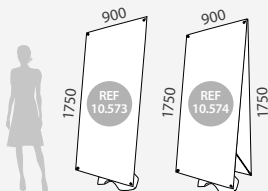

KIEL



KIEL SINGLE	QTY	N.W	G.W	C.B.M	SIZE
Packing	1	2.8kg	3.25kg	0.09	400x200x1080mm
10.573	Graphic Size: 900x1750mm				
KIEL DOUBLE	QTY	N.W	G.W	C.B.M	SIZE
Packing	1	3kg	3.45kg	0.09	400x200x1080mm
10.574	Graphic Size: 900x1750mm x2				

BANNER SUPPORT DETAILS

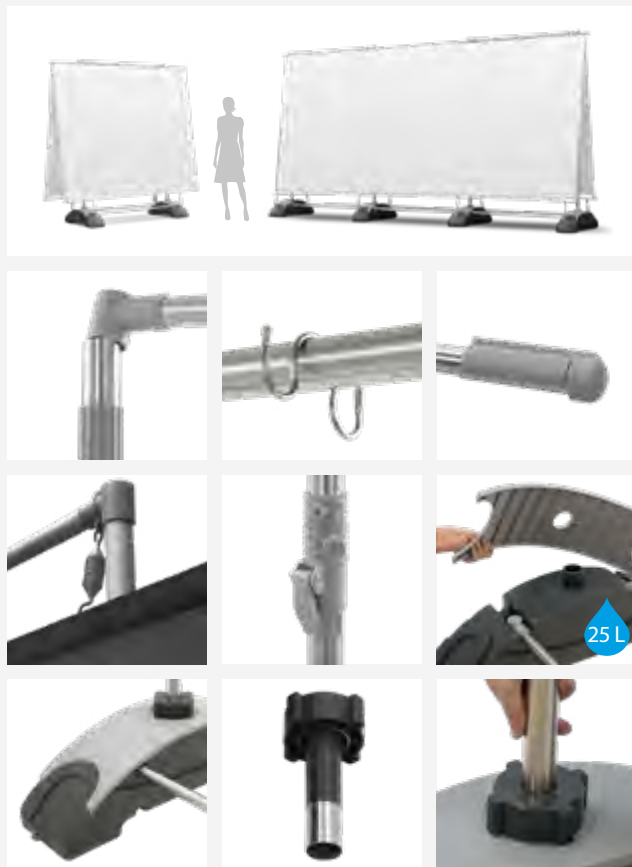

DIMENSIONS

*mm

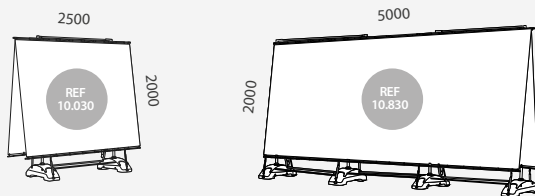

INFORMATION

The Barahona 10.030 Model features 2 Bases (fill each one with 25l water or sand) and a one or two-sided design for displaying large graphic banners so it is perfect for an outdoor use where bases can resist strong wind conditions. The Barahona 10.830 features 4 Bases (fill each one with 25l of water or sand). Its 4 ultra-large bases are very stable for an outdoor use, which ones are available to resist strong wind conditions. This Barahona model is the first choice for a huge outdoor display background (visual: 5000x2000mm).

BARAHONA 1	QTY	N.W	G.W	C.B.M	SIZE
Pole	1	11.5kg	16kg	0.04	410x210x1660mm
Base	1	8kg	9kg	0.11	430x310x850mm

10.030 Graphic Size: 2500x2000mm

BARAHONA 2	QTY	N.W	G.W	C.B.M	SIZE
Pole	1	17.2kg	21.1kg	0.044	170x150x1720mm
Base	1	13.3kg	18.3kg	0.12	470x300x850mm

10.830 Graphic Size: 5000x2000mm

BARAHONA



SIDELINE BANNER DETAILS



*Printed on fabric.
Impression sur toile.
Impressão em tecido.
Impresión en tela.

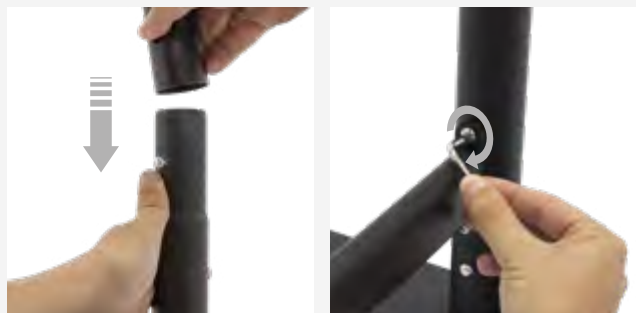

DIMENSIONS

ARTWORK

*mm

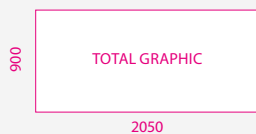
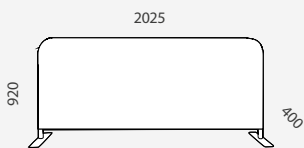

INFORMATION

This promotional Sideline Banner features a lightweight aluminum structure, the design of its structure allows its customization with a double-sided textile cover for printing your advertisement or your own corporate logo. Includes carrying bag and it is supplied with stakes for fixing to the ground.

	QTY	N.W	G.W	C.B.M	SIZE
Packing	1	6kg	7kg	0.0295	910x270x120mm
10.791	Graphic Size: 2050x900mm				

MANAUS SIDELINE BANNER



SIDELINE BANNER DETAILS



EXTERNAL SIZE

ARTWORK

*mm

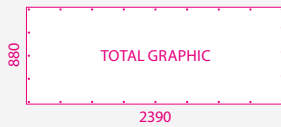
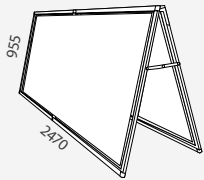

INFORMATION

This promotional Sideline Banner is made of lightweight aluminum, the design of its structure allows its customization with a double-sided canvas for printing your advertisement or your own corporate logo. Includes carrying bag for an easy transportation and storing.

	QTY	N.W	G.W	C.B.M	SIZE
Packing	1	5kg	6kg	0.035	170x170x1220mm
10.548	Graphic Size: 2390x880mm				

**PARANA
SIDELINE BANNER**

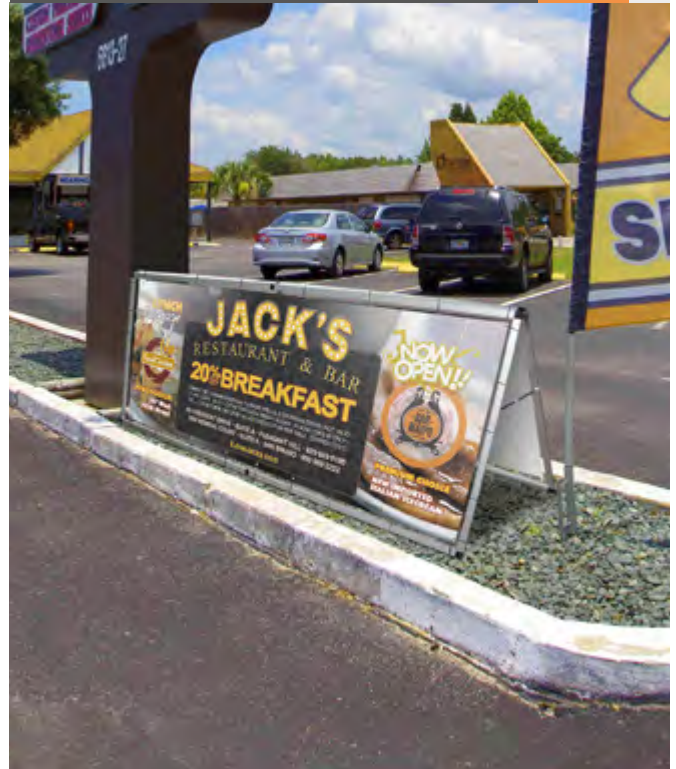

SIDELINE BANNER DETAILS



DIMENSIONS

*mm

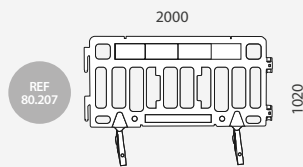
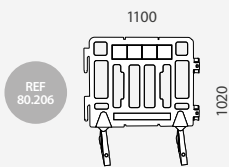

INFORMATION

This promotional barrier banner is made of lightweight plastic, features a bottom space for customizing, has reflective stripes at the top and rotating bases. Ideal for events thanks to its linkable design. Includes carrying bag for an easy transportation. 1100mm or 2000mm width available.

BARRIER 1100	QTY	N.W	G.W	C.B.M	SIZE
Packing	1	8.95kg	9.95kg	0.086	1070x70x1150mm
80.206	External Size: 1100x1020x50mm				

BARRIER 2000	QTY	N.W	G.W	C.B.M	SIZE
Packing	1	13kg	14kg	0.153	1070x70x2050mm
80.207	External Size: 2000x1020x50mm				

**LINKABLE
SIDELINE BANNER**





Stanchions

04

Collection of belt and rope stanchions and its proper accessories for creating guide patrons and configurations of queuing systems.

- 186** BELT STANCHIONS
- 191** BELT STANCHIONS ACCESSORIES
- 192** WALL BELT BARRIER
- 193** ROPE STANCHIONS
- 196** ROPE STANCHIONS ACCESSORIES



STANCHIONS DETAILS

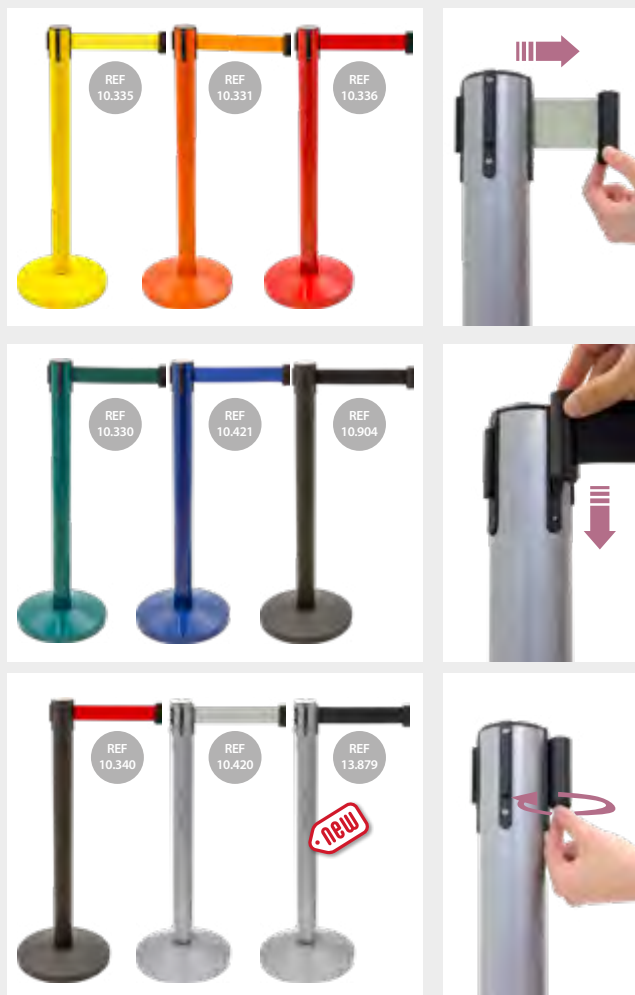

CLASSIC STANCHION WITH RETRACTABLE BELT



INFORMATION DIMENSIONS *mm

These 910mm height Stanchions have a Ø63mm pole and they are constructed from sturdy, durable powder coated steel. Featuring a Ø320mm cement dome base and a 2m retractable belt with security lock and built-in 4-way adaptor which expands its possibilities. Easy to assemble & disassemble (for storing or transport). Ideal for higher traffic areas like lobbies, waiting areas, airports, food lines or registration offices.

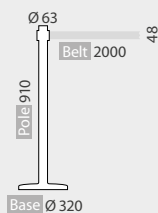

CLASSIC STANCHION WITH RETRACTABLE BELT

	POLE COLOR	BELT COLOR	
10.335	Yellow 1235C 	Yellow 107C 	
10.331	Orange 2027C 	Orange 394C 	
10.336	Red 2035C 	Red 206C 	
10.330	Green 323C 	Green 561C 	
10.421	Blue 280C 	Blue 286U 	x2 
10.904	Black 6C 	Black 3C 	
10.340	Black 6C 	Red 206C 	
10.420	Grey 2162C 	Grey 7537C 	
13.879	Grey 2162C 	Black 3C 	

STANCHIONS DETAILS

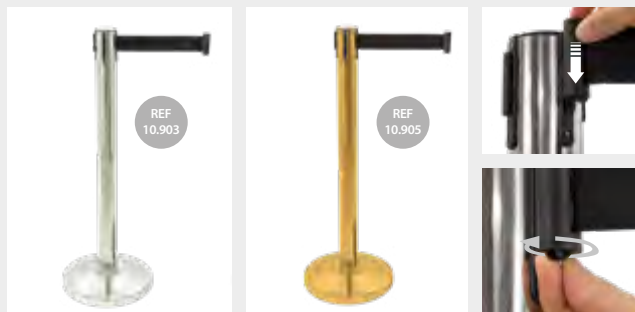

INFORMATION

This 910mm height Polished Stylish Stanchion has a Ø63mm pole made with durable steel parts (silver or golden color available). With a Ø320mm cement dome base which adds stability to the stanchion and 2m retractable black belt with security lock and built-in 4-way adaptor which expands possibilities. Easy to assemble and disassemble (for storing or transport). Ideal for higher traffic areas like lobbies, airports, registration offices and anywhere else you have the need to guide patrons.

DIMENSIONS *mm

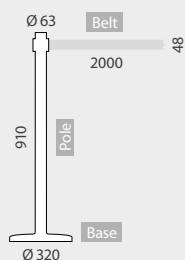

POLISHED STANCHION

	POLE COLOR	BELT COLOR	OUTER SIZE	
10.903	Silver	Black 3C	Ø320x910mm	x2
10.905	Golden	Black 3C	Ø320x910mm	x2

POLISHED STANCHION WITH RETRACTABLE BELT



STANCHIONS DETAILS



INFORMATION

This 910mm height Stanchion has a Ø63mm pole. It is constructed with sturdy, durable steel parts (3 colors available: blue, black or silver). Its Ø320mm cement dome base adds stability to the stanchion and the double 2m retractable belt built-in 4-way adaptor expands possibilities. It is easy to assemble & disassemble (for storing or transport). Ideal for higher traffic areas like lobbies, waiting areas, airports, food lines, registration offices and anywhere else you have the need to guide patrons.

DIMENSIONS *mm

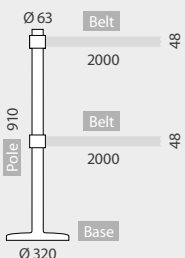

DOUBLE BELT STANCHION

	POLE COLOR	BELT COLOR	OUTER SIZE	
10.927	Black 6C	Black 3C	Ø320x910mm	x2
10.928	Blue 280C	Blue 286U	Ø320x910mm	x2
10.926	Silver	Black 3C	Ø320x910mm	x2

DOUBLE RETRACTABLE BELT STANCHION



STANCHIONS DETAILS





INFORMATION

This 910mm height Stanchion has a Ø63mm pole. It is constructed from sturdy, durable powder coated steel, available in red or yellow. Its Ø320mm cement dome base adds stability to the stanchion. The 2m striped retractable belt and a built-in 4-way adaptor expands the possibilities. Easy to assemble & disassemble (for storing or transport). It is ideal for areas like hangars, warehouses, factories areas, airports, work lines and any where it is necessary to protect areas or to mark zones of prohibited access.

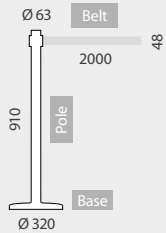
DIMENSIONS *mm



HIGH VISIBILITY STANCHION

	POLE COLOR	BELT COLOR		
13.705	Yellow 1235C	Y 108C/B 3C		x2 
13.706	Red 2035C	R 185C/White		

HIGH VISIBILITY STANCHION WITH STRIPED BELT



STANCHIONS DETAILS

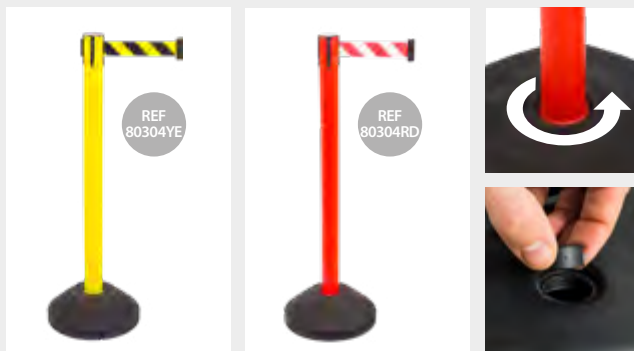



INFORMATION

This 910mm height Stanchion has a Ø63mm pole available in red or yellow color. Featuring a plastic base that can be filled with 1 kg of weight, which adds stability to the stanchion, a 2100mm striped retractable belt and a built-in 4-way adaptor which expands the possibilities. This stanchion is easy to assemble & disassemble (for storing or transport). It is ideal for areas like hangars, warehouses, factories areas, for airports, work lines and for any where it is necessary to protect areas or to mark zones of prohibited access.

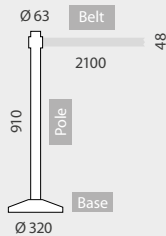
DIMENSIONS *mm



STANCHION WITH REFILLABLE BASE

	POLE COLOR	BELT COLOR		
80304YE	Yellow	Yellow/Black		x6 
80304RD	Red	Red/White		

HIGH VISIBILITY STANCHION WITH REFILLABLE PLASTIC BASE

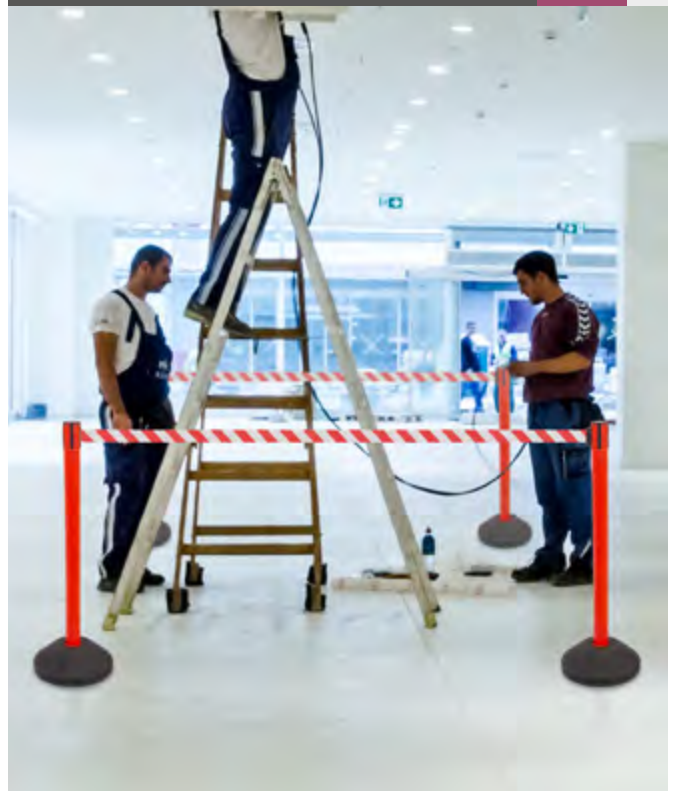

STANCHIONS DETAILS

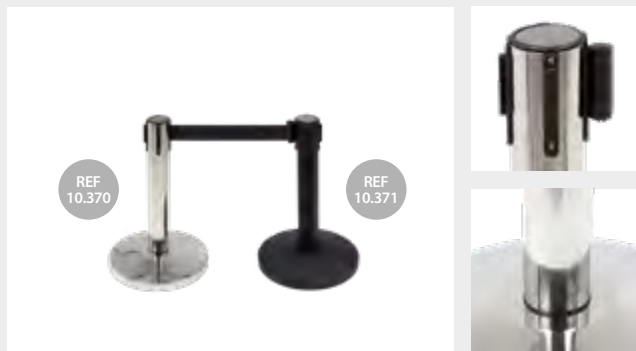

INFORMATION

This 500mm height Stanchion is constructed with durable steel parts. It is available in 2 colors: silver or black finish. With a Ø63mm pole, a Ø320mm cement dome base which adds stability to the stanchion and a 2m black retractable belt and a built-in 4-way adaptor which expands possibilities. Easy to assemble & disassemble (for storing or transport). It is ideal for dealers, museums, galleries or for showrooms thanks to its small dimensions which allows a perfect exhibition.



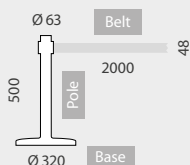



DIMENSIONS *mm



SMALL STANCHION WITH RETRACTABLE BELT



SMALL STANCHION

	POLE COLOR	BELT COLOR		
10.370	Silver	 Black 3C		x2 
10.371	Black	 Black 3C		x2 

STANCHIONS DETAILS

ROLLER USE



INFORMATION

This 910mm height Stanchion is constructed from sturdy, durable powder coated steel. It features a Ø63mm pole and a Ø360mm base with side roller which allows an easy transport of the stanchion to any other place where it is used. Also it features a 2m retractable black belt built-in 4-way adaptor which expands the possibilities. Easy to assemble & disassemble (for storing). Ideal for higher traffic areas at specific times of the day like lobbies, airports or registration offices.



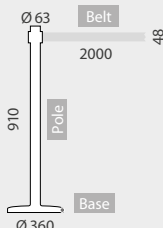



DIMENSIONS *mm



ROLLER STANCHION WITH RETRACTABLE BELT



ROLLER STANCHION

	POLE COLOR	BELT COLOR		
10.930	Black	 Black 3C		x2 
10.929	Silver	 Black 3C		x2 

STANCHIONS DETAILS



INFORMATION



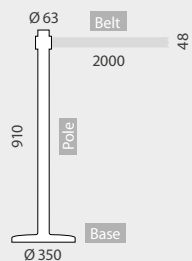

This 910mm height Stanchion is constructed with sturdy, durable steel parts, available in silver or black finish. Featuring a Ø63mm pole, a Ø350mm metallic base which adds stability to the stanchion, a 2m black retractable belt and a built-in 4-way adaptor which expands the possibilities. Easy to assemble & disassemble (for storing or transport). It is ideal for dealers, museums, for galleries, airports or for showrooms, thanks to the special design of its base, suitable for stacking the poles.

DIMENSIONS

*mm



STACKABLE STANCHION

	POLE COLOR	BELT COLOR	OUTER SIZE		
10.121	Black 	Black 	Ø350x910mm	x2	
10.118	Silver 	Black 	Ø350x910mm	x2	

STACKABLE STANCHION WITH RETRACTABLE BELT

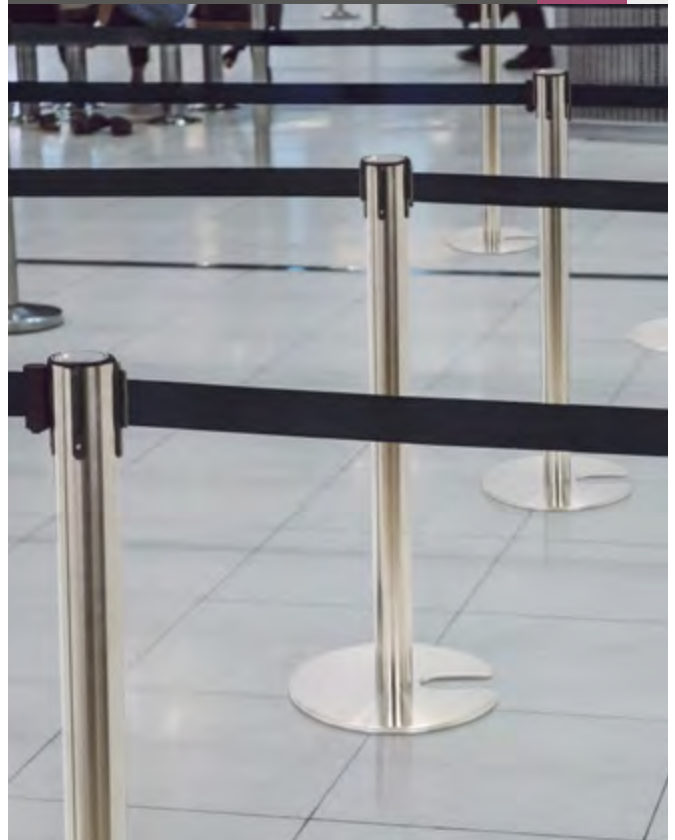

BOWLS DETAILS



INFORMATION

These bowls are suitable for poles up to Ø63mm. They are ideal for arranging brightening queues with business cards, candies or goodies at tradeshows, airports, theaters, or lobbies for displaying promotional items of the event.

DIMENSIONS

*mm

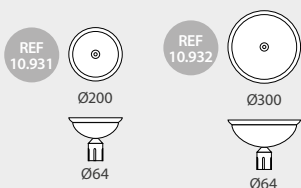

BOWL WITH CONNECTOR

	Ø BOWL	
10.931	200mm	
10.932	300mm	

BOWL AND CONNECTOR



FRAMES DETAILS



INFORMATION

This frame for retractable belt stanchions provides a solid support for signage in queuing. You can insert a graphic element through the top of the frame. Includes two-sided graphic holder system. It is available in gold or silver color. Ideal for use in museums, galleries, exhibitions, showrooms or retailers.

DIMENSIONS

*mm

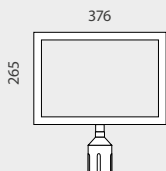

SIGN BOARD WITH CONNECTOR

	FRAME COLOR		GRAPHIC SIZE
10.916	Silver		370x260x3mm
10.917	Golden		370x260x3mm

SIGN BOARD FOR STANCHIONS



* the stanchions at this page are available but not included

WALL BELT BARRIER Wall Barrier

BELTS DETAILS



INFORMATION

With 2m long retractable belt in several colors. Wall receiver and screws included.

DIMENSIONS

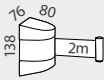

INCLUDED KIT



*mm

	CASE COLOR	BELT COLOR	BELT LENGTH
13.700	485C	206C	2m
13.701	Black 6C	Black 3C	2m
13.702	7549C	107C	2m
13.703	485C	R 185C/White	2m
13.704	7549C	Y108C/B 3C	2m

BELTS DETAILS



INFORMATION

With 3 lengths black and yellow striped retractable belt. Wall receiver and screws included.

DIMENSIONS

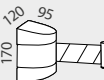

INCLUDED KIT



*mm

	CASE COLOR	BELT COLOR	BELT LENGTH
13.767	Yellow/Black	Yellow/Black	3m
13.768	Yellow/Black	Yellow/Black	5m
13.769	Yellow/Black	Yellow/Black	10m

BELTS DETAILS



INFORMATION

With 2m long black retractable belt. 3-way belt adaptor. Wall receiver and screws are included.

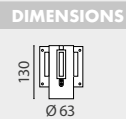

INCLUDED KIT



*mm

	CASE COLOR	SIZE	BELT COLOR	BELT LENGTH
10.918	Black	Ø63x130mm	Black	2m
10.975	Silver	Ø63x130mm	Black	2m

CONNECTOR DETAILS

INFORMATION

*mm



This receiver is made of plastic and it is ideal as wall connector for the retractable belts. Screws are included.

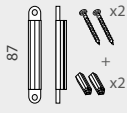

	LENGTH
10.918P	87mm

WALL BARRIER WITH RETRACTABLE BELT

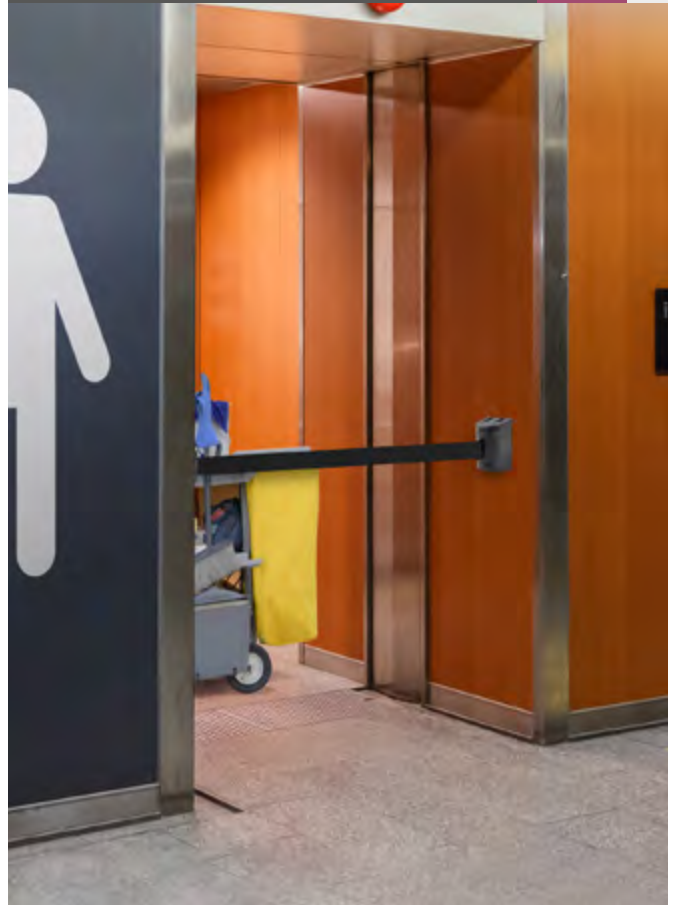

WALL MOUNTED TENSOROPE SUPPORT



WALL RECEIVER



STANCHION DETAILS



INFORMATION

*mm

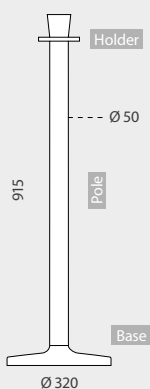

This traditional Stanchion features a royal stylish top with tulip shape. It features a 915mm high Ø50mm pole and it is made of a sturdy and durable steel parts with polished chrome finish. Also, it has a Ø320mm notched cement dome base which adds stability to the stanchion and built-in 4-way ring holder which expands the possibilities. It is ideal to add a touch of distinction to your queuing controls thanks to its classic design top, so it is perfect for being used at higher traffic areas like hotels, theaters, lobbies, restaurants, at the airports or anywhere else you have the need to guide patrons.



TULIP EXCELSIOR STANCHION



TULIP STANCHION

	POLE COLOR	Ø POLE	Ø BASE	HEIGHT	
10.207	Chrome 	50mm	320mm	915mm	x2 

* ropes at this page are available but not included

STANCHION DETAILS

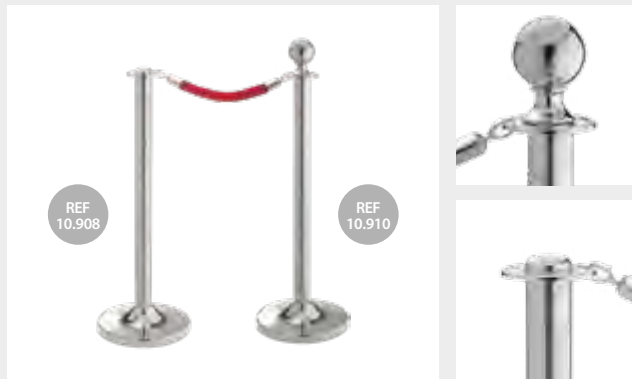

INFORMATION

This classic Stanchion features flat or ball top. It is constructed with sturdy, durable steel parts with polished chrome finish. With a Ø50mm pole, a Ø320mm cement dome base which adds stability to the stanchion and a built-in 4-way ring holder. Ideal for higher traffic areas like theaters, lobbies, restaurants, airports or anywhere else you have the need to guide patrons.

DIMENSIONS *mm

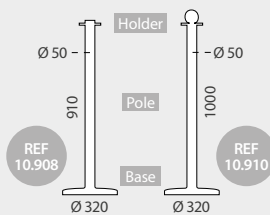

CLASSIC CHROMED STANCHION

	POLE COLOR		Ø POLE	Ø BASE	HEIGHT	
10.908	Chrome		50mm	320mm	910mm	x2 
10.910	Chrome		50mm	320mm	1000mm	x2 

CLASSIC CHROMED STANCHION FOR ROPES

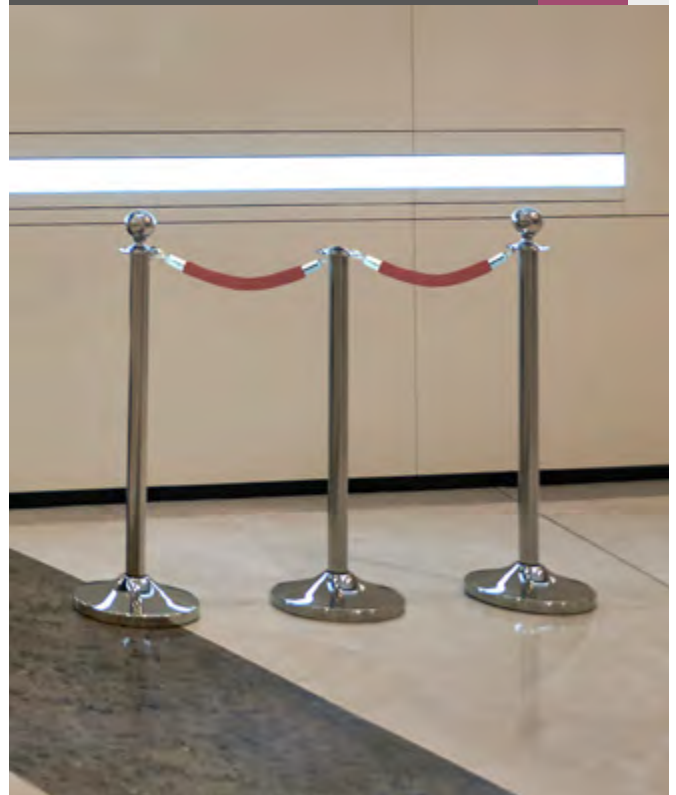

STANCHION DETAILS

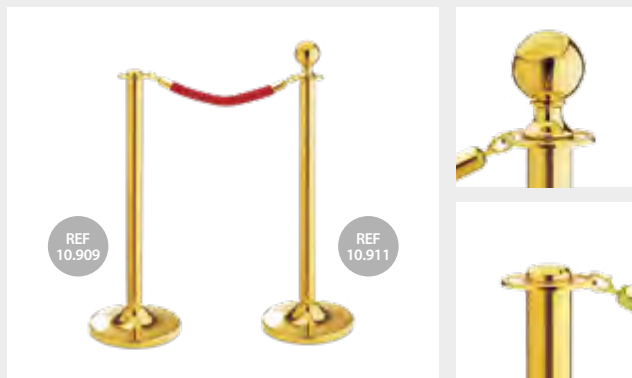

INFORMATION

This classic Stanchion features flat or ball top. It is constructed with sturdy, durable steel parts with polished golden finish. With a Ø50mm pole, a Ø320mm cement dome base which adds stability to the stanchion and a built-in 4-way ring holder. Ideal for higher traffic areas like theaters, lobbies, restaurants, airports or anywhere else you have the need to guide patrons.

DIMENSIONS *mm

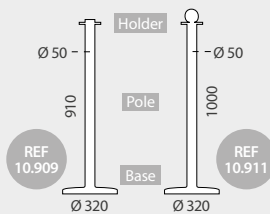

CLASSIC BRASS STANCHION

	POLE COLOR		Ø POLE	Ø BASE	HEIGHT	
10.909	Golden		50mm	320mm	910mm	x2 
10.911	Golden		50mm	320mm	1000mm	x2 

CLASSIC BRASS STANCHION FOR ROPES



* ropes at this page are available but not included

STANCHION DETAILS



INFORMATION

This classic Stanchion is 1300mm height. It is constructed with sturdy, durable steel parts with polished chrome or gold finish. It features a landscape format 420x320mm frame (with a 3mm thickness panel included) for displaying information signages. With a Ø50mm pole, a Ø320mm cement dome base which adds stability to the stanchion and a built-in 4-way ring holder. Ideal for theaters, lobbies, hotels, airports or anywhere else you need to show information or the schedule of the event.

DIMENSIONS *mm

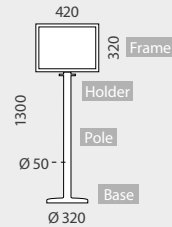

LANDSCAPE SIGN FRAME STANCHION

	POLE COLOR	Ø POLE	Ø BASE	HEIGHT	GRAPHIC SIZE	
10.914	Chrome 	50mm	320mm	1300mm	420x320mm	x2 
10.915	Golden 	50mm	320mm	1300mm	420x320mm	x2 

LANDSCAPE SIGN FRAME STANCHION



STANCHION DETAILS

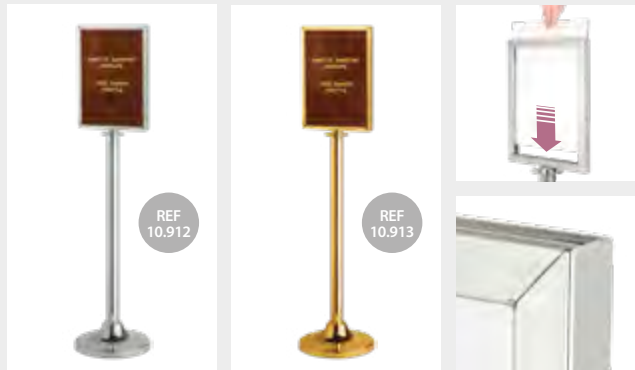

INFORMATION

This classic Stanchion is 1440mm height. It is constructed with sturdy, durable steel parts with polished chrome or gold finish. It features a portrait format 320x420mm frame (with a 3mm thickness panel included) for displaying information signages. With a Ø50mm pole, a Ø320mm cement dome base which adds stability to the stanchion and a built-in 4-way ring holder. Ideal for theaters, lobbies, hotels, airports or anywhere else you need to show information or the schedule of the event.

DIMENSIONS *mm

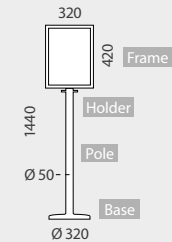

PORTRAIT SIGN FRAME STANCHION

	POLE COLOR	Ø POLE	Ø BASE	HEIGHT	GRAPHIC SIZE	
10.912	Chrome 	50mm	320mm	1440mm	320x420mm	x2 
10.913	Golden 	50mm	320mm	1440mm	320x420mm	x2 

PORTRAIT SIGN FRAME STANCHION



* ropes at this page are available but not included

ROPES DETAILS



VELOUR ROPES

	ROPE COLOR	END COLOR	LENGTH	Ø ROPE
10.919	2035C	Silver	1500mm	32mm
10.920	Black 6C	Silver	1500mm	32mm
13.760	281C	Silver	1500mm	32mm
10.921	2035C	Golden	1500mm	32mm
10.922	Black 6C	Golden	1500mm	32mm
13.761	281C	Golden	1500mm	32mm

VELOUR ROPES

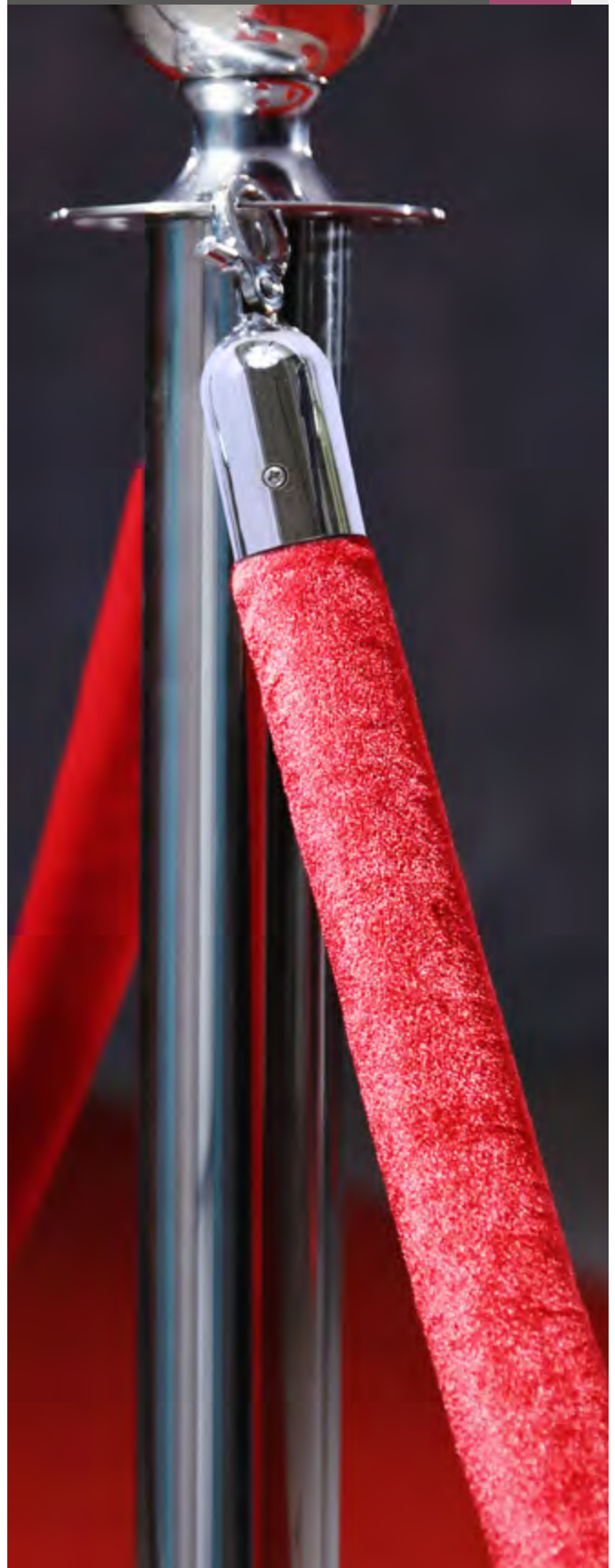

ROPES DETAILS



BRAIDED ROPES

	ROPE COLOR	END COLOR	LENGTH	Ø ROPE
10.923	294C		Silver	1500mm 32mm
10.977	WHITE		Silver	1500mm 32mm
13.762	198C		Silver	1500mm 32mm
13.764	BLACK		Silver	1500mm 32mm
13.766	WH+198C		Silver	1500mm 32mm
10.925	294C		Golden	1500mm 32mm
10.976	WHITE		Golden	1500mm 32mm
10.924	198C		Golden	1500mm 32mm
13.763	BLACK		Golden	1500mm 32mm
13.765	WH+198C		Golden	1500mm 32mm

BRAIDED ROPES



HANGERS DETAILS

INFORMATION

DIMENSIONS *mm



These metallic hangers for wall mounting are suitable for being used with ropes (screws are included) and they are ideal for being used at events, restaurants clubs, theaters or at airports.

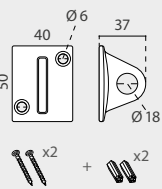

WALL HANGER FOR ROPES

	FINISH	SIZE
13.446	Silver	40x50x37mm
13.447	Golden	40x50x37mm

WALL HANGER FOR ROPES



BARS DETAILS



INFORMATION

*mm

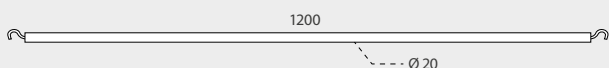

These Ø20mm tube bars for rope stanchions feature a chrome finish and have a total length of 1200mm. They are Ideal for supporting and displaying graphics.

CHROMED BARS

	COLOR		LENGTH	Ø TUBE
10.990	Chrome		1200mm	Ø 20mm

1200mm CHROMED BARS FOR STANCHIONS



RING DETAILS

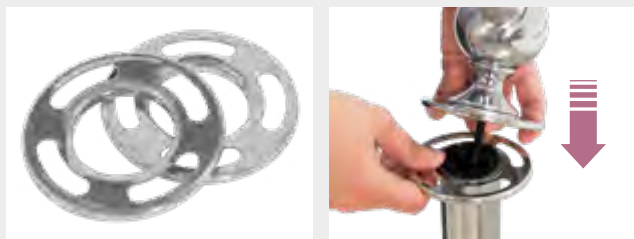

INFORMATION

DIMENSIONS

*mm

This Ø100mm Ring for rope stanchions is made of stainless steel with a chrome finish. With a 4-way design, this ring holder is ideal for being used with ropes at higher traffic areas like theaters, lobbies, restaurants or at the airport zones. Simple and fast to assemble.

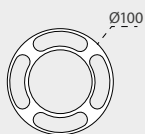

CHROMED RING

	COLOR		Ø RING
10.991	Chrome		100mm

Ø100mm CHROMED RING FOR STANCHIONS



* example with graphic (graphic and stanchions are available but not included).



Tents & Inflatables

05

Wide range of tents and inflatables which provide an integral solution for the exhibition at outdoor events or business presentations.

- 200 STEEL TENTS
- 203 ALUMINIUM TENT
- 204 TENT ACCESSORIES
- 205 INFLATABLES
- 210 BICYCLE STAND



TENT DETAILS



DIMENSIONS

*mm

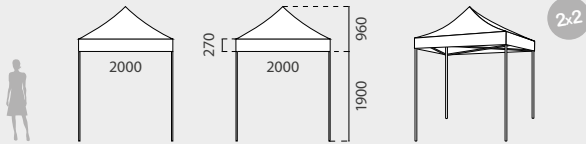

INFORMATION

This 2x2 portable tent features a steel truss frame and a cover top made of high quality, rugged fabric. Set Up is easy and quickly. Also, its adjustable legs allow to adjust the height of the tent. It is often seen at outdoor events, indoor trade shows, large-scale public events or family parties. Spikes, ropes and a travel case with wheels are included.

	QTY	N.W	G.W	C.B.M	SIZE
Packing	1	19kg	20kg	0.087	1680x230x230mm
10.181	<input type="checkbox"/>	PROFILE	30	2000x2000mm	
10.182	<input type="checkbox"/>				
10.183	<input type="checkbox"/>				

2x2 STEEL TENT



TENT DETAILS

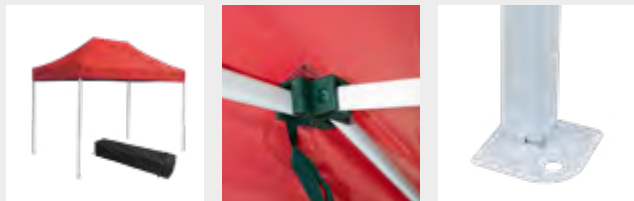

DIMENSIONS

*mm

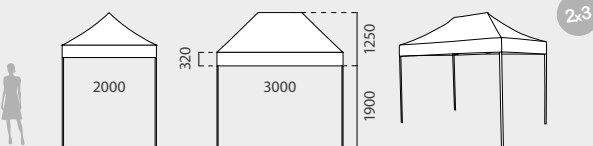

INFORMATION

This 2x3 portable tent features a steel truss frame and a cover top made of high quality, rugged fabric. Set Up is easy and quickly. Also, its adjustable legs allow to adjust the height of the tent. It is ideal at any outdoor event like promotional public acts or private celebrations. Spikes, ropes and a travel case with wheels are included.

	QTY	N.W	G.W	C.B.M	SIZE
Packing	1	23.5kg	24.5kg	0.126	1680x230x330mm
10.184	<input type="checkbox"/>	PROFILE	30	2000x3000mm	
10.185	<input type="checkbox"/>				
10.186	<input type="checkbox"/>				

2x3 STEEL TENT



* flag banner and counter are not included

TENT DETAILS



DIMENSIONS

*mm

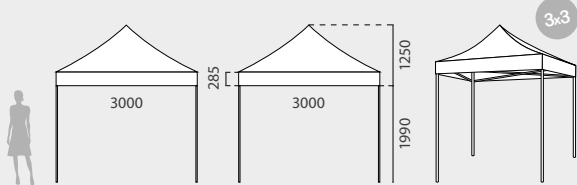

INFORMATION

This 3x3 portable tent features a steel stable truss frame and a cover top made of high quality, rugged fabric available in 3 colors (Royal blue, White or Red). This pop up tent provides shade, shelter, and advertising space at promotional events. Have an instant shade option in seconds after quickly raising the frame and clicking it into position with its spring-loaded locks (no Tools Required). Also, thanks to its adjustable legs, you can adjust the height of the tent (3 different height settings). Ground spikes and ropes are included in the package to be used in case of light winds at outdoor events. Also, for a simple and fast transportation, a travel case with wheels is included. It is often seen at any event, like indoor trade shows, large-scale public events, flea markets, outdoor parties, concerts, festivals or a family party.

QTY N.W G.W C.B.M SIZE

Packing 1 24kg 26kg 0.09 1680x230x240mm

10.187 PROFILE
 10.188 
 10.189 

 30

3000x3000mm

3x3 STEEL TENT



TENT DETAILS



DIMENSIONS

*mm

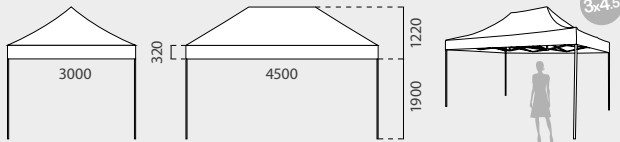

INFORMATION

This 3x4.5 portable tent features a steel truss frame and a cover top made of high quality, rugged fabric. Set Up is easy and quickly. Also, its adjustable legs allow to adjust the height of the tent. It is often seen at outdoor events, indoor trade shows, large-scale public events or family parties. Spikes, ropes and a travel case with wheels are included.

	QTY	N.W	G.W	C.B.M	SIZE
Packing	1	31kg	33kg	0.13	1680x320x250mm
10.190	<input type="checkbox"/>	PROFILE  30	3000x4500mm		
10.220	<input checked="" type="checkbox"/>				
10.250	<input checked="" type="checkbox"/>				

3x4.5 STEEL TENT



Blackboard
ref 14.112

+info at
chap 2

TENT DETAILS

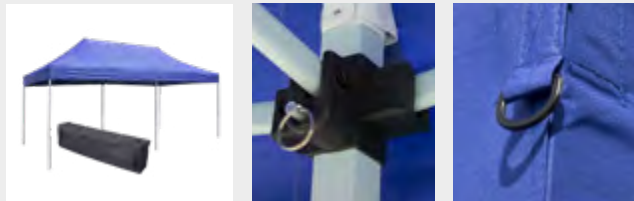

DIMENSIONS

*mm

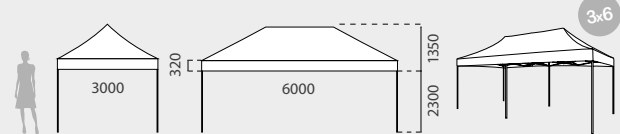

INFORMATION

This 3x6 portable tent has the biggest size available, featuring a steel truss frame and a cover top made of high quality, rugged fabric. Set Up is easy and quickly. Also, its adjustable legs allow to adjust the height of the tent. It is often seen at outdoor events, indoor trade shows, large-scale public events or family parties. Spikes, ropes and a travel case with wheels are included.

	QTY	N.W	G.W	C.B.M	SIZE
Packing	1	43.5kg	44.5kg	0.173	1680x420x250mm
10.251	<input type="checkbox"/>	PROFILE  30	2000x3000mm		
10.252	<input checked="" type="checkbox"/>				
10.253	<input checked="" type="checkbox"/>				

3x6 STEEL TENT



Flag
ref 13.893

+info at
chap 3

TENT DETAILS



WALL OPTIONS

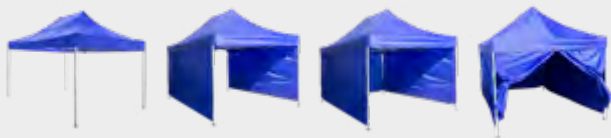

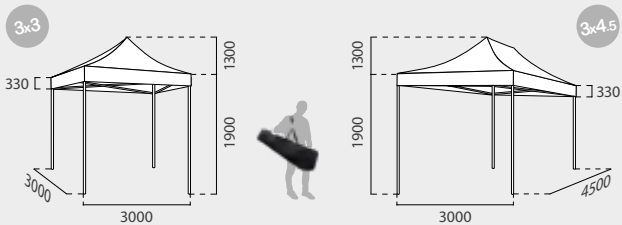

DIMENSIONS

*mm



INFORMATION

This portable tent features an aluminium truss frame and a cover top made of high quality blue fabric. Have an instant shade option in seconds after quickly raising the frame and clicking it into position with its spring-loaded locks. Also, featuring height adjustable legs and 4 walls to customize tent with various configurations. Ideal for outdoor events, trade shows, outdoor markets, public events or a family party. Spikes, ropes and a travel case with wheels are included.

	PROFILE	QTY	N.W	G.W	C.B.M	SIZE
10.433		1	16.5kg	17.5kg	0.087	1630x250x260mm
			3000x3000mm			
10.434		1	21kg	22.8kg	0.096	1630x350x260mm
			3000x4500mm			

ALUMINIUM TENT



BASE DETAILS



INFORMATION

*mm

This square black steel base is suitable for being used with the tents of this chapter, thanks to its design is suitable for placing together to the profiles, also it is stackable for a better storage and it has an ergonomic handle space for an easy transport with one hand. This base weighs 7kg.

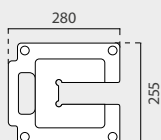

TENT BASE	QTY	N.W	G.W	C.B.M	SIZE
Packing	1	7kg	7.5kg	0.002	200x200x50mm
15.262		280x255mm		x2 	

TENT BASE 7kg



BASE DETAILS



INFORMATION

*mm

This round black steel base is ideal for being used with the tents of this catalogue, thanks to its design is suitable for placing together to the profiles and it is stackable for a better storage. Also it has 2 spaces for fixing to the ground and an ergonomic handle space for an easy transport with one hand. It weighs 10kg.

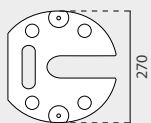

TENT BASE	QTY	N.W	G.W	C.B.M	SIZE
Packing	1	10kg	10.5kg	0.002	200x200x50mm
10.254			Ø 270mm		

TENT BASE 10kg



GATE DETAILS



DIMENSIONS

*mm

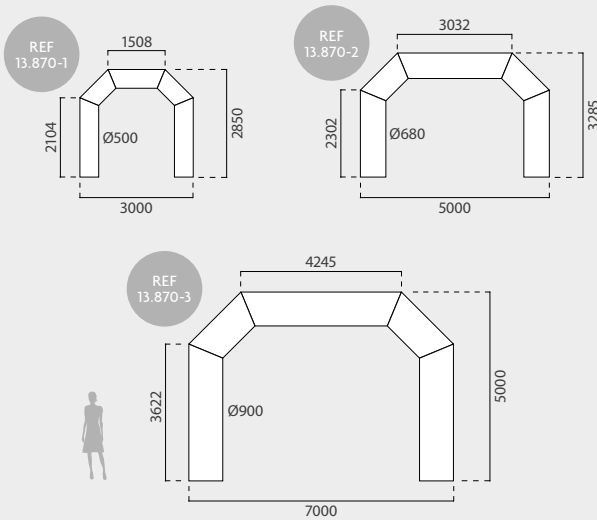

INFORMATION

It has better weather resistance, better stability, no collapse risk and no blower noise than others. Also, it doesn't need electrical fan motor which pumps air continuously, thanks to its separate inflate and deflate nozzles, it just needs a few minutes to this task. Moreover, offers big space for branding. Before customizing, remove the TPU inner sleeve. The advantages of these inflatable arches are the compactness for transportation and easy installation. Ideal for sport events, opening of stores or private parties.

GATE 3000	QTY	N.W	G.W	C.B.M	SIZE
Packing	1	14kg	15.5kg	0.069	570x210x570mm
13.870-1	<input type="checkbox"/>	3000mm			
GATE 5000	QTY	N.W	G.W	C.B.M	SIZE
Packing	1	23kg	24kg	0.169	780x300x720mm
13.870-2	<input type="checkbox"/>	5000mm			
GATE 7000	QTY	N.W	G.W	C.B.M	SIZE
Packing	1	27kg	28kg	0.288	910x310x1020mm
13.870-3	<input type="checkbox"/>	7000mm			

INFLATABLE GATE



* the textile printing is not included in the price but it is available under request.

COLUMN DETAILS



DIMENSIONS

ARTWORK

*mm

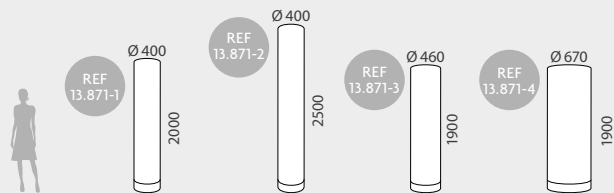

INFORMATION

The Inflatable Column doesn't need electrical fan motor which pumps air continuously, thanks to its separate inflate and deflate nozzles just needs a few minutes to this task. Base with 4 rings for fixing to the floor. Interior or exterior use. You can customize it with your own graphic (printing available but not included). Before customizing, remove the TPU inner sleeve.

COLUMN 1	QTY	N.W	G.W	C.B.M	SIZE
Packing	1	6kg	7kg	0.031	150x440x470mm
13.871-1	<input type="checkbox"/>	Ø400x2000mm			
COLUMN 2	QTY	N.W	G.W	C.B.M	SIZE
Packing	1	7kg	8kg	0.031	150x440x470mm
13.871-2	<input type="checkbox"/>	Ø400x2500mm			
COLUMN 3	QTY	N.W	G.W	C.B.M	SIZE
Packing	1	8kg	9kg	0.037	150x500x500mm
13.871-3	<input type="checkbox"/>	Ø460x1900mm			
COLUMN 4	QTY	N.W	G.W	C.B.M	SIZE
Packing	1	13kg	14kg	0.096	700x200x690mm
13.871-4	<input type="checkbox"/>	Ø670x1900mm			

MANUAL PUMP

PUMP DETAILS

INFORMATION

*mm



Economic air pump for inflatable gates and columns. The air pump tube length is 1000mm. This pump has two separate ducts for inflation and deflation. Also, features various mouthpiece diameters.

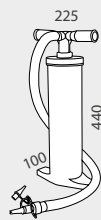

MAN. PUMP	QTY	N.W	G.W	C.B.M	SIZE
Packing	1	0.78kg	1kg	0.0115	455x230x110mm
13.872		225x440x1000mm			

INFLATABLE COLUMN



ELECTRIC PUMP

PUMP DETAILS

INFORMATION

*mm



Electric air pump to inflate gates and columns effortlessly. The air pump tube length is 1000mm. Also, features various mouthpiece diameters. The length of the power cable is 1700mm

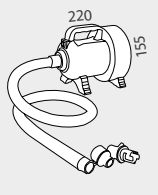

ELECT. PUMP	QTY	N.W	G.W	C.B.M	SIZE
Packing	1	1.33kg	1.5kg	0.0075	230x180x180mm
13.873		220x155x155mm			

* the textile printing is not included in the price but it is available under request.

DANCER DETAILS



INFORMATION

*mm

The inflatable air dancer is 6m high and features two colors. It is lightweight and easy to handle. A carry bag is included for an easy and fast transport. Ideal to achieve great visual impact thanks to its constant motion. Featuring an electrical fan motor which pumps air continuously. The Air Dancer is designed to help increase the visibility of your establishment, highlight promotions and public campaigns, increase foot traffic and help to promote any special event.

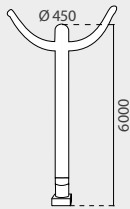

SIZE

15.152	<input checked="" type="checkbox"/>	Ø 450x6000mm
15.154	<input type="checkbox"/>	

AIR DANCER



6m



TENT DETAILS

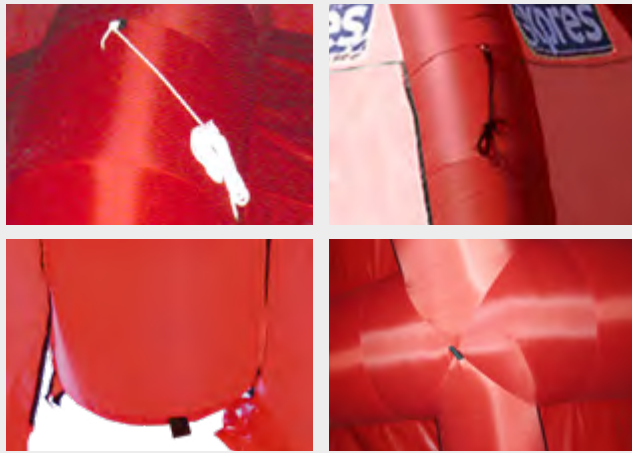

DIMENSIONS

*mm

2.9m high

supplied with accessories

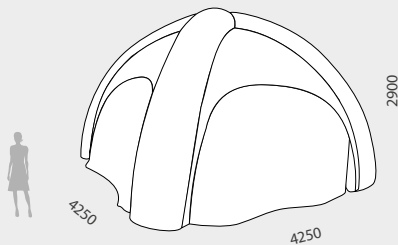

INFORMATION

This inflatable Tent with removable sides includes an air motor and features advertising customized publicity spaces at fronts. It is supplied with accessories. Fast and easy to assemble. This inflatable tent/dome features 4 removal walls thanks to its sides zippers. With 2 colors available (white or red) and a transport bag included for an easy transport. Ideal for promotional events at squares, sports arenas, playing centers, festivals or just for family parties at gardens or parks.

SIZE

15.158	<input type="checkbox"/>	4250x4250x2900mm
15.159	<input checked="" type="checkbox"/>	

INFLATABLE TENT



Golf Banner
ref 13.915

Flag
ref 13.607

* the textile printing is not included in the price but it is available under request.

TENT DETAILS

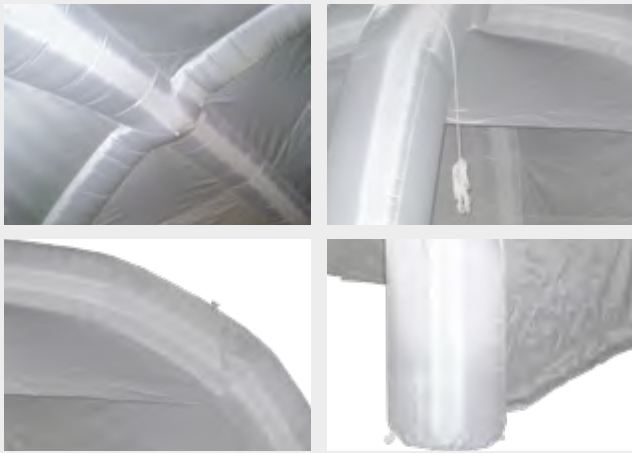

DIMENSIONS

*mm

2.9m high

supplied with several accessories

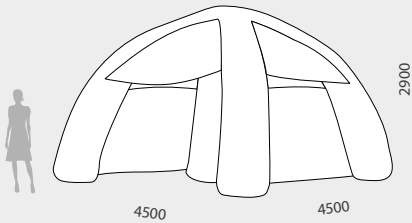

INFORMATION

This inflatable Auditorium includes an air motor and features advertising customized publicity spaces at fronts. It is supplied with accessories. Fast and easy to assemble. This inflatable tent/dome features 4 removal walls thanks to its sides zippers. With 2 colors available (white or red) and a transport bag included for an easy transport. Ideal for promotional events at squares, sports arenas, playing centers, festivals or just for family parties at gardens or parks.

SIZE

15.169



4500x4500x2900mm

INFLATABLE AUDITORIUM TENT



Flag ref 13.603



Flag ref 10.031

* the textile printing is not included in the price but it is available under request.

STAND DETAILS

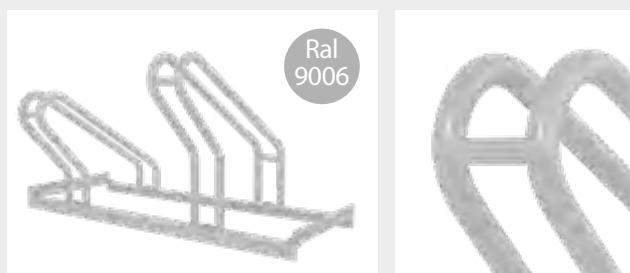



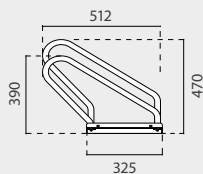

INFORMATION

*mm

Carlow Bike Support is made of steel with a galvanized finish on RAL 9006 Grey, so it is weatherproof and resistant to the corrosion. Featuring 5 sizes available, and designed for 2-7 bike. Ideal for outdoor expositions, mall entrances or retail stores.



CARLOW	LENGTH	PLACES	
10.705	700mm	2 Places	
10.706	1050mm	3 Places	
10.762	1750mm	5 Places	
10.782	2100mm	6 Places	
10.933	2450mm	7 Places	

CARLOW



STAND DETAILS



INFORMATION

*mm

Wexford Bike Support is made of steel with a galvanized finish on RAL 9006 Grey, so it is weatherproof and resistant to the corrosion. Featuring a double-sided frame. It is designed for a maximum of 6 bikes. Wexford Bike Support is ideal for outdoor expositions, mall entrances or retail stores.

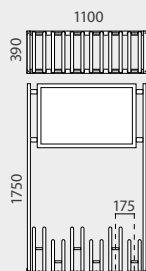

WEXFORD	GRAPHIC SIZE	PLACES
10.809	A1 (594x841mm)	6 Places

WEXFORD



Frames & Info Holders

06

A complete range of frames and info holders which provide an integral solution for the exhibition at promotional events, stores or business presentations.

212	CLICK FRAMES
223	SLIDE-IN FRAMES
224	FRAME FOR BOARDS
225	CLICK LED FRAMES
229	TABLET STANDS
238	LECTERN STANDS
244	CLICK STANDS
253	INFO TOTEMS
262	LITERATURE STANDS
274	BROCHURE HOLDERS
289	BALLOT BOXES



FRAME DETAILS



INFORMATION

* W: Width H: Height D: Depth *mm

click

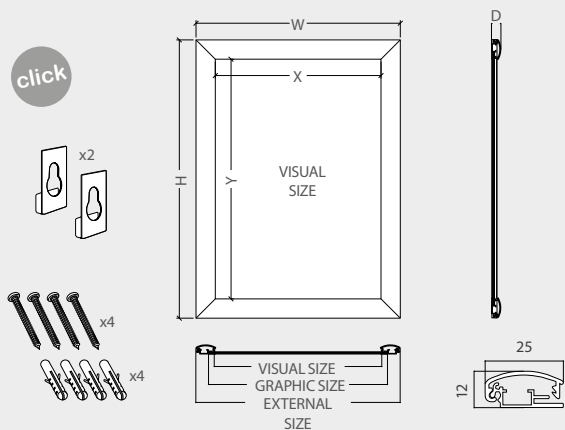



The Maracay frame is economically priced because the profile is thinner and lightweight than other frames. Once this display is wall mounted though there is virtually no difference. Perfect for restaurants, retail stores, community centers, theatres, airports, supermarkets. Antireflection protector and screws included.

MARACAY





MARACAY A4 W: Width H: Height D: Depth *mm

	QTY	N.W	G.W	C.B.M	Size (WxHxD)
Packing	10	0.4kg	5.1kg	0.0205	355x210x275
		Visual (X-Y)	External (WxHxD)		
Product		196x282	246x332x13		

14.124   Graphic Size: A4



MARACAY A3 W: Width H: Height D: Depth *mm

	QTY	N.W	G.W	C.B.M	Size (WxHxD)
Packing	10	0.57kg	8.2kg	0.0363	480x210x360
		Visual (X-Y)	External (WxHxD)		
Product		284x409	334x507x13		

14.123   Graphic Size: A3



MARACAY A2 W: Width H: Height D: Depth *mm

	QTY	N.W	G.W	C.B.M	Size (WxHxD)
Packing	10	0.91kg	13.2kg	0.0672	660x210x485
		Visual (X-Y)	External (WxHxD)		
Product		406x587	456x637x13		

14.122   Graphic Size: A2



MARACAY A1 W: Width H: Height D: Depth *mm

	QTY	N.W	G.W	C.B.M	Size (WxHxD)
Packing	5	1.5kg	11.7kg	0.0726	910x120x665
		Visual (X-Y)	External (WxHxD)		
Product		587x838	637x888x13		

14.121   Graphic Size: A1



MARACAY H700 W: Width H: Height D: Depth *mm

	QTY	N.W	G.W	C.B.M	Size (WxHxD)
Packing	10	1.22kg	14.7kg	0.0910	760x210x570
		Visual (X-Y)	External (WxHxD)		
Product		488x694	538x744x13		

14.126   Graphic: 500x700mm

MARACAY H1000 W: Width H: Height D: Depth *mm

	QTY	N.W	G.W	C.B.M	Size (WxHxD)
Packing	5	1.7kg	12.9kg	0.0979	1060x120x770
		Visual (X-Y)	External (WxHxD)		
Product		693x986	743x1036x13		

14.125   Graphic: 700x1000mm

FRAME DETAILS



ANADIA



INFORMATION

* W: Width H: Height D: Depth *mm

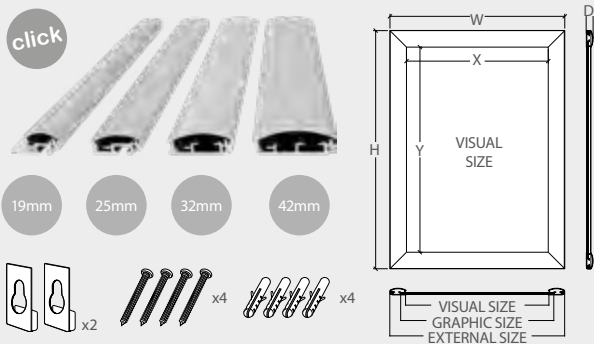



Anadia frame is constructed from anodized aluminum with matte silver finish. It features Click spring-loaded action, so updating a presentation takes a few seconds. Includes antireflection protector, screws and hangers for wall mounting. This frame is perfect for restaurants, retail stores, theatres, airports, malls, banks or for any other location requiring a frequent change of the graphics.

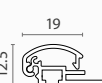
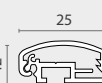

ANADIA

* W: Width H: Height D: Depth *mm

Ref.	Graphic Size	Visual (X-Y)	External (WxHxD)	Profile	Packing (QTY)	N.W	G.W	C.B.M	Size (WxHxD)
10.314	A4	199x286	237x324x12.50		1	0.4kg	0.5kg	0.024	270x350x25
10.315	A3	286x409	324x477x12.50		1	0.7kg	0.85kg	0.0061	365x480x35
10.316	A2	409x583	447x621x12.50		1	1kg	1.3kg	0.0067	475x645x22
10.317	500x700	489x689	527x727x12.50		1	1.3kg	1.7kg	0.0104	560x745x25
10.214	A4	190x278	242x329x12		1	0.45kg	0.55kg	0.0024	270x350x25
10.213	A3	278x401	329x452x12		1	0.65kg	0.85kg	0.0061	365x480x35
10.212	A2	401x575	452x626x12		1	1.05kg	1.35kg	0.0067	475x645x22
10.215	500x700	480x680	532x732x12		1	1.4kg	1.8kg	0.0104	560x745x25
10.290	A3	275x398	339x462x13.3		1	0.8kg	1.05kg	0.0061	365x480x35
10.291	A2	398x572	462x636x13.3		1	1.2kg	1.6kg	0.0067	475x645x22
10.292	A1	572x819	663x884x13.3		1	2kg	2.45kg	0.0143	645x886x25
10.293	500x700	478x678	542x742x13.3		1	1.5kg	2kg	0.0104	560x745x25
10.294	700x1000	678x978	742x1042x13.3	1	2.55kg	3.25kg	0.0197	1075x780x25	
10.296	A0	821x1169	905x1253x14.5		1	4kg	5.04kg	0.0291	1265x920x25
10.295	700x1000	680x980	764x1064x14.5		1	3kg	3.75kg	0.0197	1075x780x25
10.297	1000x1400	980x1380	1064x1464x14.5		1	5.55kg	6.7kg	0.0398	1475x1080x25

FRAME DETAILS



ANADIA
DOUBLE-SIDED



INFORMATION

* W: Width H: Height D: Depth

click



42mm

32mm

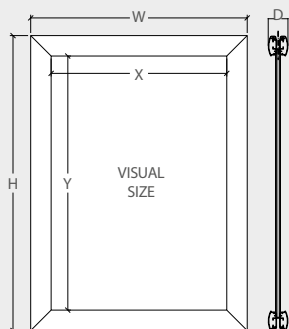



The Double-sided Anadia frame is constructed from aluminum with matte silver finish. It can be mounted vertically or horizontally, depending on your sign or advertisement. This frame includes antireflection protector and the necessary screws and hangers for hanging. Insert your posters or graphics on top of the back panel, replace the protector and flip the sides down. This frame features 2 ways visibility, increasing advertisement exposure. Ideal for hanging in a storefront window or from the ceiling allow for placement overhead, in a central location.

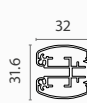

ANADIA DOUBLE-SIDED

* W: Width H: Height D: Depth *mm

Ref.	Graphic Size	Visual (X-Y)	External (WxHxD)	Profile	Packing (QTY)	N.W	G.W	C.B.M	Size (WxHxD)
10.299	A3	283x406	347x470x31.6		1	1.25kg	1.6kg	0.0061	480x365x35
10.300	A2	406x580	470x664x31.6		1	1.85kg	2.15kg	0.0127	485x655x40
10.302	A1	580x827	644x891x31.6		1	2.8kg	3.25kg	0.0235	660x890x40
10.303	500x700	486x686	550x750x31.6		1	2.3kg	2.8kg	0.0172	565x760x40
10.562	A0	807x1155	891x1239x33.9		1	4.7kg	6.2kg	0.0430	905x1250x38
10.566	700x1000	666x966	750x1050x33.9		1	4kg	4.85kg	0.0323	765x1055x40

FRAME DETAILS



LIMA



INFORMATION

* W: Width H: Height D: Depth

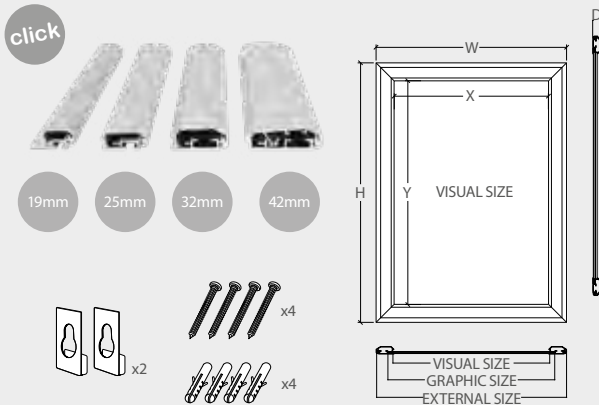



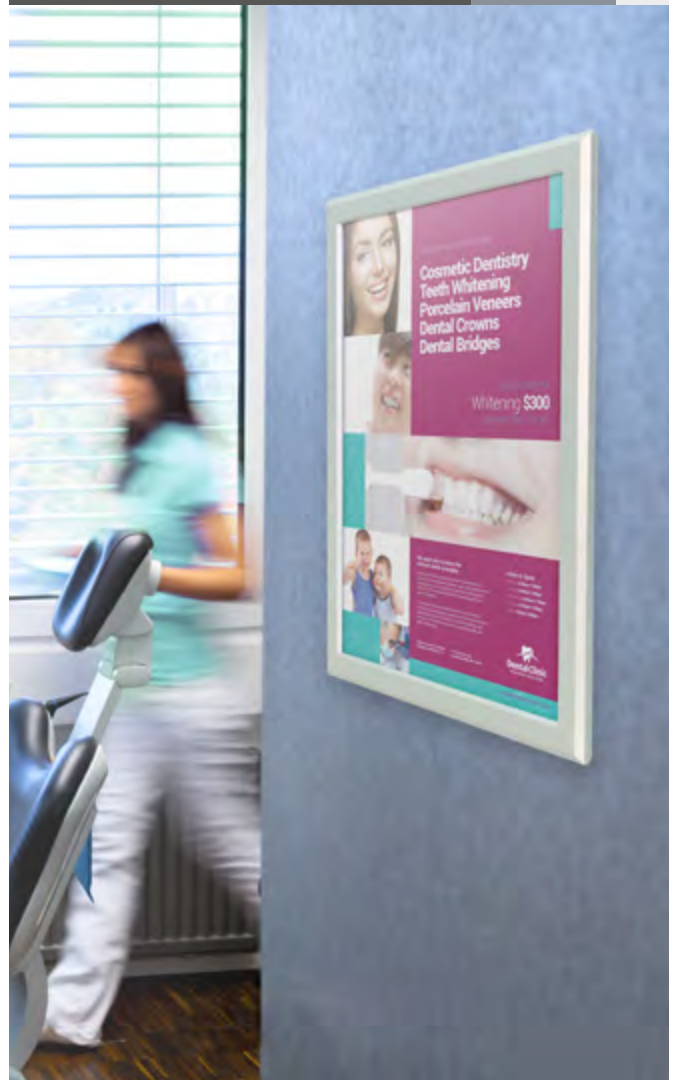













The Lima frame is constructed from anodized aluminum with a matte silver finish. It features Click spring-loaded action, so updating a presentation takes only a few seconds. It can be mounted vertically or horizontally and includes antireflection protector, screws and hangers for wall mounting. This frame is perfect for restaurants, retail stores, movie theatres, airports, malls, banks or for any other location requiring a frequent change of the graphics.



LIMA

* W: Width H: Height D: Depth *mm

Ref.	Graphic Size	Visual (X-Y)	External (WxHxD)	Profile	Packing (QTY)	N.W	G.W	C.B.M	Size (WxHxD)
10.210	A4	199x286	237x324x11.95		1	0.4kg	0.5kg	0.0024	270x350x25
10.209	A3	286x409	324x477x11.95		1	0.7kg	0.85kg	0.0061	365x480x35
10.208	A2	409x583	447x621x11.95		1	1kg	1.3kg	0.0067	475x645x22
10.211	500x700	489x689	527x727x11.95		1	1.3kg	1.7kg	0.0104	560x745x25
10.260	A4	190x278	242x329x11.5		1	0.45kg	0.55kg	0.0024	270x350x25
10.259	A3	278x401	329x452x11.5		1	0.65kg	0.85kg	0.0061	365x480x35
10.258	A2	401x575	452x626x11.5		1	1.05kg	1.35kg	0.0067	475x645x22
10.261	500x700	480x680	532x732x11.5		1	1.4kg	1.8kg	0.0104	560x745x25
10.262	A3	275x398	339x462x13.75		1	0.8kg	1.05kg	0.0061	365x480x35
10.263	A2	398x572	462x636x13.75		1	1.2kg	1.6kg	0.0067	475x645x22
10.264	A1	572x819	663x884x13.75		1	2kg	2.45kg	0.0143	645x886x25
10.266	500x700	478x678	542x742x13.75		1	1.5kg	2kg	0.0104	560x745x25
10.267	700x1000	678x978	742x1042x13.75		1	2.6kg	3.5kg	0.0197	1075x780x25
10.270	A0	821x1169	905x1253x13.75		1	4kg	5.04kg	0.0291	1265x920x25
10.272	700x1000	680x980	764x1064x13.75		1	3kg	3.75kg	0.0197	1075x780x25
10.268	1000x1400	980x1380	1064x1464x13.75		1	5.5kg	6.7kg	0.0398	1475x1080x25

FRAME DETAILS



LIMA
DOUBLE-SIDED



INFORMATION

* W: Width H: Height D: Depth

click



32mm

42mm

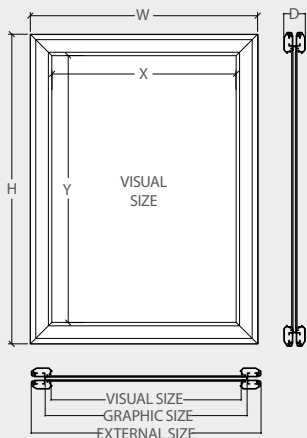
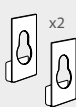



The Double-sided Lima frame is constructed from aluminum with matte silver finish. It can be mounted vertically or horizontally, depending on your sign or advertisement. It includes antireflection protector and the necessary screws and hangers for hanging. Insert your posters or graphics on top of the back panel, replace the protector and flip the sides down. This frame features 2 ways visibility, increasing advertisement exposure. Ideal for hanging in a storefront window or from the ceiling allow for placement overhead, in a central location.

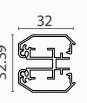

LIMA DOUBLE-SIDED

* W: Width H: Height D: Depth *mm

Ref.	Graphic Size	Visual (X-Y)	External (WxHxD)	Profile	Packing (QTY)	N.W	G.W	C.B.M	Size (WxHxD)
10.563	A3	283x406	347x470x32.39		1	1.25kg	1.6kg	0.0061	480x365x35
10.564	A2	406x580	470x664x32.39		1	1.85kg	2.15kg	0.0127	485x655x40
10.565	A1	580x827	644x891x32.39		1	2.8kg	3.25kg	0.0235	660x890x40
10.289	500x700	486x686	550x750x32.39		1	2.3kg	2.8kg	0.0172	565x760x40
10.257	A0	807x1155	891x1239x32.39		1	4.7kg	6.2kg	0.0430	905x1250x38
10.560	700x1000	666x966	750x1050x32.39		1	4kg	4.85kg	0.0323	765x1055x40

FRAME DETAILS



INFORMATION

* W: Width H: Height D: Depth

click



42mm

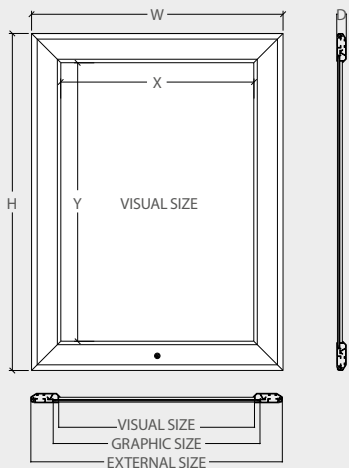
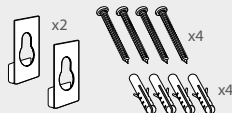

The Lima frame is constructed from anodized aluminum with matte silver finish and features a front-loading frame which can be secured shut with an Allen key to keep posters protected. It can be mounted vertically or horizontally. Antireflection protector, screws and allen key wrench included. This frame is perfect for being used in restaurants, retail stores, theatres, airports, banks or any other location requiring frequent changes of advertisements.

LIMA
LOCKABLE

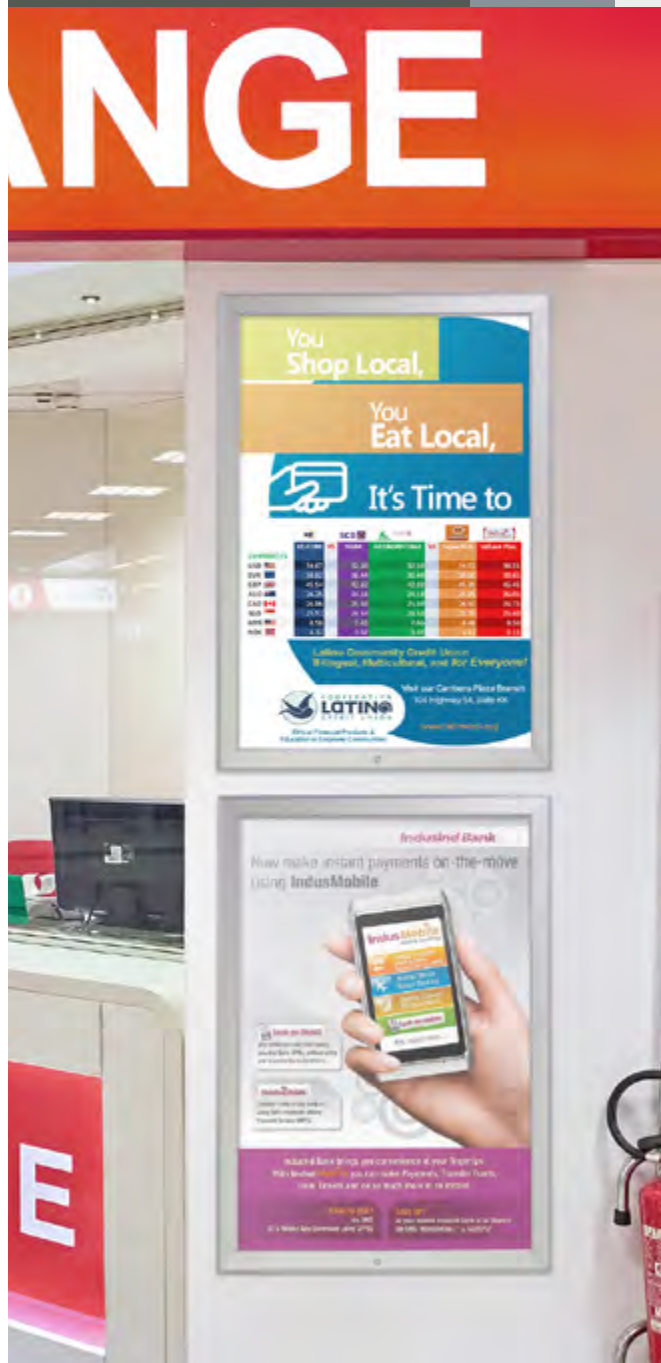

LIMA LOCKABLE

* W: Width H: Height D: Depth *mm

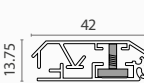
Ref.	Graphic Size	Visual (X-Y)	External (WxHxD)	Profile	Packing (QTY)	N.W	G.W	C.B.M	Size (WxHxD)
10.280	A1	574x821	658x905x13.75		1	2.3kg	2.85kg	0.0153	915x670x25
10.281	A0	821x1169	905x1253x13.75		1	4kg	5.04kg	0.0291	1265x920x65
10.282	500x700	480x680	564x764x13.75		1	1.8kg	2.35kg	0.0112	580x771x25
10.283	700x1000	680x980	764x1064x13.75		1	3kg	3.75kg	0.0191	1075x780x25
10.278	1000x1400	980x1380	1064x1464x13.75		1	5.55kg	6.7kg	0.0398	1475x1080x25

FRAME DETAILS



INFORMATION

* W: Width H: Height D: Depth

click



42mm

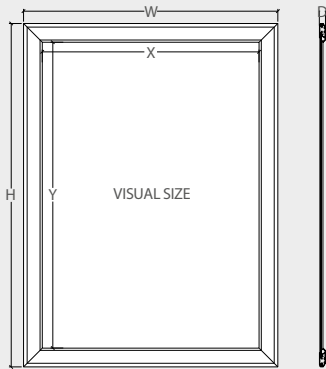
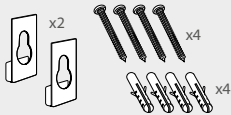

This Lima frame is constructed from anodized durable aluminum with a matte silver finish. It is waterproof, rust proof and it includes antireflection protector overlay to prevent glare. Screws and hangers are included. This frame is perfect for being used in restaurants, retail stores, community centers, movie theatres, airports, banks or any other outdoor location requiring frequent changes of advertisements.

LIMA
WATERPROOF



LIMA WATERPROOF

* W: Width H: Height D: Depth *mm

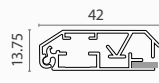
Ref.	Graphic Size	Visual (X-Y)	External (WxHxD)	Profile	Packing (QTY)	N.W	G.W	C.B.M	Size (WxHxD)
10.285	A1	580x827	664x911x13.75		1	2kg	2.5kg	0.0153	672x912x25
10.286	A0	827x1175	911x1259x13.75		1	4kg	5.04kg	0.0291	1265x920x25
10.287	500x700	486x686	570x770x13.75		1	1.65kg	2.01kg	0.0104	560x745x25
10.288	700x1000	686x986	770x1070x13.75		1	3.05kg	3.48kg	0.0191	1075x780x25
10.561	1000x1400	986x1386	1070x1470x13.75		1	5.55kg	6.7kg	0.0398	1475x1080x25

FRAME DETAILS



INFORMATION

* W: Width H: Height D: Depth *mm

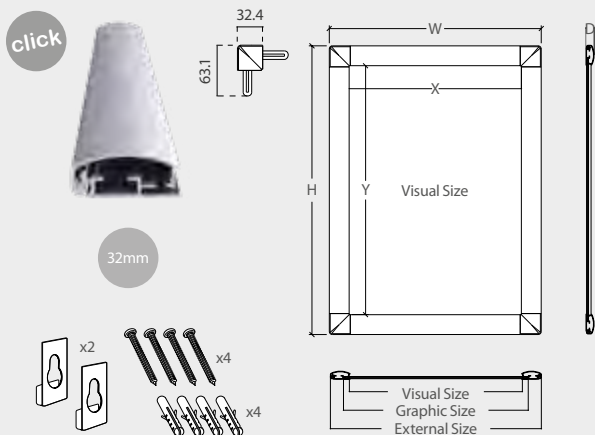

The Serena anodized aluminum frame features a stylish bicolor design. It has a 32mm width profile which features Click closing system. Graphics change takes only a few seconds. Antireflection protector, screws and hangers are included. Due to its elegant appearance the single-sided frame Serena is ideal for restaurants, hotels, theatres, offices, malls or any other location requiring a distinctive look on the frames or a frequent changes of posters.

SERENA



SERENA					* W: Width	H: Height	D: Depth	*mm	
Ref.	Graphic Size	Visual (X-Y)	External (WxHxD)	Profile	Packing (QTY)	N.W	G.W	C.B.M	Size (WxHxD)
10.405	A4	188x275	252x339x13.35		1	0.4kg	0.5kg	0.0024	270x25x350
10.404	A3	275x398	339x462x13.35		1	0.7kg	0.95kg	0.0042	475x22x355
10.403	A2	398x572	462x636x13.35		1	1.05kg	1.45kg	0.0067	475x22x645
10.408	500x700	478x678	542x742x13.35		1	1.35kg	1.85kg	0.0104	560x25x745
10.163	700x1000	678x978	742x1042x13.35		1	2.35kg	3.05kg	0.0197	1075x25x780

FRAME DETAILS



GET 6
CORNER
COLORS WITH
1 FRAME!

INCLUDES 4 GREY CORNERS AND 20 COLORED COVERS



INFORMATION

* W: Width H: Height D: Depth *mm

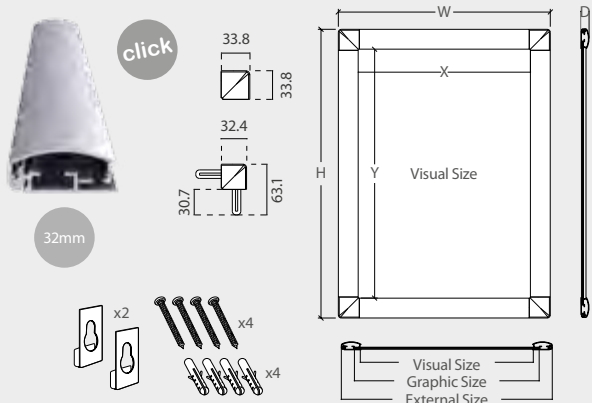

The Rainbow aluminum frame features 4 grey corners + 20 colored covers. It has a 32mm width profile which features click closing system. Insert your graphics on top of the back panel, replace the protector, and flip the sides down to hold everything in place, so updating a presentation takes only a few seconds. It can be mounted vertically or horizontally. Antireflection protector, screws and hangers are included. Featuring 5 standard sizes available. Due to its versatile design the single-sided frame Rainbow is ideal for restaurants, hotels, theatres, offices, malls or any other location requiring a distinctive look on the frames or a frequent changes of posters.

RAINBOW
FRAME



RAINBOW

* W: Width H: Height D: Depth *mm

Ref.	Graphic Size	Visual (X-Y)	External (WxHxD)	Profile	Packing (QTY)	N.W	G.W	C.B.M	Size (WxHxD)
13.590	A4	188x275	252x339x13.35		1	0.4kg	0.5kg	0.0024	270x25x350
13.591	A3	275x398	339x462x13.35		1	0.7kg	0.95kg	0.0042	475x22x355
13.592	A2	398x572	462x636x13.35		1	1.05kg	1.45kg	0.0067	475x22x645
13.593	500x700	478x678	542x742x13.35		1	1.35kg	1.85kg	0.0104	560x25x745
13.754	700x1000	678x978	742x1042x13.35		1	2.35kg	3.05kg	0.0197	1075x25x780

FRAME DETAILS



DIMENSIONS

* W: Width H: Height D: Depth

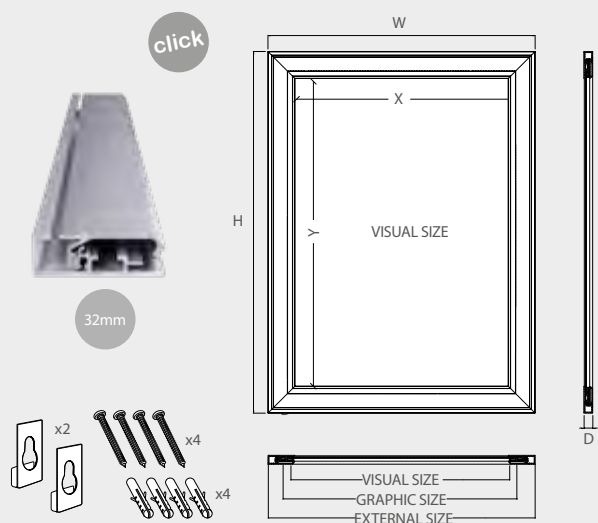

INFORMATION

The Iscar aluminum frame features a stylish design with double-framed appearance. It has a 34.9mm width profile which features click closing system so updating a presentation takes only a few seconds. It can be mounted vertically or horizontally. Antireflection protector, screws and hangers are included. Featuring 5 standard sizes available. Due to its elegant appearance the double-sided frame Iscar is ideal for restaurants, hotels, theatres, offices, malls or any other location requiring a distinctive look on the frames or a frequent changes of posters.

ISCAR
COVER FRAME



ISCAR

* W: Width H: Height D: Depth *mm

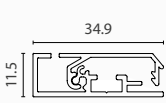
Ref.	Graphic Size	Visual (X-Y)	External (WxHxD)	Profile	Packing (QTY)	N.W	G.W	C. B.M	Size (WxHxD)
13.635	A3	278.2x401	346x471x11.5		1	1.04kg	1.19kg	0.0044	485x365x25
13.636	A2	401x575	471x645x11.5		1	1.52kg	1.78kg	0.0080	660x485x25
13.637	A1	575x822	645x892x11.5		1	2.34kg	2.78kg	0.0149	905x660x25
13.638	500x700mm	461x681	551x751x11.5		1	1.87kg	2.20kg	0.0108	765x565x25
13.639	700x1000mm	681x981	751x1051x11.5		1	2.95kg	3.54kg	0.0204	1065x765x25

FRAME DETAILS



ADDITIONAL COLORS UPON REQUEST

The Trujillo aluminum Click frame is available in more colors upon request*.



RAL 5005

RAL 3020

RAL 6029

WOOD COLOR

INFORMATION

* W: Width H: Height D: Depth *mm

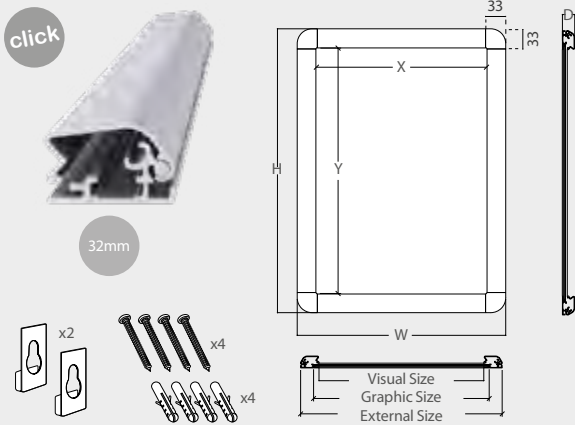

Trujillo aluminum frame features stylish bicolor design with rounded corners. Can be mounted vertically or horizontally. Antireflection protector, screws and hangers included. 4 colors available upon request. Ideal for restaurants, markets, malls or any other location requiring frequent changes of posters that takes only a few seconds.

TRUJILLO



TRUJILLO

* W: Width H: Height D: Depth *mm

Ref.	Graphic Size	Visual (X-Y)	External (WxHxD)	Profile	Packing (QTY)	N.W	G.W	C.B.M	Size (WxHxD)
10.130	A4	194x281	257x344x20.3		1	0.6kg	0.75	0.0039	360x275x40
10.131	A3	278x402	344x468x20.3		1	1kg	1.2kg	0.0061	365x480x35
10.132	A2	402x575	468x641x20.3		1	1.65kg	2.15kg	0.0127	485x655x40
10.133	A1	575x822	641x888x20.3		1	2.4kg	3.2kg	0.0235	660x890x40
10.134	A0	822x1170	888x1236x20.3		1	4.4kg	5.45kg	0.0430	1250x905x38
10.135	500x700	481x681	547x747x20.3		1	1.95kg	2.4kg	0.0104	560x745x25
10.136	700x1000	681x981	747x1047x20.3		1	3.25kg	4kg	0.0323	765x1055x40

FRAME DETAILS



DIMENSIONS

* W: Width H: Height D: Depth

Lublin aluminum frame has an open profile on one of its narrow sides. The change of graphic is really fast and easy, just insert your poster or graphic through the groove on the narrower side (W) of the Lublin frame, so this way, updating a presentation takes only a few seconds.

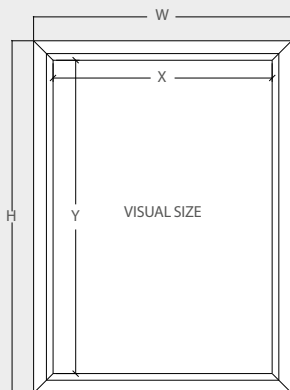

INFORMATION

Lublin frame is made of anodized aluminium. This aluminum is lightweight but durable and can be hung either vertically or horizontally as well. The antireflection protector prevents the graphics from tampering. Also, the screws and hangers for wall mounting are included. Lublin frame is ideal for restaurants, supermarkets, banks, movies theatres, airports, malls, offices, lobby, at home or any other location requiring frequent changes of posters.

LUBLIN



LUBLIN

* W: Width H: Height D: Depth *mm

Ref.	Graphic Size	Visual (X-Y)	External (WxHxD)	Profile	Packing (QTY)	N.W	G.W	C.B.M	Size (WxHxD)
10.594	A4	203x288	233x318x11		1	0.3kg	0.4kg	0.0020	325x245x25
10.593	A3	290x411	320x441x11		1	0.5kg	0.65kg	0.0037	450x332x25
10.588	A2	454x626	404x576x15		1	1kg	1.3kg	0.0074	633x466x25
10.587	A1	628x872	578x822x15		1	1.7kg	2.25kg	0.0135	880x640x24

FRAME DETAILS



DIMENSIONS

* W: Width H: Height D: Depth

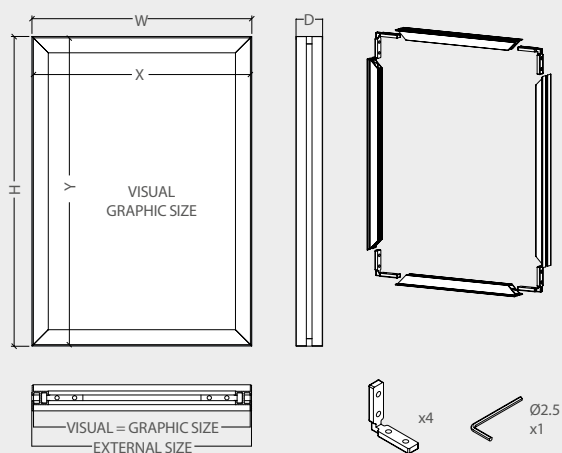

INFORMATION

* W: Width H: Height D: Depth















The Tarnow aluminum frame features a silver or a stunning black finished design for being used with foamboard graphics. It can be mounted vertically or horizontally and updating a poster is simple and fast. 7 standard sizes are available. Corner connections and Allen key are included. The maximum panel or foam thickness is 5mm. The Tarnow frame is ideal for restaurants, hotels, theatres, offices, malls or any other location requiring a distinctive look on the frames or a frequent changes of posters.

TARNOW



TARNOW

* W: Width H: Height D: Depth *mm

Ref.	Graphic Size	Visual (X-Y)	External (WxHxD)	Profile	Packing (QTY)	N.W	G.W	C.B.M	Size (WxHxD)
13.628	 	A4	297x210	213x300x25.3	1	0.34kg	0.42kg	0.0007	360x32x62
13.629	 	A3	420x297	300x423x25.3	1	0.45kg	0.58kg	0.0010	480x32x62
13.630	 	A2	594x420	423x597x25.3	1	0.59kg	0.82kg	0.0013	655x32x62
13.631	 	A1	841x594	597x844x25.3	1	0.80kg	1.21kg	0.0018	905x32x62
13.632	 	A0	1189x841	844x1192x25.3	1	1.10kg	1.89kg	0.0025	1250x32x62
13.633	 	500x700	500x700	503x703x25.3	1	0.69kg	1.01kg	0.0015	760x32x62
13.634	 	700x1000	700x1000	703x1003x25.3	1	0.93kg	1.5kg	0.0021	1060x32x62

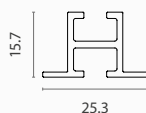

FRAME DETAILS



DIMENSIONS

* W: Width H: Height D: Depth * mm

click

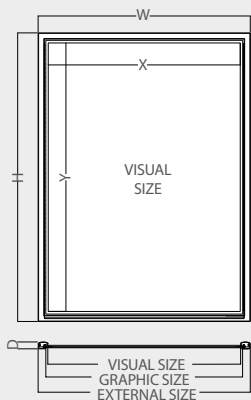
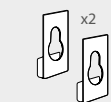

INFORMATION

This hanging light box for daily use combines the power of LED illumination technology with the elegance of a thin profile. The frame on each model is 17.8mm thick, making it one of the slimmest marketing devices currently available. The small LED bulbs in the sides of the window frame prevents against "hot" and "cold" spots appearing on the graphics. Yucatan Light Box comes with antireflection protector and is suitable for wall-mounting.

YUCATAN



YUCATAN

* W: Width H: Height D: Depth *mm

Ref.	Graphic Size	Visual (X-Y)	External (WxHxD)	Profile	Packing (QTY)	N.W	G.W	C.B.M	Size (WxHxD)
13.207	A0	828x1176	880x1228x17.8		1	7.25kg	10.1kg	0.0737	910x1350x60
13.208	A1	581x828	633x880x17.8		1	3.95kg	5.5kg	0.0398	660x1005x60
13.209	A2	407x581	459x633x17.8		1	2.1kg	3.1kg	0.0222	490x755x60
13.210	A3	284x407	336x459x17.8		1	1.3kg	1.95kg	0.0128	365x585x60
13.211	A4	197x284	249x336x17.8		1	0.8kg	1.2kg	0.0077	280x460x60
13.295	500x700	487x686	539x738x17.8		1	2.85kg	4.1kg	0.0296	570x865x60
13.296	700x1000	687x987	739x1039x17.8		1	5.3kg	7.3kg	0.0538	770x1165x60

* Other sizes available upon request / Autres dimension sur demande / Outros tamanhos disponíveis sob consulta / Otros tamaños disponibles bajo pedido.

FRAME DETAILS



DIMENSIONS

* W: Width H: Height D: Depth * mm

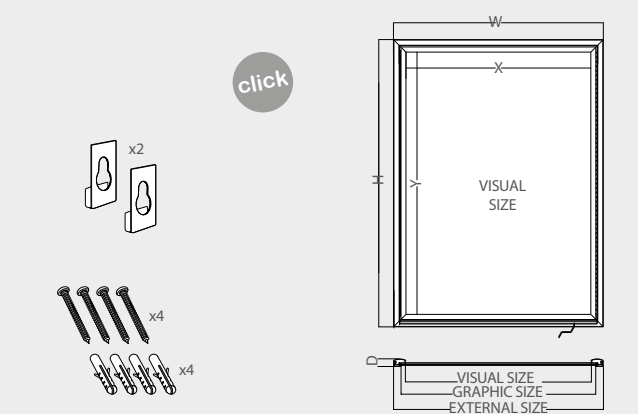

INFORMATION

Artega Light box for daily use combines the power of LED illumination technology with the elegance of a thin anodized aluminium 32mm profile. The frame on each model is 19.75mm thick, making it one of the slimmest marketing devices currently available. The small LED bulbs in the sides prevents against "hot" and "cold" spots appearing on the graphics. Artega Light Box is suitable for wall-mounting. AC power supply and antireflection protector included.

ARTEGA

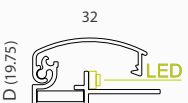

ARTEGA					* W: Width H: Height D: Depth *mm				
Ref.	Graphic Size	Visual (X-Y)	External (WxHxD)	Profile	Packing (QTY)	N.W	G.W	C.B.M	Size (WxHxD)
13.202	A0	815x1163	880x1228x19.75		1	7.25kg	10.1kg	0.0737	910x1350x60
13.203	A1	568x815	633x880x19.75		1	3.95kg	5.5kg	0.0398	660x1005x60
13.204	A2	394x568	459x633x19.75		1	2.1kg	3.1kg	0.0222	490x755x60
13.205	A3	271x394	336x459x19.75		1	1.3kg	1.95kg	0.0128	365x585x60
13.206	A4	184x271	249x336x19.75		1	0.8kg	1.2kg	0.0077	280x460x60
13.293	500x700	474x673	539x738x19.75		1	2.85kg	4.1kg	0.0296	570x865x60
13.294	700x1000	674x974	739x1039x19.75		1	5.3kg	7.3kg	0.0538	770x1165x60

* Other sizes available upon request / Autres dimension sur demande / Outros tamanhos disponíveis sob consulta / Otros tamaños disponibles bajo pedido.

FRAME DETAILS



DIMENSIONS

* W: Width H: Height D: Depth

click

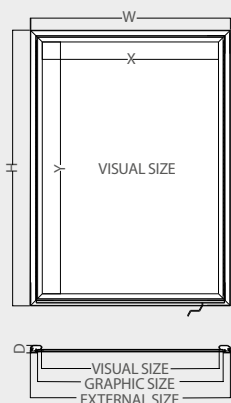
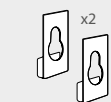

INFORMATION

Campeche Light box frame display is built from sturdy aluminum Click system frame. The small edge-light LED bulbs prevents against "hot" and "cold" spots appearing on the graphics. Campeche Light Box comes with antireflection protector, AC power supply and is suitable for wall-mounting. Designed for day or night time use, the illuminated lightbox stand has clear PVC lens to prevent glare, while the LED bulbs highlight signage.

CAMPECHE

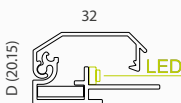

CAMPECHE				* W: Width H: Height D: Depth						*mm
Ref.	Graphic Size	Visual (X-Y)	External (WxHxD)	Profile	Packing (QTY)	N.W	G.W	C.B.M	Size (WxHxD)	
13.217	A0	815x163	880x1228x20.15		1	7.25kg	10.1kg	0.0737	910x1350x60	
13.218	A1	568x815	633x880x20.15		1	3.95kg	5.5kg	0.0398	660x1005x60	
13.219	A2	394x568	459x633x20.15		1	2.1kg	3.1kg	0.0222	490x755x60	
13.220	A3	271x394	336x459x20.15		1	1.3kg	1.95kg	0.0128	365x585x60	
13.221	A4	184x271	249x336x20.15		1	0.8kg	1.2kg	0.0077	280x460x60	
13.291	500x700	474x673	539x738x20.15		1	2.85kg	4.1kg	0.0296	570x865x60	
13.292	700x1000	674x974	739x1039x20.15		1	5.3kg	7.3kg	0.0538	770x1165x60	

* Other sizes available upon request / Autres dimension sur demande / Outros tamanhos disponíveis sob consulta / Otros tamaños disponibles bajo pedido.

FRAME DETAILS



DIMENSIONS

* W: Width H: Height D: Depth

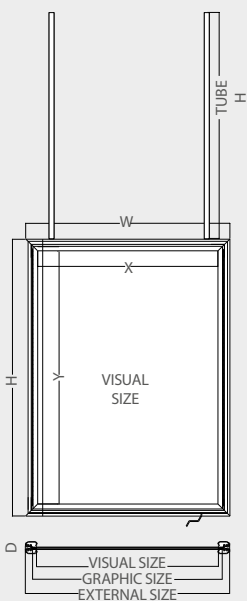

INFORMATION

Nogales 2-sided frame is built from sturdy, durable aluminum frame. With an easy-to-use snap frame, edge-light LED bulbs and antireflection protector. Useful for darker venues, such as halls and movie theaters. The vertical holder tubes, ensuring that the double sided poster display can be seen from any angle. Designed for day or night time use, the illuminated lightbox stand has clear PVC lens to prevent glare, while the LED bulbs highlight signage.

NOGALES



NOGALES

* W: Width H: Height D: Depth

*mm

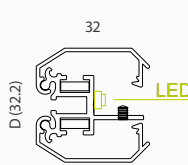
Ref.	Graphic Size	Visual (X-Y)	External (WxHxD)	Tube H	Profile	Packing (QTY)	N.W	G.W	C.B.M	Size (WxHxD)
13.190	A0	815x163	880x1228x32.2	1228		1	10.8kg	13.4kg	0.1050	964x1379x79
13.191	A1	568x815	633x880x32.2	880		1	6.05kg	7.85kg	0.0584	717x1031x79
13.192	A2	394x568	459x633x32.2	633		1	3.5kg	4.6kg	0.0336	543x784x79
13.193	A3	271x394	336x459x32.2	459		1	2.15kg	2.85kg	0.0140	420x610x79
13.194	A4	184x271	249x336x32.2	336		1	1.35kg	1.9kg	0.0128	333x487x79
13.289	500x700	474x673	539x738x32.2	738		1	4.55kg	5.85kg	0.0438	623x890x79
13.290	700x1000	674x974	739x1039x32.2	1039		1	7.95kg	9.95kg	0.0727	790x1165x79

* Other sizes available upon request / Autres dimension sur demande / Outros tamanhos disponíveis sob consulta / Otros tamaños disponibles bajo pedido.

STAND DETAILS



INFORMATION

This multifunction tablet stand provides a Tablet Holder with foam pads for a better grip and a 500x700mm aluminium click frame. Available in grey color. This holder has an 1700mm aluminium pole with heavy silver steel base. Metal enclosure anti-theft system by key lock. Easily rotate 360° the enclosure for displaying portrait or landscape presentation. The tablet cable pass through the pole for a clean look. Request us for 2-sided frame or other Click frame sizes.

DIMENSIONS



TABLET STAND * W: Width H: Height D: Depth

	QTY	N.W	G.W	C.B.M	Size (WxHxD)
Packing	1	8.2kg	8.5kg	0.0097	440x440x50mm
	1	2.8kg	3.6kg	0.0123	80x80x1920mm
	1	1.85kg	2.1kg	0.0026	360x240x30mm
	1	0.2kg	0.32kg	0.0012	195x110x58mm
	1	1.3kg	1.7kg	0.0103	760x545x25mm
	External (WxHxD)		Frame (XxY)		
Product	542x1921x481mm		500x700mm		
13.876		For tablet screen: 9.7" or 10.5"			

CLICK FRAME TABLET STAND



STAND DETAILS

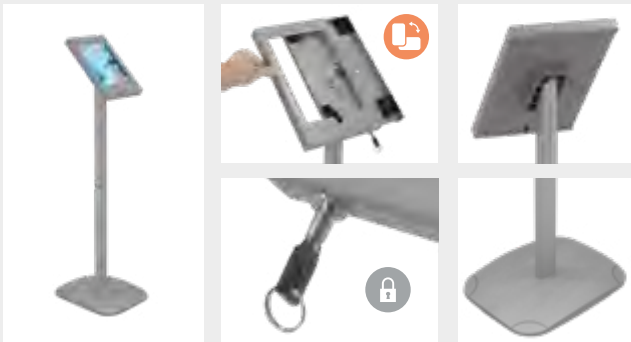

INFORMATION

This Tablet Stand is available in grey color has a metal enclosure anti-theft system and the enclosure rotates easily for portrait or landscape view. Tablet Holder has foam pads for a better grip and to prevent scratches. The tablet cable passes through the pole for a clean look. Cable not included.

DIMENSIONS



TABLET STAND * W: Width H: Height D: Depth

	QTY	N.W	G.W	C.B.M	Size (WxHxD)
Packing	1	1.65kg	1.76kg	0.0036	388x263x35mm
	1	0.75kg	0.95kg	0.0047	930x85x60mm
	1	1.85kg	2.1kg	0.0026	360x240x30mm
	External (WxHxD)				
Product	303x988x328mm				
13.877		For tablet screen: 9.7" or 10.5"			

SLIDING LOCK TABLET STAND

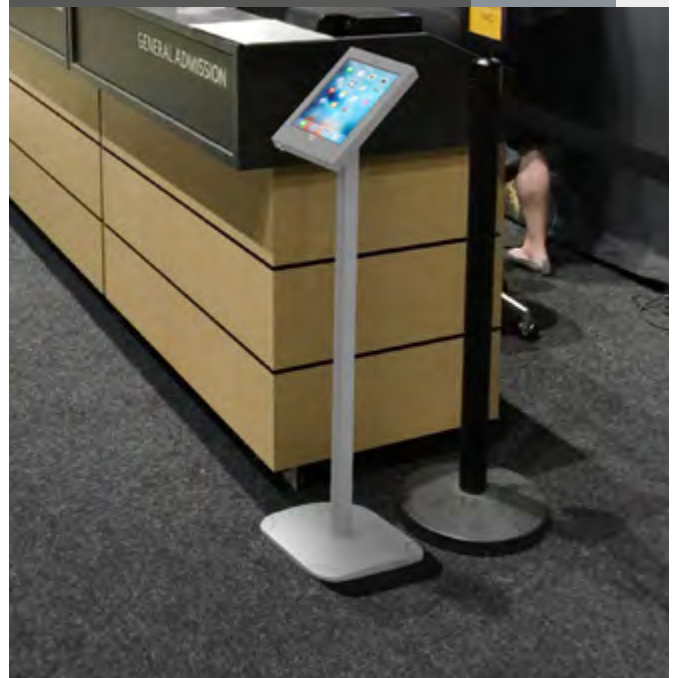

* the tablets at this page are not included.

STAND DETAILS



ACCESSORIES INCLUDED

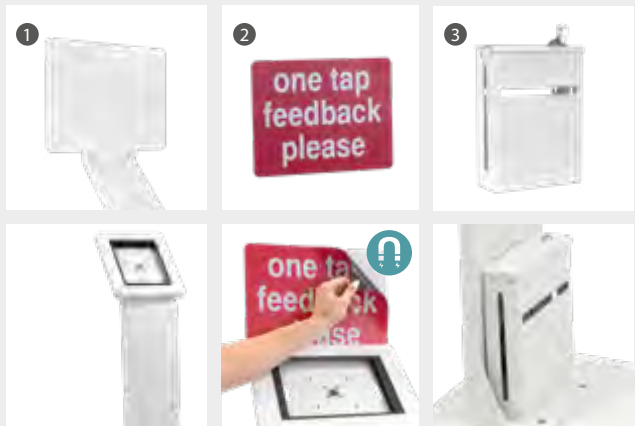

INFORMATION

DIMENSIONS

ARTWORK *mm

This modern slim Tablet Stand is constructed on heavy duty metal. White and black color available. It features a metal enclosure anti-theft system. Tablet Holder has foam pads for a better grip and to prevent scratches. The enclosure rotates easily for portrait or landscape presentation. The tablet cable passes through the stand for a clean look. It is possible to fix a magnetic graphic on the stand front. This tablet stand includes the next accessories: **1** Top banner plate, **2** Top magnetic graphic and **3** Power bank box.

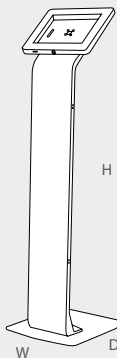

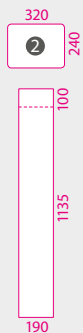

TOTAL GRAPHIC



TABLET STAND

* W: Width H: Height D: Depth

	QTY	N.W	G.W	C.B.M	Size (WxHxD)
Packing	1	15kg	16kg	0.0859	310x1260x220mm
		External (WxHxD)			
Product		340x1280x390mm			
13.858-1		For 9.7" tablet screen			
13.858-2		For 9.7" tablet screen			

FLOOR METAL TABLET STAND



* the tablets at this page are not included.

STAND DETAILS



INFORMATION



This modern designed Console Station is constructed on heavy duty quality steel. Features a enclosure anti-theft system by 2 key locks. The tablet cable passes through the stand for a clean look. Tablet Holder has foam pads for a better grip and to prevent scratches. Black and white finish available. Request us for optional interchangeable magnetic graphic banner.

DIMENSIONS



TABLET STAND

* W: Width H: Height D: Depth

	QTY	N.W	G.W	C.B.M	Size (WxHxD)
Packing	1	23kg	26.50kg	0.219	1340x430x380mm
	External (WxHxD)				
Product	360x1260x300mm				
13.857-1		For tablet screen: 9.7" or 10.5"			
13.857-2		For tablet screen: 9.7" or 10.5"			

CONSOLE STATION TABLET STAND



STAND DETAILS

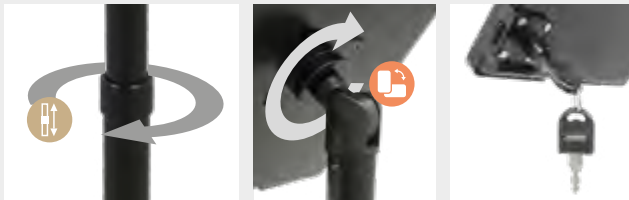

INFORMATION

This black finished Tablet stand is designed for both sitting and standing thanks its telescopic pole. Also, an anti-theft system keeps the technology safely locked. Users may easily rotate 360° or tilt the bracket of the adjustable tablet floor stand for different viewing angles. Tablet Holder has foam pads for a better grip and to prevent scratches. The holder's touchscreen unique design allows access to the home and power buttons while also leaving the auxiliary port open, perfect for credit card readers.

DIMENSIONS

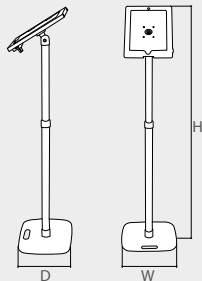

TABLET STAND

* W: Width H: Height D: Depth

	QTY	N.W	G.W	C.B.M	Size (WxHxD)
Packing	1	6kg	7kg	0.035	390x110x760mm
	External (WxHxD)				
Product	245x1350x280mm				
10.306		For Tablet: ± 242.8x189.7mm			

ADJUSTABLE POLE TABLET STAND

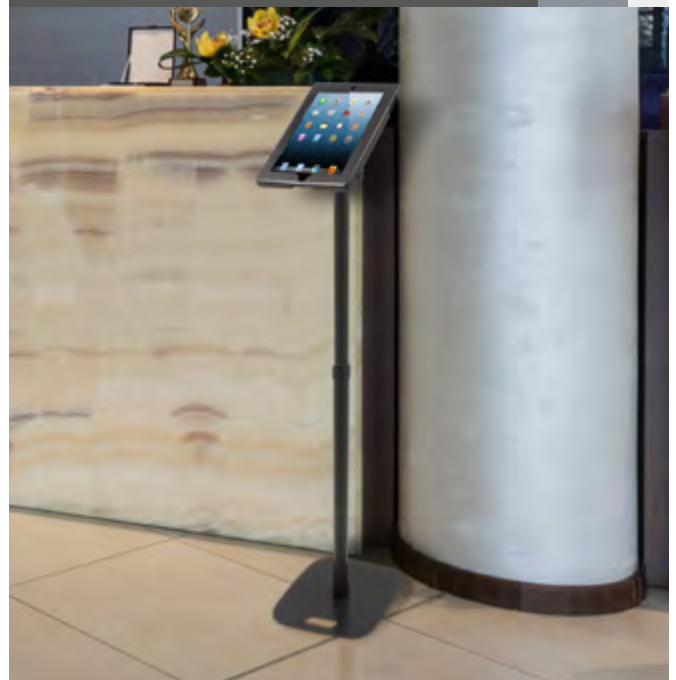

* the tablets at this page are not included.

STAND DETAILS

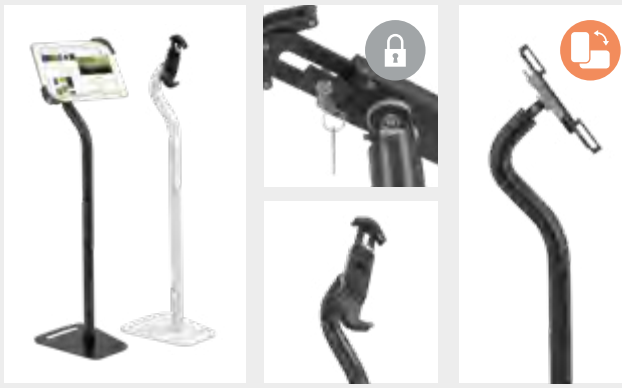

INFORMATION

This swan neck Tablet Stand is available in white or black finish. This holder has an universal enclosure anti-theft system. With Kensington hole for additional security. Easily rotates 360° and tilts the enclosure for displaying in different view angles. The tablet cable passes through the pole for getting a clean look.



DIMENSIONS

TABLET STAND * W: Width H: Height D: Depth

	QTY	N.W	G.W	C.B.M	Size (WxHxD)
Packing	1	6.25kg	7kg	0.041	890x420x110
		External (WxHxD)			
Product		300x1190x380mm			
13.856-1		For Tablets from 7.9" to 10.5"			
13.856-2		For Tablets from 7.9" to 10.5"			

SWAN CLAMP
TABLET STAND

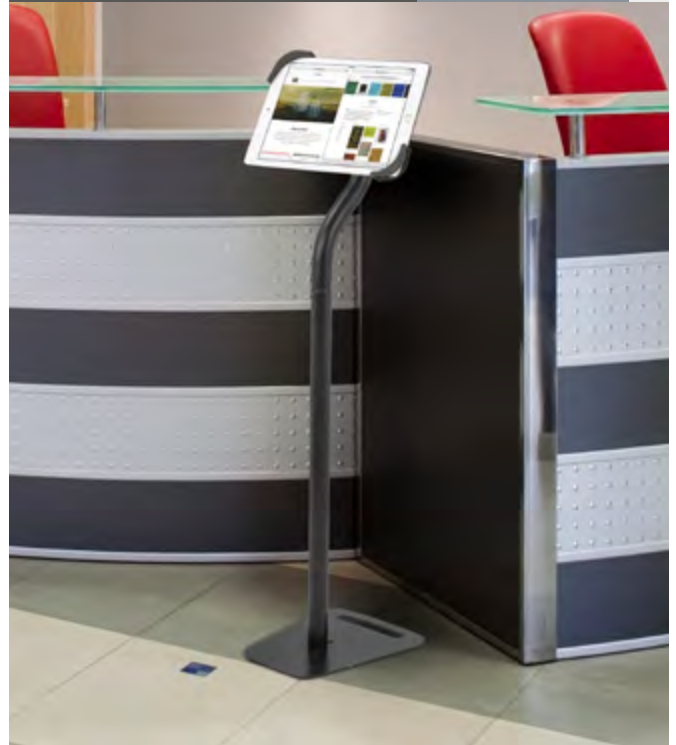

STAND DETAILS





INFORMATION

This 2-in-1 tablet support is designed for floor or desk use. White or black color. Tablet Holder has foam pads for a better grip and to prevent scratches. With metal enclosure anti-theft system and Kensington hole. Holder easily rotates for portrait or landscape display. The tablet cable passes through the pole for a clean look.



DIMENSIONS

TABLET STAND | DESK * W: Width H: Height D: Depth

	QTY	N.W	G.W	C.B.M	Size (WxHxD)
Packing	1	7kg	8kg	0.041	890x420x110
		External (WxHxD)			
Product		300x1190x380mm			
13.855-1		For 9.7" or 10.5" tablets			
13.855-2		For 9.7" or 10.5" tablets			

FLOOR & DESKTOP
TABLET STAND



* the tablets at this page are not included.

STAND DETAILS

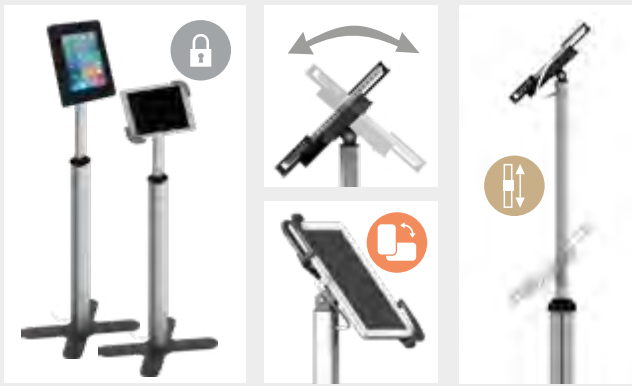

INFORMATION

This tablet floor stand is designed for both sitting and standing use thanks to its telescopic pole. In addition, this stand has two available holding systems, universal clamp or metal enclosure. Holder easily rotates 360° and tilts for displaying in different view angles. The tablet cable passes through the pole for a clean look.



DIMENSIONS

TABLET STAND * W: Width H: Height D: Depth *mm

	QTY	N.W	G.W	C.B.M	Size (WxHxD)
Packing	1	6.25kg	7kg	0.041	890x420x110
		Height (H)			
Product		800-1300			
13.868	Universal clamp for tablets from ± 7.9" to 10.5"				
13.869	Metal enclosure for tablet screen ± 9.7" or 10.5"				

DOUBLE ENCLOSURE TELESCOPIC TABLET STAND



STAND DETAILS



INFORMATION

This Tablet Holder is designed for desk or wall mounting. Also, an anti-theft system keeps the technology safely locked. It has foam pads for a better grip and to prevent the scratches. The touchscreen holder's unique design allows access to the home and power buttons while also leaving the auxiliary port open, perfect for credit card readers. The bracket rotates easily 90° for different viewing angles.

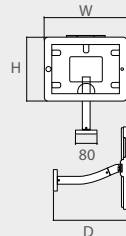

DIMENSIONS * mm

TABLET WALL | DESK * W: Width H: Height D: Depth

	QTY	N.W	G.W	C.B.M	Size (WxHxD)
Packing	1	1kg	1.55kg	0.006	365x92x204mm
		External (WxHxD)			
Product		248x194x270mm			
14.108	For Tablet: ± 240x185mm				

METAL FRAME WALL DESK TABLET HOLDER



* the tablets at this page are not included.

HOLDER DETAILS



INFORMATION

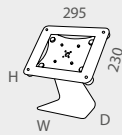

Desktop support with Z shape aluminium base and Kensington hole for additional security. Acrylic enclosure locks by 4 screws and rotates for portrait or landscape display. Tablet Holder has foam pads for a better grip and to prevent scratches. Compatible install of Square-Paypal card readers. Black and white colour.

DIMENSIONS * mm



TABLET DESK

* W: Width H: Height D: Depth

	QTY	N.W	G.W	C.B.M	Size (WxHxD)
Packing	1	1.75kg	1.92kg	0.0201	340x200x295mm
		External (WxHxD)			
Product		210x300x150mm			
13.851-1					For 9.7" or 10.5" tablets
13.851-2					For 9.7" or 10.5" tablets

ACRYLIC FRAME DESK TABLET HOLDER

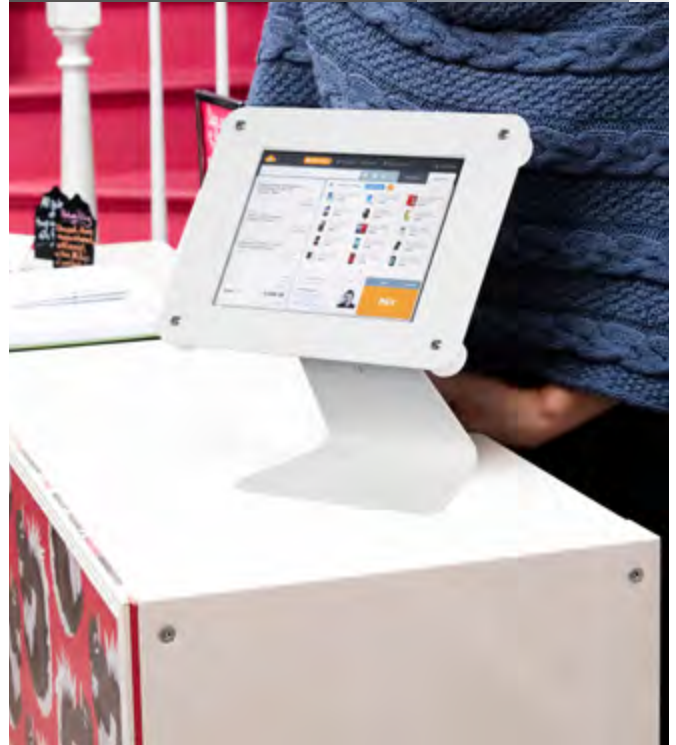

HOLDER DETAILS



INFORMATION

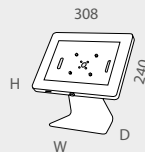

Desktop Tablet support with Z shape aluminium base and kensington hole for additional security. Metal enclosure locking with key and rotates for portrait or landscape display. Tablet Holder has foam pads for a better grip and to prevent scratches. Available in black and white.

DIMENSIONS * mm



TABLET DESK

* W: Width H: Height D: Depth

	QTY	N.W	G.W	C.B.M	Size (WxHxD)
Packing	1	1.75kg	1.92kg	0.0201	340x200x295mm
		External (WxHxD)			
Product		210x315x150mm			
13.852-1					For 9.7" or 10.5" tablets
13.852-2					For 9.7" or 10.5" tablets

METAL CASE "Z" BASE DESK HOLDER



* the tablets at this page are not included.

HOLDER DETAILS



INFORMATION

DIMENSIONS * mm

Desktop tablet holder with open "Z" shape metal base and an adjustable universal holder with anti-theft enclosure system. This enclosure easily rotates 360° and tilts for displaying in different view angles. Base with mounting holes for permanent installation. Black and white colour available.

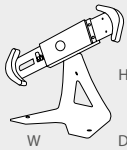

TABLET DESK

* W: Width H: Height D: Depth

	QTY	N.W	G.W	C.B.M	Size (WxHxD)
Packing	1	1.24kg	1.57kg	0.02	330x170x290mm
		External (WxHxD)	Base		
Product		325x295x150mm	200x150mm		
13.865-1		For tablets from 7.9" to 10.5"			
13.865-2		For tablets from 7.9" to 10.5"			

UNIVERSAL FRAME
OPEN "Z" BASE DESK HOLDER

NEW

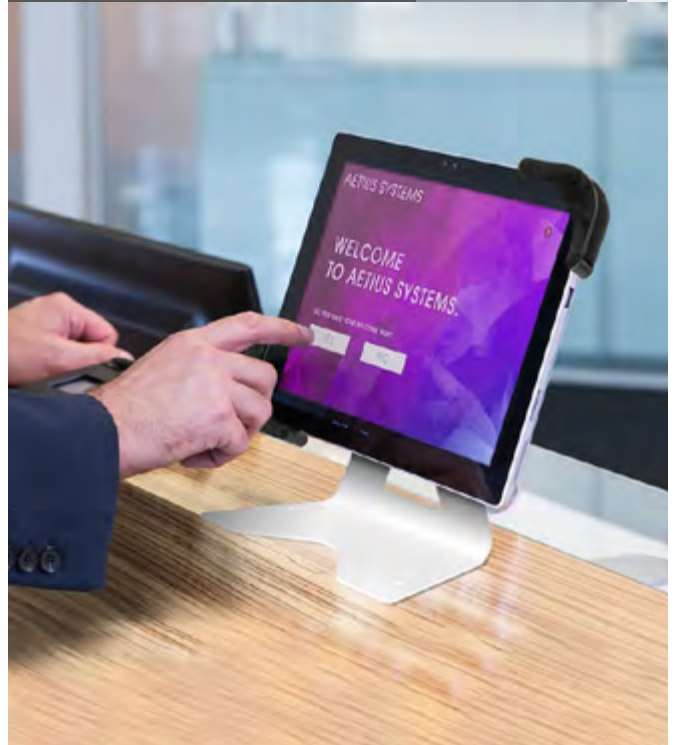

HOLDER DETAILS



INFORMATION

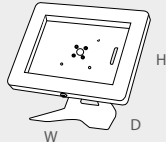

DIMENSIONS * mm

Desktop tablet holder with open "Z" shape metal base with mounting holes. Metal enclosure with key lock and Kensington hole for additional security. The Case easily rotates 360° and tilts for displaying in different view angles. Foam Pads included for a better fitting. Black and white colour available.



TABLET DESK

* W: Width H: Height D: Depth

	QTY	N.W	G.W	C.B.M	Size (WxHxD)
Packing	1	2.08kg	2.41kg	0.02	330x170x280mm
		External (WxHxD)	Base		
Product		310x270x180mm	200x150mm		
13.859-1		For 9.7" or 10.5" tablets			
13.859-2		For 9.7" or 10.5" tablets			

METAL CASE
OPEN "Z" BASE DESK HOLDER

NEW



* the tablets at this page are not included.

HOLDER DETAILS



INFORMATION

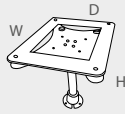

DIMENSIONS * mm

Desktop or wall mounting tablet support with full range of movement thanks to its durable metal flexing column. Acrylic enclosure locks by 4 screws and rotates for portrait or landscape display. Compatible install of Square-Paypal card readers. Available in black and white.



TABLET WALL | DESK

* W: Width H: Height D: Depth

	QTY	N.W	G.W	C.B.M	Size (WxHxD)
Packing	1	1.33kg	1.83kg	0.0113	350x280x115mm
	External (WxHxD)				
Product	295x250x230mm				
13.853-1		For 9.7" or 10.5" tablets			
13.853-2		For 9.7" or 10.5" tablets			

FLEX ACRYLIC WALL DESK TABLET HOLDER



HOLDER DETAILS

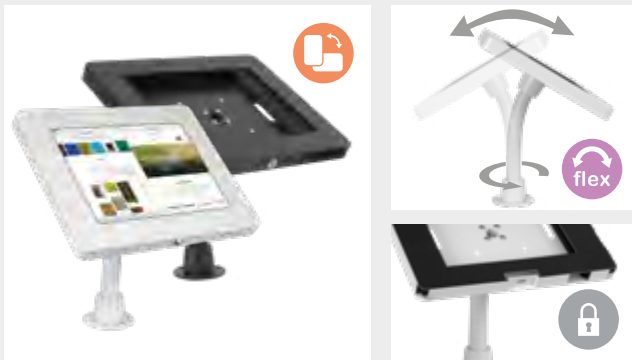

INFORMATION

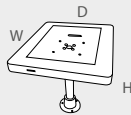

DIMENSIONS * mm

Desktop or wall mounting tablet support with full range of movement thanks to its durable metal flexing column. Metal enclosure locks with key and kensington hole for additional security. Tablet Holder has foam pads for a better grip and to prevent scratches. Available in black and white.



TABLET WALL | DESK

* W: Width H: Height D: Depth

	QTY	N.W	G.W	C.B.M	Size (WxHxD)
Packing	1	1.33kg	1.83kg	0.0113	350x280x115mm
	External (WxHxD)				
Product	310x250x240mm				
13.854-1		For 9.7" or 10.5" tablets			
13.854-2		For 9.7" or 10.5" tablets			

FLEX METAL CASE WALL DESK TABLET HOLDER



* the tablets at this page are not included.

HOLDER DETAILS

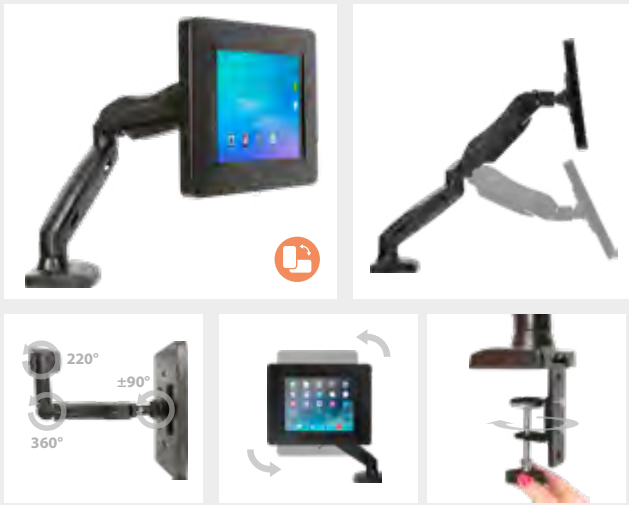

INFORMATION

DIMENSIONS * mm

Desktop Tablet support with all direction effortless adjustment and Kensington security hole. Metal enclosure locking with key and 360° rotates for portrait or landscape display. With integrated cable holder, two bottom fixing ways and foam pads for holding the tablet.

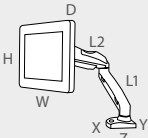

TABLET DESK

* W: Width H: Height D: Depth

	QTY	N.W	G.W	C.B.M	Size (WxHxD)
Packing	1	4.17kg	4.6kg	0.02	385x140x310mm
		Case (WxHxD)	Base (XxYxZ)	Arm (L1+L2)	
Product		310x240x25mm	91x105x45mm	250x340mm	
13.866-2			For 9.7" or 10.5" tablets		

**BALANCE ARM
DESK TABLET HOLDER**



HOLDER DETAILS

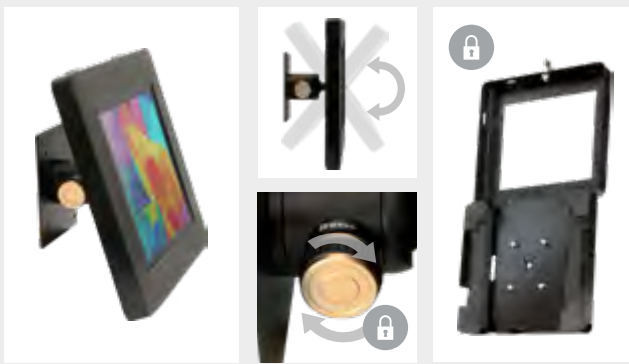

INFORMATION

DIMENSIONS * mm

Wall or desktop mounting tablet holder with wide range of movement thanks to its Ball Head with control Knob. Metal enclosure locks with key and Kensington hole for additional security. Tablet Holder has foam pads for a better grip and to prevent scratches. Bracket with mounting holes.

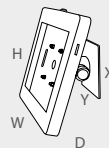

TABLET WALL | DESK

* W: Width H: Height D: Depth

	QTY	N.W	G.W	C.B.M	Size (WxHxD)
Packing	1	1.67kg	1.92kg	0.01	330x120x280mm
		External (WxHxD)	Base(XxY)		
Product		310x240x107mm	120x120mm		
13.867-2			For 9.7" or 10.5" tablets		

**BALL HEAD CASE
WALL TABLET HOLDER**



* the tablets at this page are not included.

STAND DETAILS



INFORMATION

The Sligo Lectern features a double A4-Size reading metallic surface with ring binder. Sligo is ideal for displaying menus at the restaurant entrances, catalogues at retail stores or for presentations at the auditoriums.

DIMENSIONS

*mm

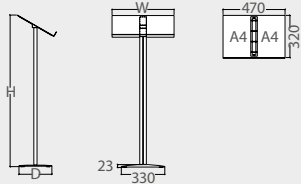

SLIGO METALLIC

* W: Width H: Height D: Depth

	QTY	N.W	G.W	C.B.M	Size (WxHxD)	
Packing	1	4.3kg	4.7kg	0.0107	330x500x65mm	 x2
	1	1.15kg	1.3kg	0.0028	40x1070x65mm	
	External (WxHxD)					
Product	470x1147x250mm					
10.984	Literature Holder: A4 (x2)					

SLIGO METALLIC BINDER

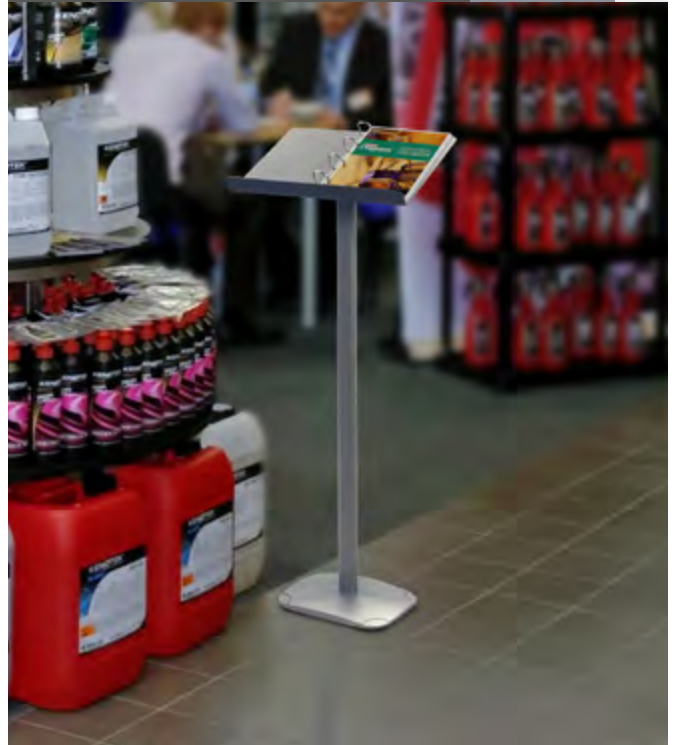

STAND DETAILS



INFORMATION

The Sligo Lectern features a double A4-Size reading acrylic surface with ring binder. Sligo is ideal for displaying menus at the restaurant entrances, catalogues at retail stores or for presentations at the auditoriums.

DIMENSIONS

*mm

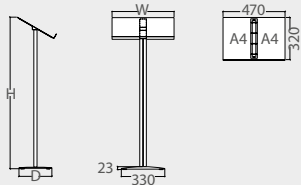

SLIGO ACRYLIC

* W: Width H: Height D: Depth

	QTY	N.W	G.W	C.B.M	Size (WxHxD)	
Packing	1	2.75kg	3kg	0.0107	330x500x65mm	 x2
	1	1.15kg	1.3kg	0.0028	40x1070x65mm	
	External (WxHxD)					
Product	470x1147x250mm					
10.983	Literature Holder: A4 (x2)					

SLIGO ACRYLIC BINDER



STAND DETAILS



DIMENSIONS

REF 13.123

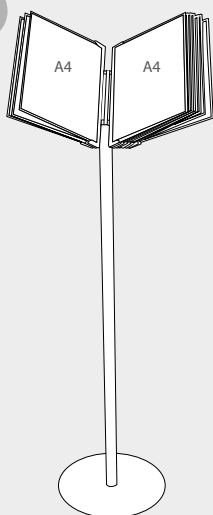

REF 13.122

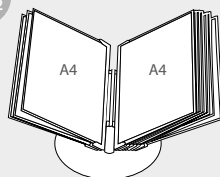

INFORMATION

This Binder Stands are made of steel, rubber and plastic and includes 10 A4 format plastic sleeves. There are 2 models available: desktop option or with solid and stand base. Ideal for restaurants, coffee stores as menu holder or for trade shows and retail stores for being used as a catalogue display-book.

MENUBOOK 1	QTY	N.W	G.W	C.B.M	SIZE
Packing	1	1.9kg	2.15kg	0.012	340x100x360 mm
13.122	Graphic Size: A4 "Black"			x1	
MENUBOOK 2	QTY	N.W	G.W	C.B.M	SIZE
Packing	1	5.2kg	5.4kg	0.018	345x155x345 mm
13.123	Graphic Size: A4 "Black"			x1	

PLASTIC POCKETS BINDER STAND

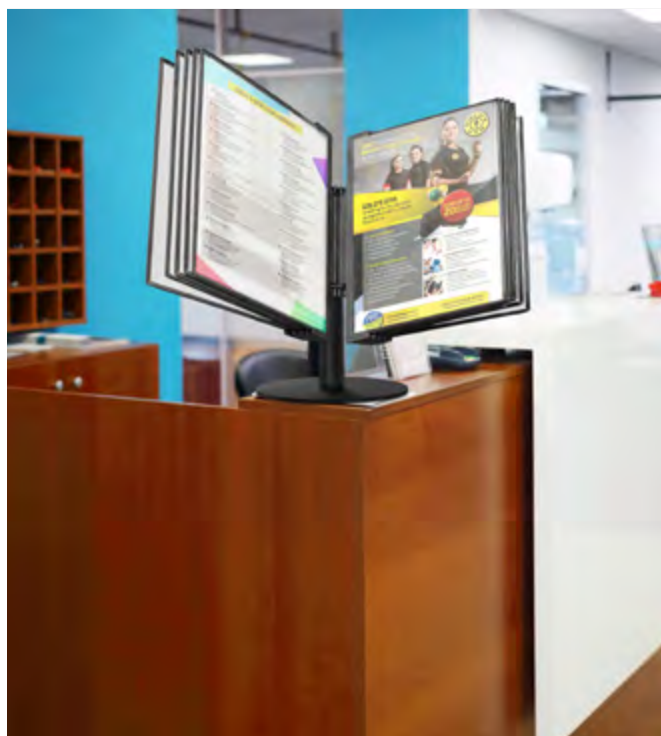
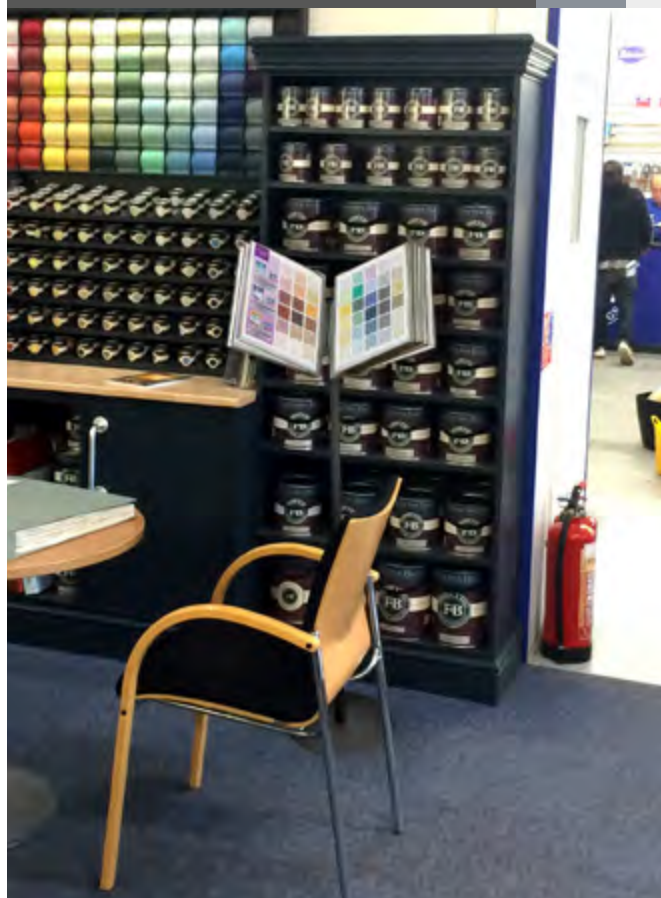

HOLDER DETAILS



INFORMATION

DIMENSIONS * mm

This Display for catalogs is made of 3mm thickness acrylic and features a 4 rings binder. This transparent Stand can display 2 portrait A4 format documents, so it is an excellent addition to any retail store or personal collection for the exhibition of promotional catalogues.

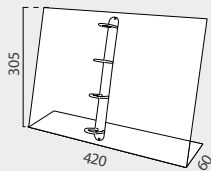

CATALOGUE	SIZE	THICKNESS	
13.043	A4 + A4	3mm	x2 

ACRYLIC CATALOGUE HOLDER



STAND DETAILS



INFORMATION

DIMENSIONS * mm

This Display for catalogs is made of 3mm thickness acrylic and features a 4 rings binder. This transparent Stand can display landscape A4 format documents and it is double-sided, so it is an excellent addition to any retail store or personal collection for the exhibition of promotions.

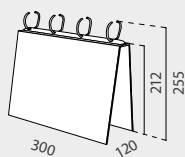

RING BINDER	SIZE	THICKNESS	
13.404	A4 + A4	3mm	x2 

ACRYLIC RING BINDER



STAND DETAILS



INFORMATION

DIMENSIONS

* mm

This stylish stand is made of aluminum and acrylic with a metal base that provides greater stability. Features an A5 sandwich graphic holder for an easy graphic change. Also it has an useful 1/3 A4 leaflet dispenser.

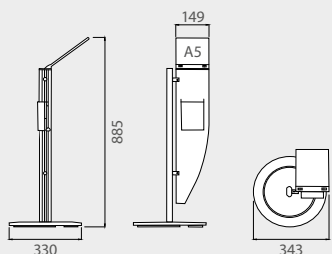

NEILA	SIZE	GRAPHIC SIZE	LEAFLET
13.675	343x885x330mm	A5	1/3 A4 x1 

NEILA



STAND DETAILS





INFORMATION

DIMENSIONS

* mm

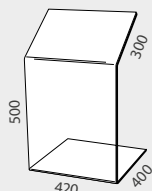
This stand is made of 8mm thickness acrylic and features a graphic holder (300x420mm) for displaying relevant information of products. This acrylic stand is great for displaying offers inserting the stand between the mattresses and the base. Ability to fix an A3 Adhesive PVC Pocket ref. 13.064 (sold separately) to exchange the graphics quicker.



ACRYLIC STAND	SIZE	GRAPHIC SIZE	THICKNESS
50.339	400x420x715mm	300x420mm	8mm x2 

ACRYLIC INFO FLOOR STAND



ALUMINIUM
LECTERN





STAND DETAILS

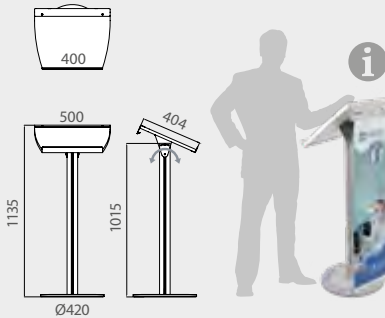

DIMENSIONS AND OPTIONAL ACCESSORY 

*mm



 The back of the surface of this Lectern provides the possibility of attaching an Alulon Poster System (Ref: 10571) to place a banner and customize the look of the lectern. For more information, see Signage chapter.

INFORMATION

This aluminium lectern includes a 19mm thickness white wooden reading surface with a matching aluminum post and circular base offering modern visual displays. The reading surface on this lectern includes a book stop to support your notes during a presentation for award recipients, sheet music for a performance, or a seating chart to assist a hostess, also it features an adjustable angle view for the reading surface. With its sleek contemporary design, this podium is easy to assemble, requiring only a screwdriver and a few minutes. Its silver aluminum pole and base are durable and will last through years of performances and presentations. This stylish yet affordable lectern is a great addition to any presentation space, such as auditoriums, restaurants for menu displays or convention centers to attract the attention of your audience.



Ref: 10571

Alulon Poster System
see in Signage chapter
(Optional accessory)

ALUMINIUM LECTERN * W: Width H: Height D: Depth

	QTY	N.W	G.W	C.B.M	Size (WxHxD)	
Packing	1	8.2kg	8.5kg	0.0097	440x440x50mm	 x3
	1	1.59kg	1.75kg	0.0067	80x80x1040mm	
	1	3.95kg	4.7kg	0.0413	530x445x175mm	
	External (WxHxD)					
Product	± 500x1135x420mm					
13.640						

STAND DETAILS



MULTIFUNCTIONAL
PATENTED SYSTEM
SHELF STAND

no tools
required
no screws

DIMENSIONS AND OPTIONAL ACCESSORY  *mm

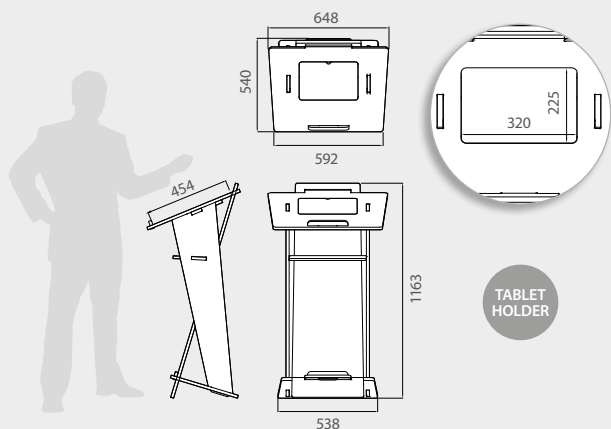

INFORMATION

This stunning wooden lectern does not require the use of any tools for its assembly thanks to its Patent System. Each of its 10 pieces is designed to complete a sturdy and firm structure in very few steps. It is made of 16mm thickness Waterproof MDF Wood with a natural stylish grey finish. It features one shelf in the interior of the lectern, so this way, the extra brochures, business cards and documents can be stored out of sight so your exhibition always appears clean and organized. Also, it features a 320x225mm holder at the top surface for placing securely a tablet. The Removable Wooden Lectern is ideal for being used at auditoriums or convention centers to attract the attention of your audience.

WOODEN LECTERN

	QTY	N.W	G.W	C.B.M	Size (WxHxD)
Packing	1	19kg	21.41kg	0.0832	605x105x1310mm
13.641					

REMOVABLE
WOODEN LECTERN



LECTERN SET-UP 10 MANUALLY ATTACHABLE PARTS



* the tablets at this page are not included.

STAND DETAILS



DIMENSIONS

* W: Width H: Height D: Depth * mm

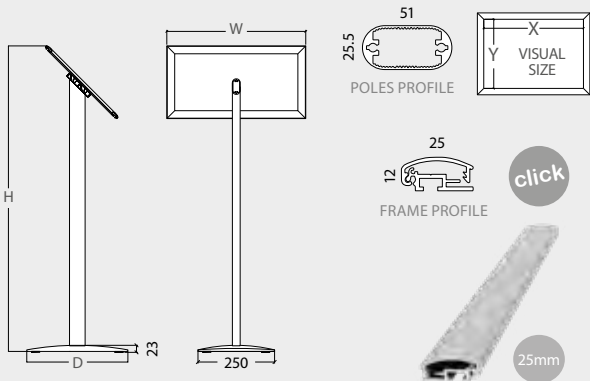

INFORMATION

Zafra Menu Stand features a sturdy aluminium structure with plastic parts. Its Click System frame allows an easy and quick graphic change (antireflection protector included). Frames features portrait or a landscape configuration. It is ideal for retail stores, hotel lobbies, restaurants, and real states.

ZAFRA A3		W: Width	H: Height	D: Depth			
	QTY	N.W	G.W	C.B.M	Size (WxHxD)		
Packing	1	0.75kg	0.95kg	0.0047	60x930x85mm	 x3	
	1	1.65kg	1.76kg	0.0034	275x355x35mm		
	1	0.65kg	0.85kg	0.0061	365x480x35mm		
		Visual (X-Y)	External (WxHxD)				
Product		400x277mm	453x998x330mm				
10.159	Graphic Size: A3						

ZAFRA A4		W: Width	H: Height	D: Depth			
	QTY	N.W	G.W	C.B.M	Size (WxHxD)		
Packing	1	0.75kg	0.95kg	0.0047	60x930x85mm	 x3	
	1	1.65kg	1.76kg	0.0034	275x355x35mm		
	1	0.45kg	0.55kg	0.0024	270x350x25mm		
		Visual (X-Y)	External (WxHxD)				
Product		190x278mm	311x960x330mm				
10.158	Graphic Size: A4						

ZAFRA



STAND DETAILS



DIMENSIONS

* W: Width H: Height D: Depth * mm

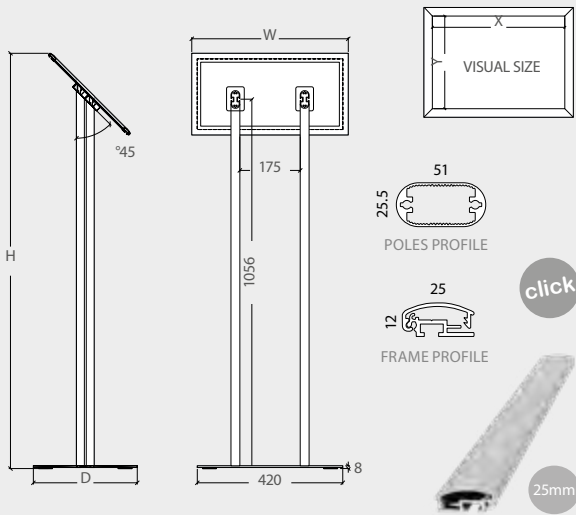

INFORMATION

This Ulster Menu Stand is made of aluminium and features an antireflection protector for its A3 frame. The Ulster frame borders snap open which allows you to insert quickly and easily your printed graphics. Also, it features the option of customize with an inside graphic. It is ideal for hotel lobbies, for restaurant entrances, car dealerships or real states.

ULSTER W: Width H: Height D: Depth

	QTY	N.W	G.W	C.B.M	Size (WxHxD)
Packing	1	2.15kg	2.5kg	0.0102	145x1170x60mm
	1	5kg	5.3kg	0.0061	365x480x35mm
	1	0.65kg	0.85kg	0.0061	365x480x35mm
		Visual (X-Y)	External (WxHxD)		
Product		400x277mm	452x1200x300		
10.982		Graphic Size: A3			

 x3

ULSTER



STAND DETAILS

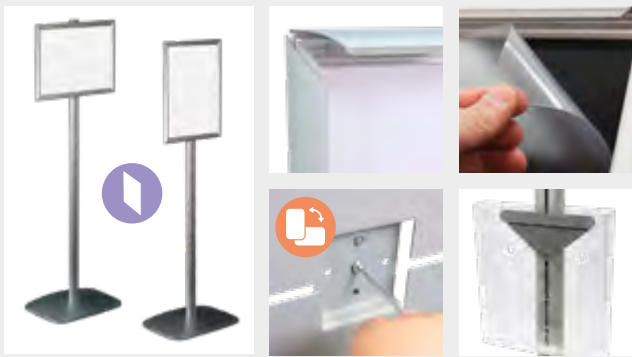

DIMENSIONS

* W: Width H: Height D: Depth * mm

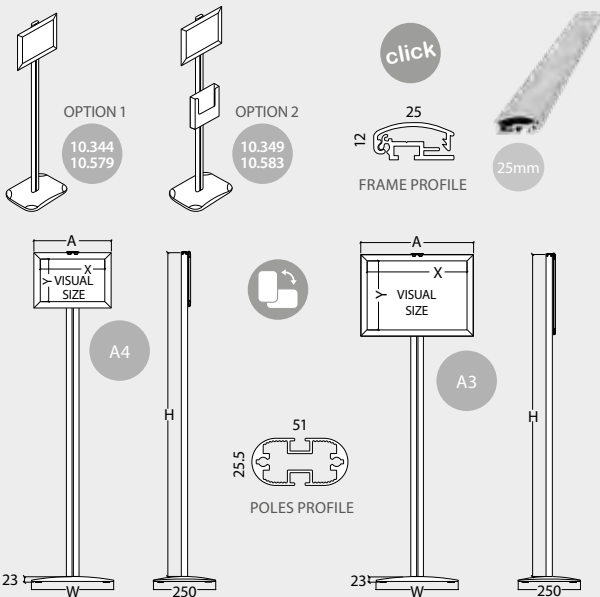

INFORMATION



Melgar 1-sided features a sturdy aluminium structure with plastic parts. Its Click System frame allows an easy and quick graphic change (antireflection protector included). Frames allows an easy portrait or a landscape change configuration. Also Melgar is available with an A4 leaflet dispenser. It is ideal for retail stores, hotel lobbies, restaurant entrances, car dealerships and real states.

MELGAR ONE-SIDED





MELGAR A4 1SIDED

W: Width H: Height D: Depth

	QTY	N.W	G.W	C.B.M	Size (WxHxD)	
Packing	1	1.15kg	1.25kg	0.0035	65x1340x40mm	 x3 
	1	2.8kg	2.93kg	0.0036	263x388x35mm	
	1	0.82kg	0.91kg	0.0024	350x270x25mm	
		Visual (X-Y)	External (WxHxA)			
Product		190x278mm	330x1326x311mm			
10.344	Graphic Size: A4					



MELGAR A3 1SIDED

W: Width H: Height D: Depth

	QTY	N.W	G.W	C.B.M	Size (WxHxD)	
Packing	1	1.15kg	1.25kg	0.0035	65x1340x40mm	 x3 
	1	2.8kg	2.93kg	0.0032	263x388x35mm	
	1	1.44kg	1.74kg	0.0042	475x355x25mm	
		Visual (X-Y)	External (WxHxA)			
Product		278x401mm	330x1326x453mm			
10.579	Graphic Size: A3					



MELGAR A4 1S+DISPENSER

W: Width H: Height D: Depth

	QTY	N.W	G.W	C.B.M	Size (WxHxD)	
Packing	1	1.15kg	1.25kg	0.0035	65x1340x40mm	 x4 
	1	2.8kg	2.93kg	0.0036	263x388x35mm	
	1	0.4kg	0.55kg	0.0029	235x250x50mm	
	1	0.82kg	0.91kg	0.0024	350x270x25mm	
		Visual (X-Y)	External (WxHxA)			
Product		190x278mm	330x1326x311mm			
10.349	Graphic Size: A4		with A4  x1			

MELGAR A3 1S+DISPENSER

W: Width H: Height D: Depth

	QTY	N.W	G.W	C.B.M	Size (WxHxD)	
Packing	1	1.15kg	1.25kg	0.0035	65x1340x40mm	 x4 
	1	2.8kg	2.93kg	0.0036	263x388x35mm	
	1	0.4kg	0.55kg	0.0029	235x250x50mm	
	1	1.44kg	1.74kg	0.0042	475x355x25mm	
		Visual (X-Y)	External (WxHxA)			
Product		278x401mm	330x1326x453mm			
10.583	Graphic Size: A3		with A4  x1			

STAND DETAILS



DIMENSIONS

* W: Width H: Height D: Depth * mm

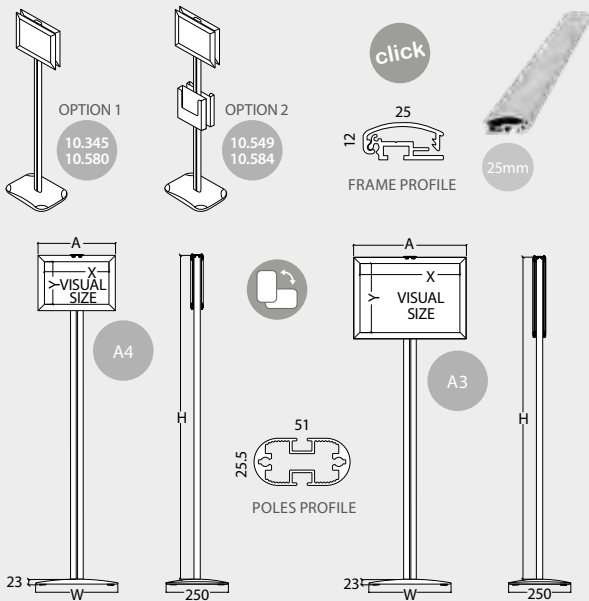

INFORMATION



Melgar 2-sided features a sturdy aluminium structure with plastic parts. Its Click System frame allows an easy and quick graphic change (antireflection protector included). Frames allows an easy portrait or a landscape change configuration. Also Melgar is available with an A4 leaflet dispenser. It is ideal for retail stores, hotel lobbies, restaurant entrances, car dealerships and real states.

MELGAR TWO-SIDED





MELGAR A4 2SIDED

W: Width H: Height D: Depth

	QTY	N.W	G.W	C.B.M	Size (WxHxD)	
Packing	1	1.15kg	1.25kg	0.0035	65x1340x40mm	 x4 
	1	2.8kg	2.93kg	0.0036	263x388x35mm	
	2	0.82kg	0.91kg	0.0024	350x270x25mm	
Product	Visual (X-Y)		External (WxHxA)			
	190x278mm		330x1326x329mm			
10.345	Graphic Size: A4					



MELGAR A3 2SIDED

W: Width H: Height D: Depth

	QTY	N.W	G.W	C.B.M	Size (WxHxD)	
Packing	1	1.15kg	1.25kg	0.0035	65x1340x40mm	 x4 
	1	2.8kg	2.93kg	0.0036	263x388x35mm	
	2	1.44kg	1.74kg	0.0042	475x355x25mm	
Product	Visual (X-Y)		External (WxHxA)			
	278x401mm		330x1326x453mm			
10.580	Graphic Size: A3					



MELGAR A4 2S+2 DISPENSERS

W: Width H: Height D: Depth

	QTY	N.W	G.W	C.B.M	Size (WxHxD)	
Packing	1	1.15kg	1.25kg	0.0035	65x1340x40mm	 x6 
	1	2.8kg	2.93kg	0.0036	263x388x35mm	
	2	0.4kg	0.55kg	0.0029	235x250x50mm	
	2	0.82kg	0.91kg	0.0024	350x270x25mm	
	Visual (X-Y)		External (WxHxA)			
Product	190x278mm		330x1326x311mm			
10.549	Graphic Size: A4		with A4  x2			

MELGAR A3 2S+2 DISPENSERS

W: Width H: Height D: Depth

	QTY	N.W	G.W	C.B.M	Size (WxHxD)	
Packing	1	1.15kg	1.25kg	0.0035	65x1340x40mm	 x6 
	1	2.8kg	2.93kg	0.0036	263x388x35mm	
	2	0.4kg	0.55kg	0.0029	235x250x50mm	
	2	1.44kg	1.74kg	0.0042	475x355x25mm	
	Visual (X-Y)		External (WxHxA)			
Product	278x401mm		330x1326x453mm			
10.584	Graphic Size: A3		with A4  x2			

STAND DETAILS



DIMENSIONS

* W: Width H: Height D: Depth * mm

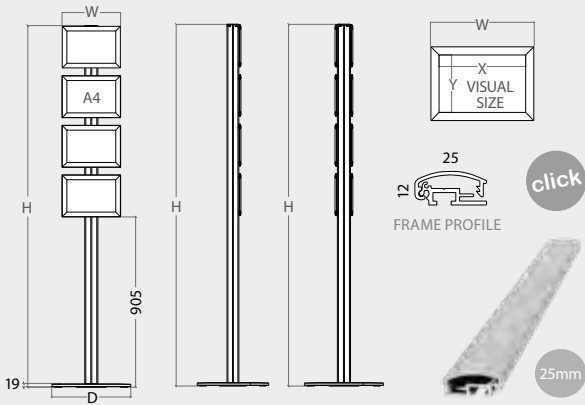

INFORMATION

Info Stands can be used in a variety of locations to showcase eye-catching signage. These stands are made of aluminum with a smooth silver finish and they are equipped with A4 click frames (antireflection protector included). It features a 8kg weight steel base. If you choose single-sided model you can display 4xA4-sized graphics or 8xA4-sized graphics for double-sided model.

GUADALUPE A4 SINGLE

W: Width H: Height D: Depth

	QTY	N.W	G.W	C.B.M	Size (WxHxD)	
Packing	1	2.8kg	3.6kg	0.0123	80x1920x80mm	 x6 
	1	8.2kg	8.5kg	0.0097	440x440x50mm	
	4	0.45kg	0.55kg	0.0024	270x350x25mm	
Product	Visual (X-Y)		External (WxHxD)			
	190x278mm		311x1922x Ø420mm			
10.154	Graphic Size: A4 x 4uni.					

GUADALUPE A4 DOUBLE

W: Width H: Height D: Depth

	QTY	N.W	G.W	C.B.M	Size (WxHxD)	
Packing	1	2.8kg	3.6kg	0.0123	80x1920x80mm	 x10 
	1	8.2kg	8.5kg	0.0097	440x440x50mm	
	8	0.45kg	0.55kg	0.0024	270x350x25mm	
Product	Visual (X-Y)		External (WxHxD)			
	190x278mm		311x1922x Ø420mm			
10.156	Graphic Size: A4 x 8uni.					

GUADALUPE A4

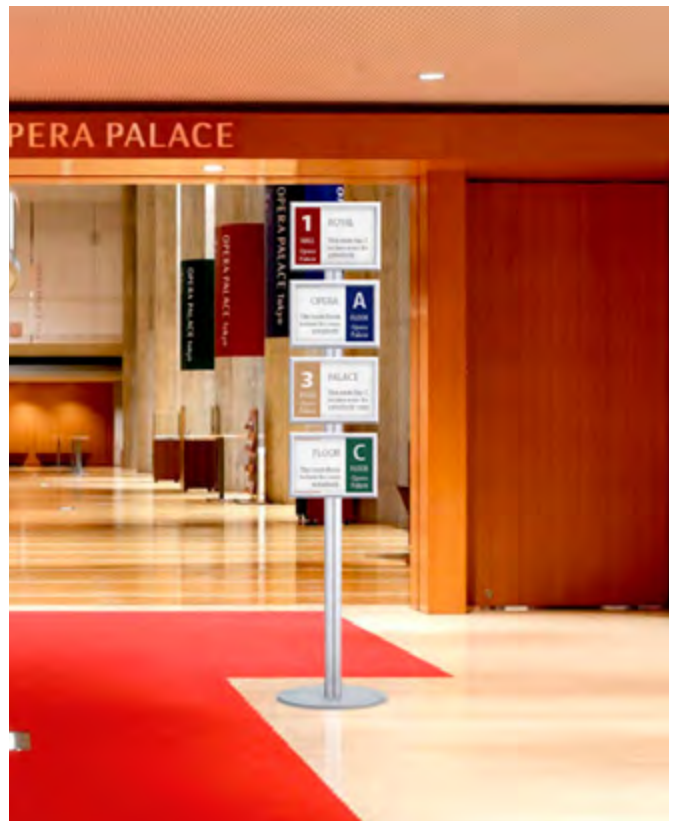

STAND DETAILS



DIMENSIONS

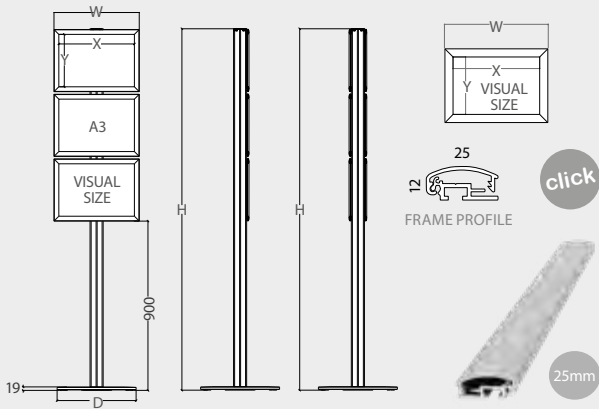

* W: Width H: Height D: Depth * mm



INFORMATION



Sign displays can be used in a variety of indoor locations to showcase eye-catching graphics and signage. These sign displays are equipped with click frames which let you display A3 graphics (antireflection protector included). If you choose the configuration of single-sided, you can display 3x A3-sized graphics. Also you can create a double-sided presentation by attaching your sign holders back to back and exposing 6x A3-sized graphics. Guadalupe info stands are made of aluminum and feature a smooth silver finish.

GUADALUPE A3 SINGLE * W: Width H: Height D: Depth

	QTY	N.W	G.W	C.B.M	Size (WxHxD)	
Packing	1	2.8kg	3.6kg	0.0123	80x1920x80mm	 x5 
	1	8.2kg	8.5kg	0.0097	440x440x50mm	
	3	0.65kg	0.85kg	0.0061	365x480x35mm	
	Visual (X-Y)		External (WxHxD)			
Product	278x401mm		453x1922x Ø420mm			

10.155 Graphic Size: A3 x 3uni.

GUADALUPE A3 DOUBLE * W: Width H: Height D: Depth

	QTY	N.W	G.W	C.B.M	Size (WxHxD)	
Packing	1	2.8kg	3.6kg	0.0123	80x1920x80mm	 x8 
	1	8.2kg	8.5kg	0.0097	440x440x50mm	
	6	0.65kg	0.85kg	0.0061	365x480x35mm	
	Visual (X-Y)		External (WxHxD)			
Product	278x401mm		453x1922x Ø420mm			

10.157 Graphic Size: A3 x 6uni.

GUADALUPE A3





STAND DETAILS

SIZES * W: Width H: Height D: Depth * mm

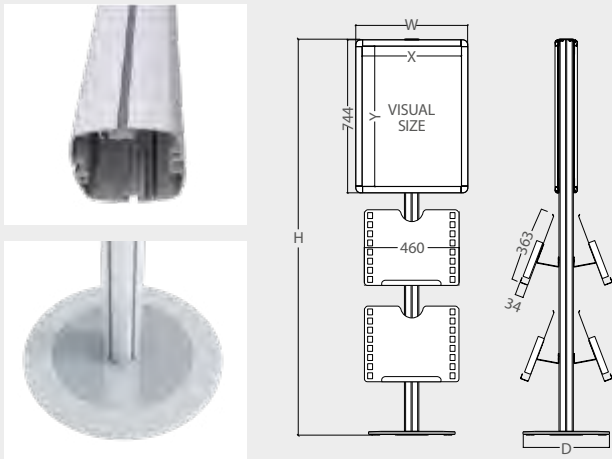

INFORMATION

The Combi Stand consists of an aluminium pole profile, a solid 8kg steel base and multiple possible configurations to choose from, featuring the number of literature holders trays (1-8 units available), the possibility of incorporating one or more upper Click system frames with antireflex cover (there are different sizes and also, 2-sided design available). All Combi Stand models are supplied in complete Kits. The Combi Stands are ideal for being used in trade shows, lobby areas, for museums, hotel lobbies, shopping malls, gymnasiums or for the airports.

COMBI STAND

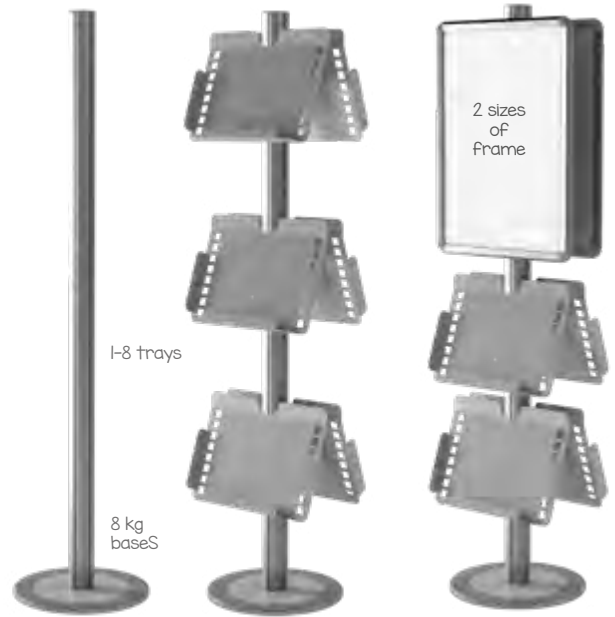

COMBI ONE

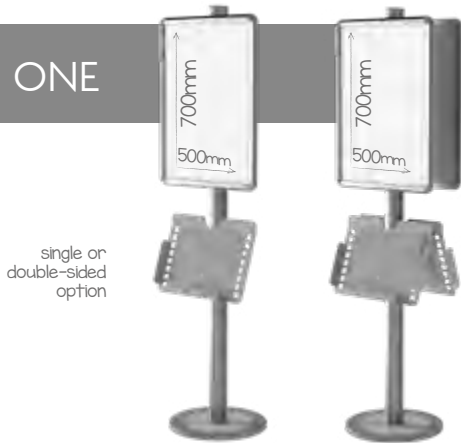

single or double-sided option

COMBI TWO

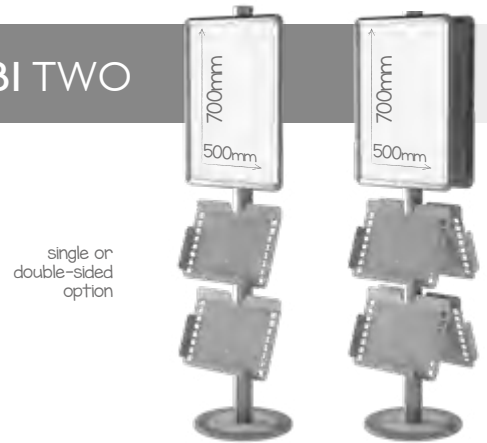

single or double-sided option

COMBI ONE 1SIDED * W: Width H: Height D: Depth

	QTY	N.W	G.W	C.B.M	Size (WxHxD)	
Packing	1	2.8kg	3.6kg	0.0123	80x1920x80mm	 x4
	1	8.2kg	8.5kg	0.0097	440x440x50mm	
	1	1.95kg	2.2kg	0.0089	380x470x50mm	
	1	1.95kg	2.4kg	0.0104	560x745x25mm	
	Visual (X-Y)		External (WxHxD)			
Product	481x681mm		544x1922xØ420mm			

10.479 Graphic Size: 500x700mm

COMBI ONE 2SIDED * W: Width H: Height D: Depth

	QTY	N.W	G.W	C.B.M	Size (WxHxD)	
Packing	1	2.8kg	3.6kg	0.0123	80x1920x80mm	 x6
	1	8.2kg	8.5kg	0.0097	440x440x50mm	
	2	1.95kg	2.2kg	0.0089	380x470x50mm	
	2	1.95kg	2.4kg	0.0104	560x745x25mm	
	Visual (X-Y)		External (WxHxD)			
Product	481x681mm		544x1922xØ420mm			

10.480 Graphic Size: 500x700mm (x2)

COMBI TWO 1SIDED * W: Width H: Height D: Depth

	QTY	N.W	G.W	C.B.M	Size (WxHxD)	
Packing	1	2.8kg	3.6kg	0.0123	80x1920x80mm	 x5
	1	8.2kg	8.5kg	0.0097	440x440x50mm	
	2	1.95kg	2.2kg	0.0089	380x470x50mm	
	1	1.95kg	2.4kg	0.0104	560x745x25mm	
	Visual (X-Y)		External (WxHxD)			
Product	481x681mm		544x1922xØ420mm			

10.485 Graphic Size: 500x700mm

COMBI TWO 2SIDED * W: Width H: Height D: Depth

	QTY	N.W	G.W	C.B.M	Size (WxHxD)	
Packing	1	2.8kg	3.6kg	0.0123	80x1920x80mm	 x8
	1	8.2kg	8.5kg	0.0097	440x440x50mm	
	4	1.95kg	2.2kg	0.0089	380x470x50mm	
	2	1.95kg	2.4kg	0.0104	560x745x25mm	
	Visual (X-Y)		External (WxHxD)			
Product	481x681mm		544x1922xØ420mm			

10.486 Graphic Size: 500x700mm (x2)



COMBI THREE

single or double-sided option





COMBI THREE 1SIDED

* W: Width H: Height D: Depth

	QTY	N.W	G.W	C.B.M	Size (WxHxD)	
Packing	1	2.8kg	3.6kg	0.0123	80x1920x80mm	 x5 
	1	8.2kg	8.5kg	0.0097	440x440x50mm	
	3	1.95kg	2.2kg	0.0089	380x470x50mm	
	External (WxHxD)					
Product	460x1922xØ420mm					
10.483						

COMBI THREE 2SIDED

* W: Width H: Height D: Depth

	QTY	N.W	G.W	C.B.M	Size (WxHxD)	
Packing	1	2.8kg	3.6kg	0.0123	80x1920x80mm	 x8 
	1	8.2kg	8.5kg	0.0097	440x440x50mm	
	6	1.95kg	2.2kg	0.0089	380x470x50mm	
	External (WxHxD)					
Product	544x922xØ420mm					
10.484						



COMBI FOUR

single or double-sided option





COMBI FOUR 1SIDED

* W: Width H: Height D: Depth

	QTY	N.W	G.W	C.B.M	Size (WxHxD)	
Packing	1	2.8kg	3.6kg	0.0123	80x1920x80mm	 x6 
	1	8.2kg	8.5kg	0.0097	440x440x50mm	
	4	1.95kg	2.2kg	0.0089	380x470x50mm	
	External (WxHxD)					
Product	544x1922xØ420mm					
10.481						

COMBI FOUR 2SIDED

* W: Width H: Height D: Depth

	QTY	N.W	G.W	C.B.M	Size (WxHxD)	
Packing	1	2.8kg	3.6kg	0.0123	80x1920x80mm	 x10 
	1	8.2kg	8.5kg	0.0097	440x440x50mm	
	8	1.95kg	2.2kg	0.0089	380x470x50mm	
	External (WxHxD)					
Product	544x1922xØ420					
10.482						

COMBI MIX

single or double-sided option

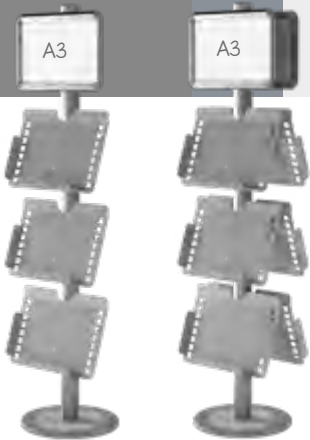

COMBI MIX 1SIDED

* W: Width H: Height D: Depth

	QTY	N.W	G.W	C.B.M	Size (WxHxD)	
Packing	1	2.8kg	3.6kg	0.0123	80x1920x80mm	 x6 
	1	8.2kg	8.5kg	0.0097	440x440x50mm	
	3	1.95kg	2.2kg	0.0089	380x470x50mm	
	1	1kg	1.2kg	0.0061	365x480x35mm	
	Visual (X-Y)		External (WxHxD)			
Product	481x681mm		544x1922xØ420mm			
10.487	Graphic Size: A3					

COMBI MIX 2SIDED

* W: Width H: Height D: Depth

	QTY	N.W	G.W	C.B.M	Size (WxHxD)	
Packing	1	2.8kg	3.6kg	0.0123	80x1920x80mm	 x10 
	1	8.2kg	8.5kg	0.0097	440x440x50mm	
	6	1.95kg	2.2kg	0.0089	380x470x50mm	
	2	1kg	1.2kg	0.0061	365x480x35mm	
	Visual (X-Y)		External (WxHxD)			
Product	278x402mm		460x1922xØ420mm			
10.488	Graphic Size: A3 (x2)					

COMBI FRAME

single or double-sided option



COMBI FRAME 1SIDED

* W: Width H: Height D: Depth

	QTY	N.W	G.W	C.B.M	Size (WxHxD)	
Packing	1	2.8kg	3.6kg	0.0123	80x1920x80mm	 x4 
	1	8.2kg	8.5kg	0.0097	440x440x50mm	
	2	1.95kg	2.4kg	0.0104	560x745x25mm	
	Visual (X-Y)		External (WxHxD)			
Product	481x681mm		544x1922xØ420mm			
10.489	Graphic Size: 500x700					

COMBI FRAME 2SIDED

* W: Width H: Height D: Depth

	QTY	N.W	G.W	C.B.M	Size (WxHxD)	
Packing	1	2.8kg	3.6kg	0.0123	80x1920x80mm	 x6 
	1	8.2kg	8.5kg	0.0097	440x440x50mm	
	4	1.95kg	2.4kg	0.0104	560x745x50mm	
		Visual (X-Y)		External (WxHxD)		
Product	481x681mm		544x1922xØ420mm			
10.490	Graphic Size: 500x700 (x2)					

STAND DETAILS



DIMENSIONS

* W: Width H: Height D: Depth * mm

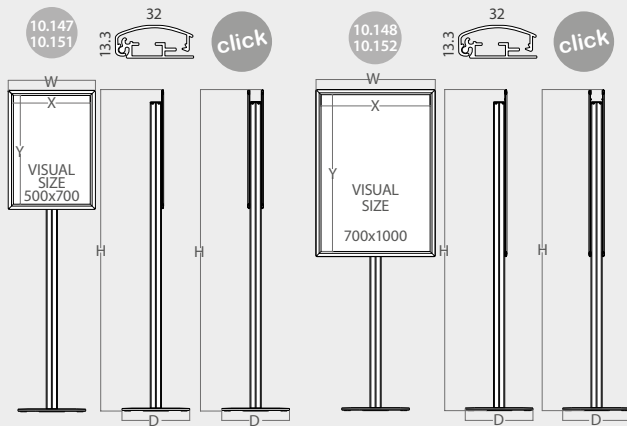

INFORMATION



Sign displays can be used in a variety of indoor locations to showcase eye-catching graphics and signage. It features a 8kg weight steel base and click system frame. Simply flip open the frames' molding and slide your graphics behind the non-glare protector. These sign displays are made of aluminum and feature a smooth silver finish and comes with antireflection protector. Also double-sided presentation is available.

PLASENCIA



PLASENCIA H700



* W: Width H: Height D: Depth

	QTY	N.W	G.W	C.B.M	Size (WxHxD)	
Packing	1	2.8kg	3.6kg	0.0123	80x1920x80mm	 x3 
	1	8.2kg	8.5kg	0.0097	440x440x50mm	
	1	1.5kg	2kg	0.0104	560x745x25mm	
	Visual (X-Y)		External (WxHxD)			
Product	478x678mm		540x1922x Ø420mm			

10.147 Graphic Size: 500x700mm x 1uni.

PLASENCIA H1000



* W: Width H: Height D: Depth

	QTY	N.W	G.W	C.B.M	Size (WxHxD)	
Packing	1	2.8kg	3.6kg	0.0123	80x1920x80mm	 x3 
	1	8.2kg	8.5kg	0.0097	440x440x50mm	
	1	2.55kg	3.25kg	0.0210	780x1075x25mm	
	Visual (X-Y)		External (WxHxD)			
Product	678x978mm		740x1922x Ø420mm			

10.148 Graphic Size: 700x1000mm x 1uni.

PLASENCIA H700 DOUBLE



* W: Width H: Height D: Depth

	QTY	N.W	G.W	C.B.M	Size (WxHxD)	
Packing	1	2.8kg	3.6kg	0.0123	80x1920x80mm	 x4 
	1	8.2kg	8.5kg	0.0097	440x440x50mm	
	2	1.5kg	2kg	0.0104	560x745x25mm	
	Visual (X-Y)		External (WxHxD)			
Product	478x678mm		540x1922x Ø420mm			

10.151 Graphic Size: 500x700mm x 2uni.

PLASENCIA H1000 DOUBLE

* W: Width H: Height D: Depth

	QTY	N.W	G.W	C.B.M	Size (WxHxD)	
Packing	1	2.8kg	3.6kg	0.0123	80x1920x80mm	 x4 
	1	8.2kg	8.5kg	0.0097	440x440x50mm	
	2	2.55kg	3.25kg	0.0210	780x1075x25mm	
	Visual (X-Y)		External (WxHxD)			
Product	678x978mm		740x1922x Ø420mm			

10.152 Graphic Size: 700x1000mm x 2uni.

TOTEM DETAILS



DIMENSIONS

* W: Width H: Height D: Depth * mm

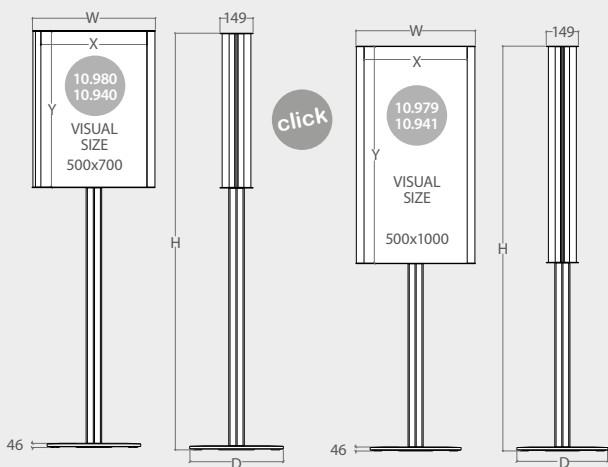

INFORMATION

Leinster double-sided display is built from sturdy easy-to-use snap aluminum frame with edge-lit LED bulbs. Useful for darker venues, such as halls and movie theaters. The convex holder with antireflection protector helps graphics pop out, ensuring that the double sided poster display can be seen from any angle. Designed for day or night time use. It is also available without light.

LEINSTER



LEINSTER H700

* W: Width H: Height D: Depth

	QTY	N.W	G.W	C.B.M	Size (WxHxD)	
Packing	1	18.75kg	21.3kg	0.1202	1095x610x180mm	 x2
	1	8.2kg	8.5kg	0.009	440x440x50mm	
Product	Visual (X-Y)		External (WxHxD)			
	476x700mm		552x1868x Ø420mm			
10.980	Graphic Size: 500x700mm					



LEINSTER H1000

* W: Width H: Height D: Depth

	QTY	N.W	G.W	C.B.M	Size (WxHxD)	
Packing	1	18.75kg	21.3kg	0.1202	1095x610x180mm	 x2
	1	8.20kg	8.5kg	0.009	440x440x50mm	
Product	Visual (X-Y)		External (WxHxD)			
	476x1000mm		552x1868x Ø420mm			
10.979	Graphic Size: 500x1000mm					



LEINSTER H700 LED

* W: Width H: Height D: Depth

	QTY	N.W	G.W	C.B.M	Size (WxHxD)	
Packing	1	18.75kg	21.3kg	0.1202	1095x610x180mm	 x2 
	1	8.2kg	8.5kg	0.009	440x440x50mm	
Product	Visual (X-Y)		External (WxHxD)			
	476x700mm		552x1868x Ø420mm			
10.940	Graphic Size: 500x700mm					

LEINSTER H1000 LED

* W: Width H: Height D: Depth

	QTY	N.W	G.W	C.B.M	Size (WxHxD)	
Packing	1	18.75kg	21.3kg	0.1202	1095x610x180mm	 x2 
	1	8.20kg	8.5kg	0.009	440x440x50mm	
Product	Visual (X-Y)		External (WxHxD)			
	476x1000mm		552x1868x Ø420mm			
10.941	Graphic Size: 500x1000mm					

TOTEM DETAILS



DIMENSIONS

* W: Width H: Height D: Depth * mm

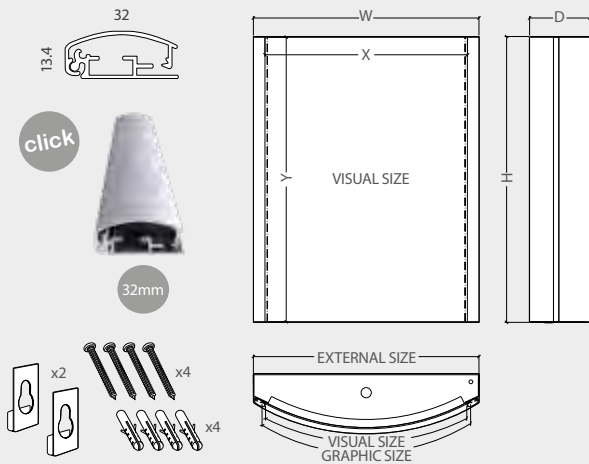

INFORMATION

Genova Light Totem features a high quality anodized aluminum poster frame along with an accompanying satin metal base. Its Click System allows an easy and quick poster change. The poster holder display, which is a curved sign holder, includes antireflection protector and also features backlit LED illumination. The illuminated lightbox stand has clear PVC lens to prevent glare. Ideal for using at hospitals, clinics, darker halls or movie theaters.

GENOVA LIGHT TOTEM



GENOVA 700 LED

* W: Width H: Height D: Depth

	QTY	N.W	G.W	C.B.M	Size (WxHxD)
Packing	1	9.4kg	10.9kg	0.0918	600x765x200mm
	Visual (X-Y)		External (WxHxD)		
Product	518x707mm		710x560x150mm		
10.117	Visual: 500x700mm		Graphic Size: 539x707mm		

GENOVA 1000 LED

* W: Width H: Height D: Depth

	QTY	N.W	G.W	C.B.M	Size (WxHxD)
Packing	1	15.05kg	17.45kg	0.1758	805x1065x205mm
	Visual (X-Y)		External (WxHxD)		
Product	712x1000mm		760x1010x150mm		
10.348	Visual: 700x1000mm		Graphic Size: 734x1007mm		

TOTEM DETAILS



DIMENSIONS

* W: Width H: Height D: Depth * mm

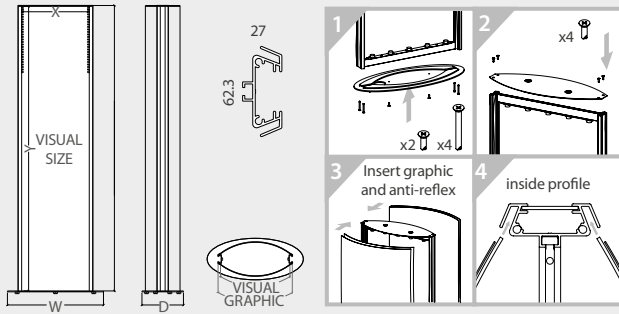

INFORMATION

Obidos double-sided Totem is built from sturdy, durable silver anodized aluminum with a steel base and antireflection protector. Designed with a convex display and bright illumination for day or night use (PVC lens to prevent glare are included). Ideal for restaurants, clinics, academies, darker halls, shopping malls or movie theaters. Anti-reflective plastic included.

OBIDOS H1600

* W: Width H: Height D: Depth

	QTY	N.W	G.W	C.B.M	Size (WxHxD)	
Packing	1	9.46kg	11.70kg	0.1078	570x1645x115mm	 x2
	1	5.30kg	5.65kg	0.0054	565x275x35mm	
		Visual (X-Y)		External (WxHxD)		
Product		488x1600mm		540x1610x234mm		
10.221	Totem: 500x1600mm		Graphic Size: 516x1600mm			

OBIDOS H1800

* W: Width H: Height D: Depth

	QTY	N.W	G.W	C.B.M	Size (WxHxD)	
Packing	1	13.20kg	16.10kg	0.14	660x1845x115mm	 x2
	1	6.05kg	6.45kg	0.0072	665x310x35mm	
		Visual (X-Y)		External (WxHxD)		
Product		602x1800mm		640x1810x277mm		
10.222	Totem: 600x1800mm		Graphic Size: 630x1800mm			

OBIDOS
LIGHT TOTEM



OBIDOS H2000

* W: Width H: Height D: Depth

	QTY	N.W	G.W	C.B.M	Size (WxHxD)	
Packing	1	16kg	19.40kg	0.1764	750x2045x115mm	 x2
	1	10kg	10.50kg	0.0095	765x355x35mm	
		Visual (X-Y)		External (WxHxD)		
Product		703x2000mm		740x2010x320mm		
10.223	Totem: 700x2000mm		Graphic Size: 731x2000mm			

TOTEM DETAILS



with /
without
LED

INFORMATION

* W: Width H: Height D: Depth * mm

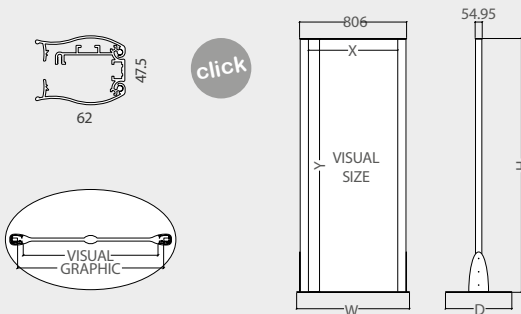

Cascais double-sided Totem is built from sturdy silver anodized aluminum with steel base and anti-reflex protector. Designed for day or night time use, the illuminated lightbox stand has clear PVC lens to prevent glare. This Totem is freestanding and is very well suited as display frame for advertising in retail locations, restaurants, clinics or exhibitions. Cascais lightbox stand is useful for darker halls or movie theaters.

CASCAIS

* W: Width H: Height D: Depth

	QTY	N.W	G.W	C.B.M	Size (WxHxD)	
Packing	1	19.25kg	21.9kg	0.1579	850x1955x95mm	
	1	14.85kg	15.75kg	0.0213	875x540x45mm	
	Visual (X-Y)		External (WxHxD)			
Product	672x1900mm		850x1910x500mm			
10.356	Totem: 700x1900mm		Graphic Size: 728x1900mm			

CASCAIS LED

* W: Width H: Height D: Depth

	QTY	N.W	G.W	C.B.M	Size (WxHxD)	
Packing	1	20.45kg	23.1kg	0.1579	850x1955x95mm	
	1	14.85kg	15.75kg	0.0213	875x540x45mm	
	Visual (X-Y)		External (WxHxD)			
Product	672x1900mm		850x1910x500mm			
10.354	Totem: 700x1900mm		Graphic Size: 728x1900mm			

CASCAIS LIGHT TOTEM



TOTEM DETAILS



INFORMATION

* W: Width H: Height D: Depth * mm

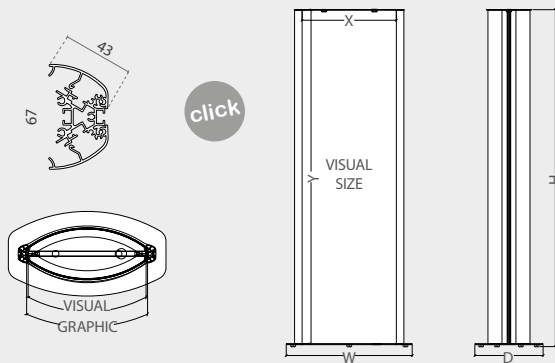

The Nantes Totem is built from sturdy, durable silver anodized aluminum with steel base. Designed for day or night time use (PVC lens included). Antireflection protector included. Ideal for restaurants, clinics, darker halls or movie theaters.

NANTES LIGHT TOTEM



NANTES H1200

* W: Width H: Height D: Depth

	QTY	N.W	G.W	C.B.M	Size (WxHxD)	
Packing	1	8.25kg	10.1kg	0.0816	570x1245x115mm	x2
	1	7.65kg	8.65kg	0.0077	620x355x35mm	
	Visual (X-Y)		External (WxHxD)			
Product	485x1200mm		600x1217x325mm			

10.602 Totem: 500x1200mm Graphic: 524x1200mm

NANTES H1600

* W: Width H: Height D: Depth

	QTY	N.W	G.W	C.B.M	Size (WxHxD)	
Packing	1	9.5kg	11.45kg	0.1078	570x1645x115mm	x2
	1	7.65kg	8.65kg	0.0077	620x355x35mm	
	Visual (X-Y)		External (WxHxD)			
Product	485x1600mm		600x1617x325mm			

10.436 Totem: 500x1600mm Graphic: 524x1600mm

NANTES H1800

* W: Width H: Height D: Depth

	QTY	N.W	G.W	C.B.M	Size (WxHxD)	
Packing	1	14.6kg	17kg	0.14	660x1845x115mm	x2
	1	9.95kg	11.05kg	0.0101	720x400x35mm	
	Visual (X-Y)		External (WxHxD)			
Product	588x1800mm		700x1817x370mm			

10.460 Totem: 600x1800mm Graphic: 626x1800mm

NANTES W700xH1800

* W: Width H: Height D: Depth

	QTY	N.W	G.W	C.B.M	Size (WxHxD)	
Packing	1	15.95kg	18.55kg	0.1570	740x1845x115mm	x2
	1	13.4kg	14.55kg	0.0132	820x460x35mm	
	Visual (X-Y)		External (WxHxD)			
Product	695x1800mm		800x1817x427mm			

10.521 Totem: 700x1800mm Graphic: 724x1800mm

NANTES H1200 LED

* W: Width H: Height D: Depth

	QTY	N.W	G.W	C.B.M	Size (WxHxD)	
Packing	1	9.35kg	11.2kg	0.0816	570x1245x115mm	x2
	1	7.65kg	8.65kg	0.0077	620x355x35mm	
	Visual (X-Y)		External (WxHxD)			
Product	485x1200mm		600x1217x325mm			

10.402 Totem: 500x1200mm Graphic: 524x1200mm

NANTES H1600 LED

* W: Width H: Height D: Depth

	QTY	N.W	G.W	C.B.M	Size (WxHxD)	
Packing	1	10.5kg	12.45kg	0.1078	570x1645x115mm	x2
	1	7.65kg	8.65kg	0.0077	620x355x35mm	
	Visual (X-Y)		External (WxHxD)			
Product	485x1600mm		600x1617x325mm			

10.464 Totem: 500x1600mm Graphic: 524x1600mm

NANTES 1800 LED

* W: Width H: Height D: Depth

	QTY	N.W	G.W	C.B.M	Size (WxHxD)	
Packing	1	15.6kg	18kg	0.14	660x1845x115mm	x2
	1	9.95kg	11.05kg	0.0101	720x400x35mm	
	Visual (X-Y)		External (WxHxD)			
Product	588x1800mm		700x1817x370mm			

10.465 Totem: 600x1800mm Graphic: 626x1800mm

NANTES W700xH1800 LED

* W: Width H: Height D: Depth

	QTY	N.W	G.W	C.B.M	Size (WxHxD)	
Packing	1	16.95kg	19.55kg	0.1570	740x1845x115mm	x2
	1	13.4kg	14.55kg	0.0132	820x460x35mm	
	Visual (X-Y)		External (WxHxD)			
Product	695x1800mm		800x1817x427mm			

10.556 Totem: 700x1800mm Graphic: 724x1800mm

TOTEM DETAILS



DIMENSIONS

* W: Width H: Height D: Depth * mm

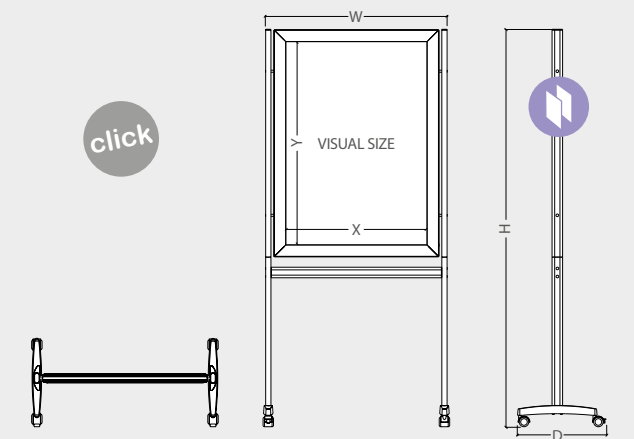

INFORMATION

Designed for day or night time use, Sintra Info Stand is built from sturdy, durable aluminum frame, with a 32mm width Click System profile and edge-lit LED bulbs. Also, it has 'brake wheels' and a resistant antireflection protector. Ideal for tradeshows, medical clinics, academies, highly-populated lobbies, travel agencies, darker venues, movie theaters, libraries or for waiting rooms.

SINTRA		* W: Width	H: Height	D: Depth	
	QTY	N.W	G.W	C.B.M	Size (WxHxD)
Packing	1	16.5kg	19.95kg	0.01455	920x140x1130mm
	Visual (X-Y)	External (WxHxD)			
Product	683x983mm		900x1925x430mm		
10.313	Graphic Size: 700x1000mm				

SINTRA



SINTRA LED LIGHT		* W: Width	H: Height	D: Depth	
	QTY	N.W	G.W	C.B.M	Size (WxHxD)
Packing	1	20.35kg	22.7kg	0.01455	920x140x1130mm
	Visual (X-Y)	External (WxHxD)			
Product	683x983mm		900x1925x430mm		
10.767	Graphic Size: 700x1000mm				

TOTEM DETAILS



INFORMATION

* W: Width H: Height D: Depth * mm

Almendralejo Info Totem is designed to be used with brochure advertising. It has a 32mm width profile with click system. Also Resistant antireflection protectors and brake wheels. Ideal for use in tradeshows, clinics, highly-populated lobbies, academies, travel agencies, libraries, shopping malls or waiting rooms to provide reading material to clients.

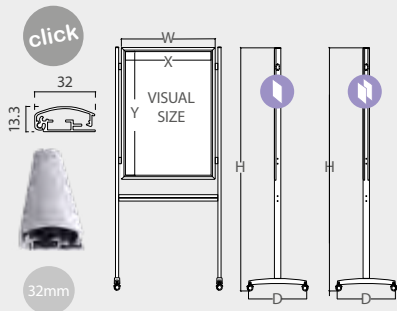

BROCHURE HOLDERS OPTIONS

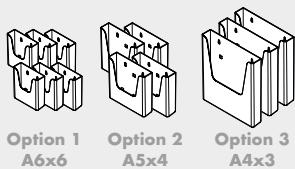

You can choose between 3 options to set-up your brochure holders:

- 6 Brochure Holders A6 size format.
- 4 Brochure Holders A5 size format.
- 3 Brochure Holders A4 size format.

ALMENDRALEJO

* W: Width H: Height D: Depth

	QTY	N.W	G.W	C.B.M	Size (WxHxD)	
Packing	1	8.6kg	10.9kg	0.1258	860x1950x75mm	
		Visual (X-Y)	External (WxHxD)			
Product	677x977mm		834x1920x460mm			
10.160	Graphic Size: 700x1000mm					

ALMENDRALEJO 2-SIDED

* W: Width H: Height D: Depth

	QTY	N.W	G.W	C.B.M	Size (WxHxD)	
Packing	1	10.3kg	13.5kg	0.1258	860x1950x75mm	
		Visual (X-Y)	External (WxHxD)			
Product	677x977mm		834x1920x460mm			
10.759	Graphic Size: 700x1000mm					

ALMENDRALEJO





TOTEM DETAILS



DIMENSIONS

* W: Width H: Height D: Depth * mm

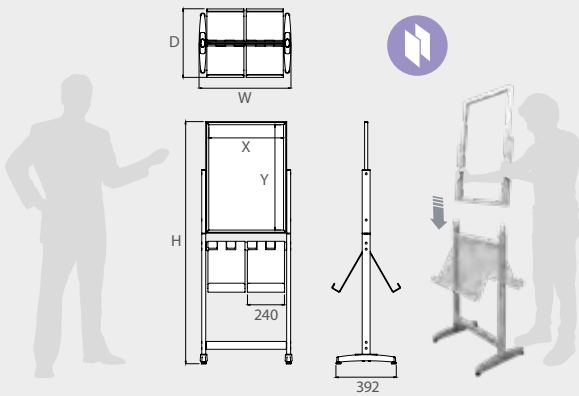

INFORMATION

The Double-sided Polan Info Stand is made of aluminium. There are two available models: without shelves (Ref: 13.862) and with 4 acrylic shelves for 4x A4 format literature documents (Ref: 13.599) like brochures, magazines, or newspapers. Also it features an aluminium frame header at the top. With adjustable leveling feet and an easy glide for the graphic poster (9mm maximum thickness) into the metal grooves of the structure and display it back-to-back.

POLAN WITHOUT SHELVES

* W: Width H: Height D: Depth

	QTY	N.W	G.W	C.B.M	Size (WxHxD)
Packing	1	4.41kg	5.67kg	0.0614	880x665x105mm
		Visual (X-Y)	External (WxHxD)		
Product		485x683mm	596.5x1569x446mm		
13.862	Top Header Graphic Size: 500x700mm				

POLAN WITH SHELVES

* W: Width H: Height D: Depth

	QTY	N.W	G.W	C.B.M	Size (WxHxD)
Packing	1	6.77kg	8.47kg	0.0614	880x665x105mm
		Visual (X-Y)	External (WxHxD)		
Product		485x683mm	596.5x1569x446mm		
13.599	Top Header Graphic Size: 500x700mm				

POLAN



TOTEM DETAILS



INFORMATION *mm

Cañada is made of aluminium with 4 acrylic shelves for A4 documents. It features a double-sided large poster holder. Perfect for using in highly populated lobbies, travel agencies, libraries or for waiting rooms to provide reading material to the clients, also thanks to its LED Light, it's ideal for darker halls or movie theaters.

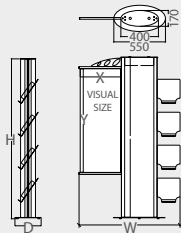

CAÑADA * W: Width H: Height D: Depth

	QTY	N.W	G.W	C.B.M	Size (WxHxD)
Packing	1	18.5kg	19.7kg	0.3752	652x345x1740mm
		Visual (X-Y)	External (WxHxD)		
Product	Totem: 308x1699mm		1074x1700x280mm		
	Totem: 430x1109mm				
10.470	Totem Graphic Size: 324x1700mm Poster Graphic Size: 430x1100mm				

CAÑADA



double sided



4x A4 holders

made of aluminium and acrylic supports

TOTEM DETAILS



INFORMATION *mm

Hito is made of silver finish aluminium with 3 acrylic shelves for A4 documents. It features a solid and stable 8kg weight steel base and a double-sided large poster holder. Ideal for using in highly populated lobbies, travel agencies, libraries or for waiting rooms to provide reading material to the visiting clients.

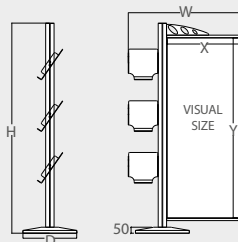

HITO * W: Width H: Height D: Depth

	QTY	N.W	G.W	C.B.M	Size (WxHxD)
Packing	1	2.8kg	3.6kg	0.0123	80x1920x80mm
	1	8.2kg	8.5kg	0.0097	440x440x50mm
	1	1.6kg	1.9kg	0.0190	390x650x75mm
	Visual (X-Y)	External (WxHxD)			
Product	600x1500mm		930x1753x450mm		
10.471	Graphic Size: 600x1510mm				

HITO



3x A4 holders

double faced

8 kg steel base

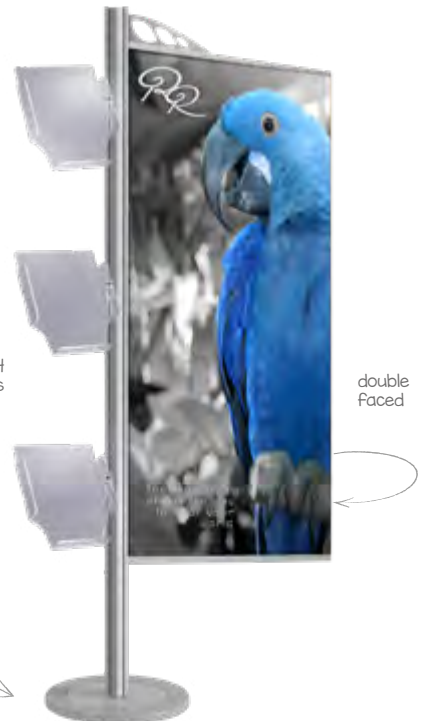

STAND DETAILS



INFORMATION

*mm

Cañamo has wheels and it is made of aluminium with acrylic shelves. The 1-sided model has 4 shelves for 8x4A4 documents and 2-sided: 8 shelves for 16x4A4 documents, like brochures, journals or newspapers. Ideal for using in highly-populated lobbies, travel agencies, libraries or waiting rooms to provide literature for clients.

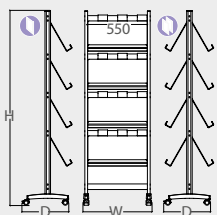

CAÑAMO

* W: Width H: Height D: Depth

	QTY	N.W	G.W	C.B.M	Size (WxHxD)	
Packing	1	7.3kg	9kg	0.0487	165x720x410mm	 x2
	1	6.45kg	8.05kg	0.0772	70x1750x630mm	
		External (WxHxD)				
Product		629x1769x487mm				
10.468		1-Sided (8x4A)				
14.098		2-Sided (16x4A)				

CAÑAMO



made of acrylic and aluminium

2 sided available



brake wheels



STAND DETAILS



INFORMATION

*mm

Abad has wheels and it is made of aluminium with acrylic shelves. The 1-sided model has 4 shelves for 8x4A4 documents and 2-sided: 8 shelves for 16x4A4 documents. Also it has a "Click" frame header at the top. Ideal for using in highly-populated lobbies, travel agencies, libraries or waiting rooms to provide literature for clients.

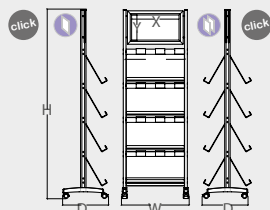

ABAD

* W: Width H: Height D: Depth

	QTY	N.W	G.W	C.B.M	Size (WxHxD)	
Packing	1	7.3kg	9kg	0.0487	165x720x410mm	 x2
	1	6.45kg	8.05kg	0.0772	70x1750x630mm	
		Visual (X-Y)		External (WxHxD)		
Product		466x236mm		629x1769x487mm		
10.467		Top Header Graphic Size: 488x257mm				
14.099		Top Headers Graphic Size: 488x257mm (x2)				

ABAD



- EN With a "Click" aluminium header frame at the top.
- FR Avec un cadre "Click" dans la partie supérieure.
- PT Possui um marco "Click" na parte superior.
- ES Dispone de un marco "Click" en su parte superior.

2 sided available



brake wheels



LITERATURE STAND Literature Stands

STAND DETAILS



INFORMATION

*mm

Sotillo Stand is made of aluminium with 4 acrylic shelves for 12x4 documents. It features a "Click" frame header at the top. Also It is equipped with 4 brake wheels. Ideal for using in highly-populated lobbies, travel agencies, libraries or for waiting rooms to provide reading material to the clients.

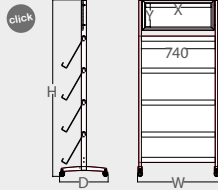

SOTILLO

* W: Width H: Height D: Depth

	QTY	N.W	G.W	C.B.M	Size (WxHxD)	
Packing	1	9kg	10.5kg	0.062	410x920x165mm	 x2
	1	7.35kg	9.35kg	0.101	830x1750x70mm	
Product		Visual (X-Y)	External (WxHxD)			
		656x236mm	819x1769x487mm			
10.469	Graphic Size: 677x257mm					

SOTILLO



- EN With a "Click" aluminium header frame at the top.
- FR Avec un cadre "Click" dans la partie supérieure.
- PT Possui um marco de abertura "Click" na parte superior.
- ES Dispone de un marco "Click" en su parte superior.

For 12x4 documents

made of acrylic and aluminium

brake wheels



STAND DETAILS



INFORMATION

*mm

Olmedilla is made of aluminium with 1 acrylic shelf for 3x4 documents ref. 10.273 and 2x4 documents ref. 10.472. It features a 2-sided "Click" frame board (2 sizes available). Also It has 4 brake wheels. Ideal for using in highly populated lobbies, travel agencies, libraries or for waiting rooms to provide reading material to the clients.

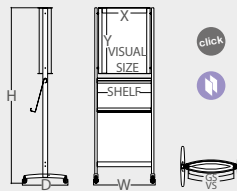

OLMEDILLA H700

* W: Width H: Height D: Depth

	QTY	N.W	G.W	C.B.M	Size (WxHxD)	
Packing	1	11.5kg	13.4kg	0.243	1825x205x650mm	 x2
		Visual (X-Y)	External (WxHxD)		Shelf capacity	
Product		476x696mm	655x1864x487mm		2x4A	
10.472	Top Header Graphic Size: 500x700mm					

OLMEDILLA H1000

* W: Width H: Height D: Depth

	QTY	N.W	G.W	C.B.M	Size (WxHxD)	
Packing	1	17kg	18.5kg	0.372	850x1825x240mm	 x2
		Visual (X-Y)	External (WxHxD)		Shelf capacity	
Product		690x996mm	856x1864x487mm		3x4A	
10.273	Top Header Graphic Size: 700x1000mm					

OLMEDILLA



- EN With a "Click" aluminium header frame at the top.
- FR Avec un cadre "Click" dans la partie supérieure.
- PT Possui um marco de abertura "Click" na parte superior.
- ES Dispone de un marco "Click" en su parte superior.

double sided

made of acrylic and aluminium

brake wheels



STAND DETAILS



INFORMATION

*mm

The Verona Brochure stand is made of aluminium with acrylic shelves and it has 4 shelves for A4 format documents. Also it has a top acrylic header for a 255x147mm graphic. It is ideal for using in highly populated lobbies, at travel agencies, libraries or for waiting rooms to provide reading material to the visiting clients.

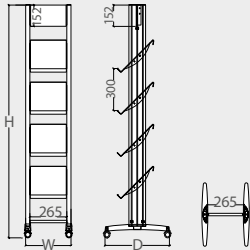

VERONA 4x4

* W: Width H: Height D: Depth

	QTY	N.W	G.W	C.B.M	Size (WxHxD)	
Packing	1	3kg	3.95kg	0.0307	420x430x170mm	 x2
	1	4.45kg	5kg	0.0118	145x1620x80mm	
	External (WxHxD)					
Product	325x1660x380mm					
10.217	Top Header Graphic Size: 255x147mm					

VERONA 4x4



with acrylic header at the top

with 4x4 brochures



brake wheels



STAND DETAILS

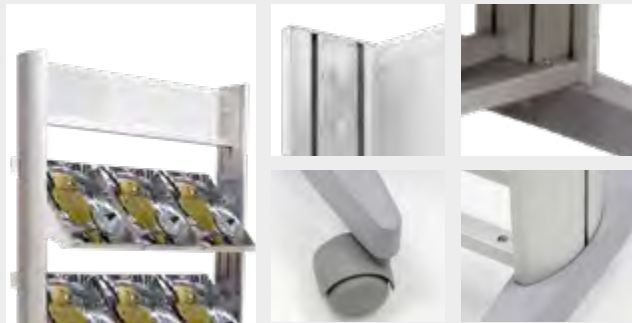

INFORMATION

*mm

Verona Stand is made of aluminium with acrylic shelves. This model has 4 shelves for 12 xA4 format documents. Also it has a top acrylic header for a 730x147mm graphic and wheels. Ideal for using in highly-populated lobbies, travel agencies, libraries or for waiting rooms to provide reading material to the visiting clients.

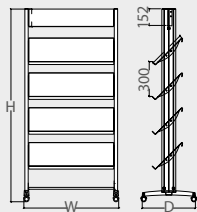

VERONA 12x4

* W: Width H: Height D: Depth

	QTY	N.W	G.W	C.B.M	Size (WxHxD)	
Packing	1	3kg	3.95kg	0.0307	420x430x170mm	 x2
	1	4.45kg	5kg	0.0188	145x1620x80mm	
	External (WxHxD)					
Product	800x1660x380mm					
10.218	Top Header Graphic Size: 730x147mm					

VERONA 12x4



made of acrylic and aluminium

with 12x4 brochures



brake wheels



STAND DETAILS



DIMENSIONS

* W: Width H: Height D: Depth * mm

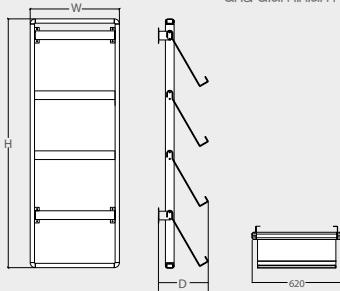

made of acrylic and aluminium

INFORMATION

Athy Brochure Wall Holder has 4 shelves and it is designed to accommodate 2xA4 portrait format documents by shelf. The magazine rack is wall mounting, giving you more floor space while still providing passersby with information. This type of rack system allows you to adjust the literature holders to the size you need. In this manner, it is up and out of your way, while remaining at eye level for your customers. Athy Holder is ideal for an office or lobby. Also see it in waiting rooms to hold your magazines and newspapers, or in information centers, travel bureaus and clinics to hold your brochures.

ATHY * W: Width H: Height D: Depth

	QTY	N.W	G.W	C.B.M	Size (WxHxD)
Packing	1	11.7kg	13.4kg	0.1742	185x1500x650mm
					External (WxHxD)
Product					620x1450x290mm
10.988					

ATHY

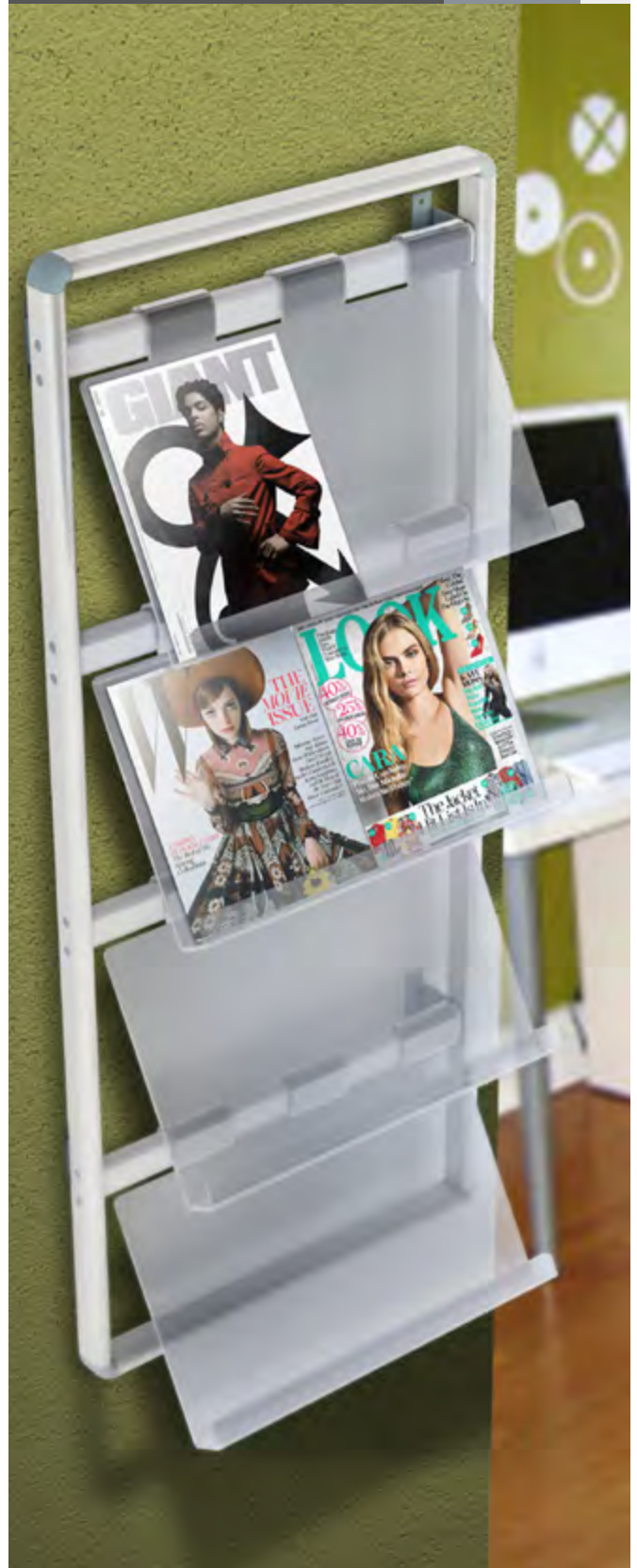

STAND DETAILS



DIMENSIONS

* W: Width H: Height D: Depth * mm

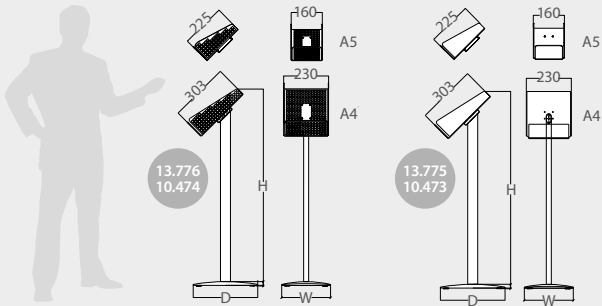

INFORMATION

The Sagres brochure tray stand features acrylic or steel literature holder (depending on model) available for A4 or A5 format documents, an aluminium profile structure with a highly resistant and solid base, which ensures that the unit stays upright in heavily trafficked areas. The silver finish provides a neutral tone that will complement any commercial environment. Ideal for tradeshows, mall stores, exhibitions or places with a high traffic area.

SAGRES METALLIC

* W: Width H: Height D: Depth

	QTY	N.W	G.W	C.B.M	Size (WxHxD)
Packing	1	3.2kg	3.5kg	0.0322	295x120x910mm
	External (WxHxD)				
Product	± 250x1000x330mm				
13.776	Brochure Holder Size: A5				
10.474	Brochure Holder Size: A4				

SAGRES ACRYLIC

* W: Width H: Height D: Depth

	QTY	N.W	G.W	C.B.M	Size (WxHxD)
Packing	1	3.1kg	3.4kg	0.0322	295x120x910mm
	External (WxHxD)				
Product	± 250x1000x330mm				
13.775	Brochure Holder Size: A5				
10.473	Brochure Holder Size: A4				

SAGRES LECTERN



LITERATURE STAND Literature Stands

STAND DETAILS



DIMENSIONS

* W: Width H: Height D: Depth * mm

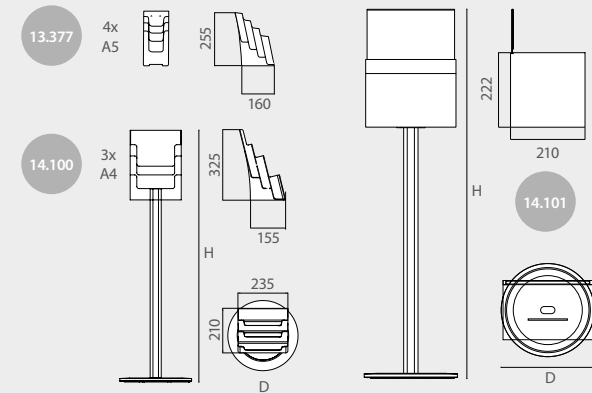

INFORMATION

* W: Width H: Height D: Depth * mm

This Holder Stand features 2 model design: The Brochure Holder has 2 dispenser sizes available: A4 (3 pockets) or A5 format (4 pockets) for displaying documents like brochures, flyers, or catalogues. The BallotBox model is designed for gathering customer feedback, complaints, ideas or contests. Both models has a solid 5kg base with 2 decorative interchangeable extra covers (included). The acrylic brochure holder arrives in a separate box from the base and pole stand. These floorstanding leaflet dispenser are also ideal for special promotions at various events, like tradeshows, hotels information, restaurants, retailers, corporate events or places with a high traffic area.

LEAFLET STAND

* W: Width H: Height D: Depth

	QTY	N.W	G.W	C.B.M	Size (WxHxD)	
Packing	1	5kg	5.3kg	0.0055	350x35x45mm	x3
	1	0.70kg	0.85kg	0.0035	895x65x37mm	
	1	1.1kg	1.5kg	0.0194	330x230x260mm	
External (HxD)						
Product	1170xØ330mm					
13.777	Leaflet Dispenser Size: A5					
14.100	Leaflet Dispenser Size: A4					

BALLOT BOX

* W: Width H: Height D: Depth

	QTY	N.W	G.W	C.B.M	Size (WxHxD)	
Packing	1	5kg	5.3kg	0.0055	350x350x45mm	x3
	1	0.70kg	0.85kg	0.0035	895x65x37mm	
	1	1.7kg	2.4kg	0.0332	380x265x330mm	
External (HxD)						
Product	1323xØ330mm					
14.101						

BROCHURE & BALLOTBOX FREESTAND



STAND DETAILS



INFORMATION

*mm

Mentrida features a stable design with a black finish to easily match any environment. Featuring a top header and a front bottom area for graphics. It also organizes and displays your magazines in an orderly manner with an open-front design for customers. Mentrida Stand features 5 pockets for displaying A4 portrait format documents. Ideal for travel magazines, real estate booklets, autos-for-sale publications, bussiness catalogues and also great for use at libraries, schools, hospitals or doctors' offices.



MENTRIDA

* W: Width H: Height D: Depth

	QTY	N.W	G.W	C.B.M	Size (WxHxD)
Packing	1	4.2kg	5.1kg	0.0565	120x1520x310mm
		External (WxHxD)			
Product	250x1465x470mm				
10.720					

MENTRIDA

5x A4 portrait pockets

made in black painted steel

the bottom can be used to place a graphic



STAND DETAILS



INFORMATION

*mm

The Nelas Brochure Stand is made of lightweight and durable wire and it is designed for an easy rotation and quick selection of literature. With 21 pockets for displaying A4 portrait format documents. Featuring 5 swivel castors for an easy and comfortable transport. These displays are great for use at libraries, schools, offices, trade shows, exhibitions, travel agencies, waiting rooms, retail outlets or showroom floors.

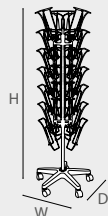

NELAS

* W: Width H: Height D: Depth

	QTY	N.W	G.W	C.B.M	Size (WxHxD)
Packing	1	8kg	10.05kg	0.203	530x320x1200mm
		External (WxHxD)			
Product	510x1550x510mm				
13.101					

NELAS

21x A4 portrait pockets

made of steel and plastic parts

easy rotation



STAND DETAILS

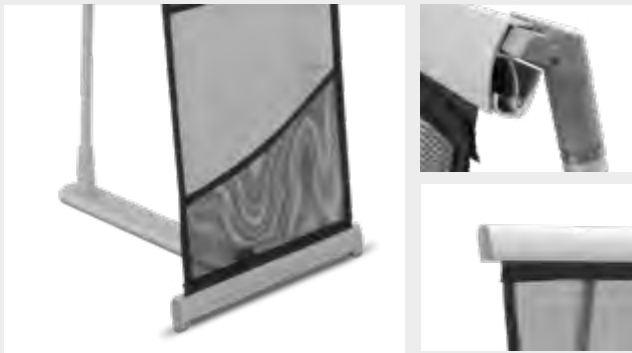

INFORMATION

Sil Brochure Stand is perfect for exhibitors who need a lightweight and portable display for their tradeshow booth. This magazine stand is made of black mesh and has 4 pockets for A4 Portrait format documents. Featuring an elastic design to the pockets that keeps reading materials secure and erect while on display. Includes carrying-bag.

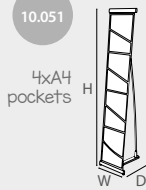

SIL SIMPLE

* W: Width H: Height D: Depth

	QTY	N.W	G.W	C.B.M	Size (WxHxD)
Packing	1	1.05kg	1.20kg	0.0086	120x600x120mm
	External (WxHxD)				
Product	270x1360x380mm				
10.051	4 x A4 Pockets				

SIL

4x A4 pockets

made of nylon and aluminium



STAND DETAILS



INFORMATION

Sil Double Brochure Stand is perfect for exhibitors who need a lightweight and portable display for their tradeshow booth. This magazine stand is made of black mesh and has 8 pockets for A4 Portrait format documents. Featuring an elastic design to the pockets that keeps reading materials secure and erect while on display. Includes carrying-bag.

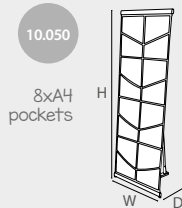

SIL DOUBLE

* W: Width H: Height D: Depth

	QTY	N.W	G.W	C.B.M	Size (WxHxD)
Packing	1	1.4kg	1.55kg	0.0086	120x600x120mm
	External (WxHxD)				
Product	545x1360x380mm				
10.050	8 x A4 Pockets				

SIL DOUBLE

8x A4 pockets

made of nylon and aluminium



STAND DETAILS



with header top for customizing with logo

INFORMATION

*mm

Bari features a strong and stable design and it is made of steel with a silver finish to easily match any environment. Featuring a top holder for 2x44 max. wide documents. Perfect for displaying in an orderly manner with an open-front design for customers. Bari is ideal for displaying travel magazines, real estate booklets, autos-for-sale publications, catalogues and other types of literature.

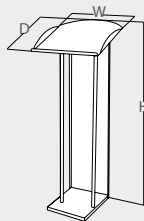

BARI

* W: Width H: Height D: Depth

	QTY	N.W	G.W	C.B.M	Size (WxHxD)
Packing	1	8.6kg	11kg	0.3125	500x1250x500mm
		External (WxHxD)			
Product	455x1210x450mm				
10.219					

BARI

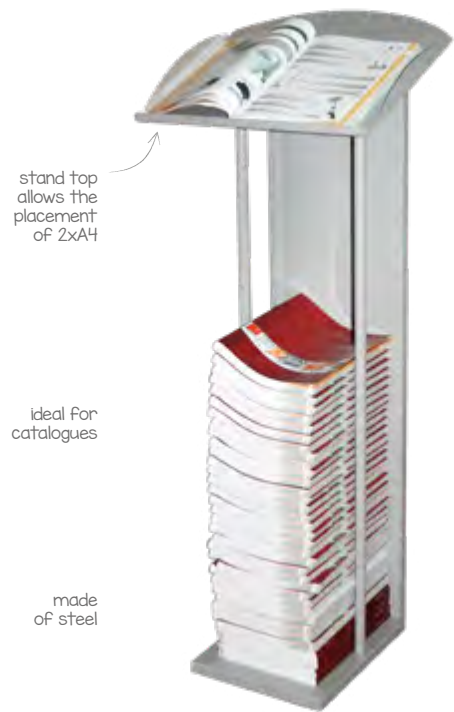

stand top allows the placement of 2x44

ideal for catalogues

made of steel

STAND DETAILS

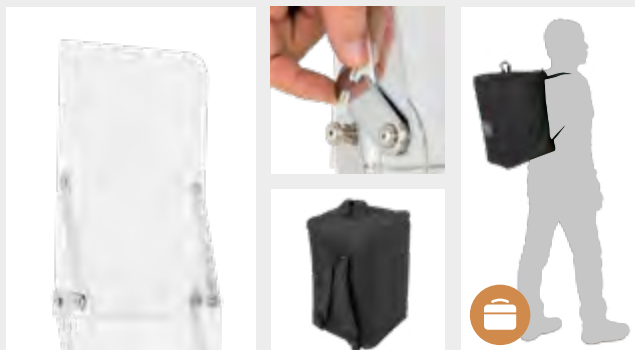

INFORMATION

*mm

Vegas Brochure Stand offers the look and stability of a permanent fixture and the versatility of a portable stand. Featuring 4x44 format pockets. This foldable silver tradeshow literature rack can be stored with pamphlets and magazines in the pockets, even when the unit is collapsed and stowed away. Set up is simple, just taking the unit out of the carrying bag and pulling the pockets upward. Ideal for conventions, tradeshows, exhibitions, media events or places with a high traffic area.



VEGAS

* W: Width H: Height D: Depth

	QTY	N.W	G.W	C.B.M	Size (WxHxD)
Packing	1	6kg	8kg	0.067	380x470x380mm
		External (WxHxD)			
Product	280x1605x260mm				
10.048					

VEGAS



4x44 portrait acrylic shelves



Foldable

STAND DETAILS



INFORMATION

*mm

Soubran is designed to be mobile and compact. In this model it features 5 portrait steel pockets for A4 portrait format documents. This tradeshow literature rack can be stored with magazines in the pockets, even when the unit is folded and stowed away. With a front bottom space to place a graphic and a carry-bag. Ideal for trade shows, conventions, exhibitions, retail outlets or showroom floors to attract customers looking for additional information.

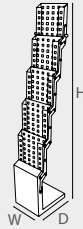

SOUBRAN

* W: Width H: Height D: Depth

	QTY	N.W	G.W	C.B.M	Size (WxHxD)
Packing	1	8kg	10kg	0.148	550x770x350mm
		External (WxHxD)			
Product		230x1420x290mm			
10.416					

SOUBRAN

5x A4 portrait steel shelves

steel structure

the bottom can be used to place a graphic



STAND DETAILS



INFORMATION

*mm

Colmenar is designed to be mobile and compact. In this model it features 5 portrait acrylic pockets for A4 portrait format documents. This tradeshow literature rack can be stored with magazines in the pockets, even when the unit is folded and stowed away. With a front bottom space for graphic and a nylon carry-bag. Ideal for trade shows, conventions, exhibitions, retail outlets or showroom floors to attract customers looking for additional information.

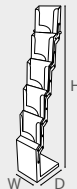

COLMENAR

* W: Width H: Height D: Depth

	QTY	N.W	G.W	C.B.M	Size (WxHxD)
Packing	1	5kg	7kg	0.148	550x770x350mm
		External (WxHxD)			
Product		230x1420x290mm			
13.718					

COLMENAR

5x A4 portrait acrylic shelves

steel structure

the bottom can be used to place a graphic



STAND DETAILS



DIMENSIONS

* W: Width H: Height D: Depth * mm

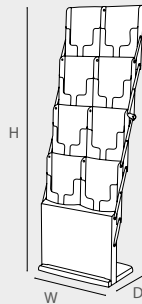

INFORMATION

*mm

The combination of contemporary design, durability and portability make Legnica one of the best options for literature displaying. With front bottom for adding graphics and 8 pockets for A4 portrait documents. Easy to unfold and fold., its design allows you to leave literature inside the pockets when the unit is folded. Includes nylon carry bag for a simple transportation. Ideal for travel magazines, real estate booklets, autos-for-sale publications, bussiness catalogues and also great for libraries, schools, hospitals, tradeshows, promotion areas or showroom floors.

LEGNICA

* W: Width H: Height D: Depth

	QTY	N.W	G.W	C.B.M	Size (WxHxD)
Packing	1	14.4kg	15.5kg	0.109	355x570x540mm
		External (WxHxD)			
Product	480x1560x300mm				
10.114	Nylon Travel Bag				

LEGNICA



STAND DETAILS



DIMENSIONS

* W: Width H: Height D: Depth * mm

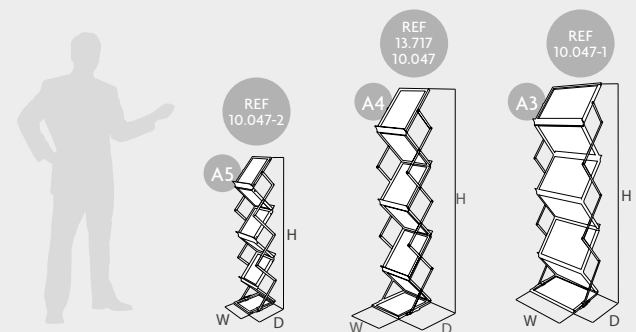

INFORMATION

Sahagun is designed to be mobile and compact. It has a zigzag design that folds down into a small unit and lightweight thanks to its aluminium structure and acrylic holders. Featuring A3, A4 or A5 format literature holders that provide a multi-level display system with an unobstructed view of documents you wish to display. For a simple transportation you can choose between the nylon carry-bag or the deluxe briefcase option, which has reinforced foam padded.

SAHAGUN A3 * W: Width H: Height D: Depth

	QTY	N.W	G.W	C.B.M	Size (WxHxD)
Packing	1	9kg	10kg	0.041	540x480x160mm
Product	External (WxHxD)				
	480x1500x350mm				

10.047-1 Briefcase

SAHAGUN A4 * W: Width H: Height D: Depth *mm

	QTY	N.W	G.W	C.B.M	Size (WxHxD)
Packing	1	5kg	5.8kg	0.0162	430x290x130
Product	External (WxHxD)				
	260x1490x350				

13.717 Nylon Travel Bag

10.047 Briefcase

SAHAGUN A5 * W: Width H: Height D: Depth

	QTY	N.W	G.W	C.B.M	Size (WxHxD)
Packing	1	4kg	5kg	0.021	370x280x200mm
Product	External (WxHxD)				
	220x1010x260mm				

10.047-2 Briefcase

SAHAGUN



HOLDER DETAILS



DIMENSIONS

* mm

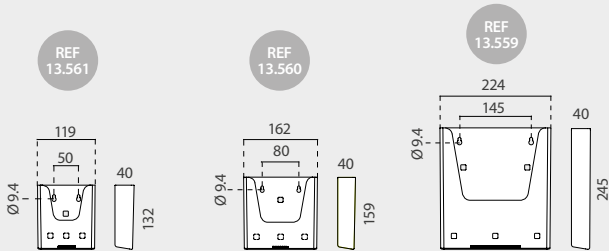



ACCESSORIES COMBINATIONS (NEXT PAGE)



INFORMATION

This acrylic Brochure Holder features 3 sizes: A6, A5 or A4 formats. Built with pre-drilled holes, suitable for being used with suction cups, base feet or for wall mounting with proper accessories (see next page). Rounded pocket fronts give this display a stylish appearance and its acrylic is optically clear.

DISPENSER	COMPARTMENTS	COMPARTMENT SIZE		
13.561	1	A6	x10 	
13.560	1	A5	x10 	
13.559	1	A4	x10 	

SINGLE BROCHURE HOLDER



REF 13.499

HANGER DETAILS



INFORMATION

*mm

Acrylic Brochure Holder for A6 leaflet size. Double magnet fixing system. No tools required. Ideal for any Roll Up.



MAGNET DISPENSER	QTY	N.W.	G.W.	C.B.M.	SIZE	
Packing	5	0.85kg	0.95kg	0.004	165x130x215mm	
10.860	Graphic Size: A6				x5 	

MAGNETIC BROCHURE HOLDER

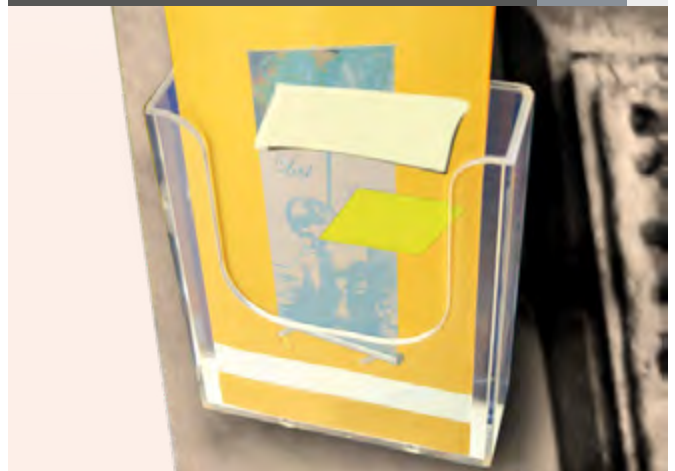

BASE FEET DETAILS

DIMENSIONS

* mm



INFORMATION

Base feet made of acrylic with transparent appearance, they are designed for being used with brochure holders. Possibility of using one or two bases according to holder model. Ideal for making a desktop use. Sold in packs of 20 units.

BASE FEET	SIZE	
13.499	45x17x89mm	x20 

BASE FEET FOR BROCHURE HOLDER



SUCTION CUPS DETAILS

DIMENSIONS

* mm

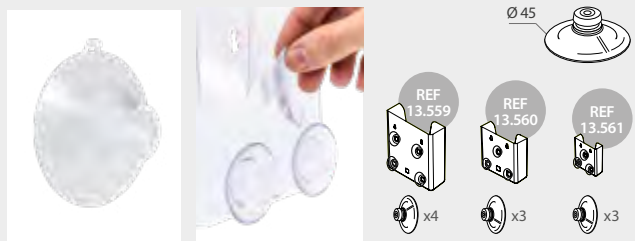

INFORMATION

These Suction Cups give a reinforced adhesion to your brochure holders thanks to their double suction. Possibility of using 3 or 4 suction cups according to holder model. Ideal for making a wall mounted use. Sold in packs of 100 units.

SUCTION CUPS	DIAMETER	
12.171	Ø45mm	x100 

DOUBLE SUCTION CUP FOR BROCHURE HOLDER



HANGER DETAILS





INFORMATION

DIMENSIONS

* mm

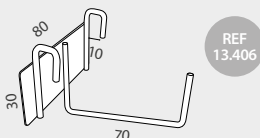
This Hanger is made of metal and it has 3 hooks. It is suitable for being used with leaflet dispensers on shelves. Sold in packs of 10 units.



HANGER	SIZE	
13.406	80x30x70mm	x10 

SHELF HANGER FOR BROCHURE HOLDER



* Wall holders at this page are available but not included.

HOLDER DETAILS



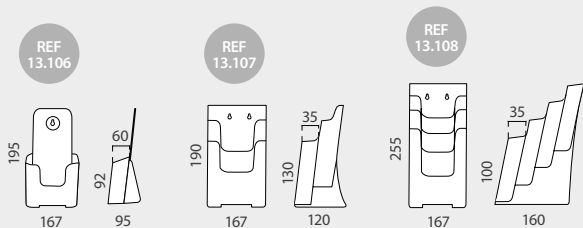

DIMENSIONS

* mm



INFORMATION

This Brochure Holder features an A5 format size and 3 models, depending of its compartments. These literature holders, also known as leaflet displays, pamphlet dispensers, are ideal for distributing your free promotional literature. Built with pre-drilled holes, this literature rack can be wall mounted to ensure that customers will be able to see your promotional material while they browse your gift shop or wait in your lobby. Also, the compact design of this display helps keep your table tops and counters neat and organized. Rounded pocket fronts give this economy display a slightly stylish appearance and its acrylic is optically clear.

1x A5	COMPARTMENTS	COMPARTMENT SIZE		
13.106	1	A5	x4	
2x A5	COMPARTMENTS	COMPARTMENT SIZE		
13.107	2	A5	x4	
4x A5	COMPARTMENTS	COMPARTMENT SIZE		
13.108	4	A5	x2	

TRANSPARENT A5 BROCHURE HOLDER



HOLDER DETAILS



DIMENSIONS

* mm

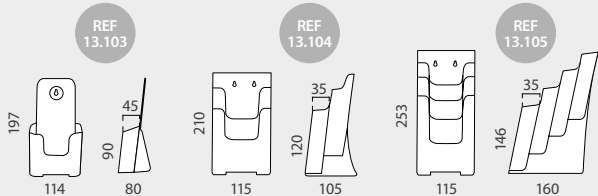

INFORMATION

This Brochure Holder features a 1/3 of A4 format size and 3 models, depending of its compartments. Built with pre-drilled holes, this literature rack can be wall mounted. Compact design and rounded pocket fronts give this economy display a stylish appearance and its acrylic is optically clear.

1x 1/3 A4	COMPARTMENTS	COMPARTMENT SIZE		
13.103	1	1/3 A4	x6	
2x 1/3 A4	COMPARTMENTS	COMPARTMENT SIZE		
13.104	2	1/3 A4	x4	
4x 1/3 A4	COMPARTMENTS	COMPARTMENT SIZE		
13.105	4	1/3 A4	x2	

TRANSPARENT 1/3 A4 BROCHURE HOLDER



HOLDER DETAILS



INFORMATION

This Brochure Holder features a double 1/3 of A4 format. Rounded pocket fronts give this economy display a stylish appearance and its acrylic is optically clear.

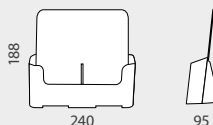

DOUBLE 1/3 A4	COMPARTMENTS	COMPARTMENT SIZE		
13.834	2	1/3 A4	x4	

TRANSPARENT DOUBLE 1/3 A4 BROCHURE HOLDER



HOLDER DETAILS



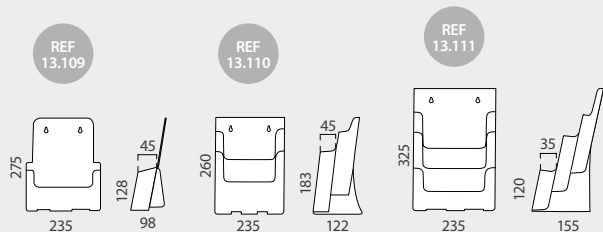

DIMENSIONS

* mm



INFORMATION

This Brochure Holder features an A4 format size and 3 models, depending of its compartments. These literature holders, also known as leaflet displays, pamphlet dispensers, are ideal for distributing your free promotional literature. Built with pre-drilled holes, this literature rack can be wall mounted to ensure that customers will be able to see your promotional material while they browse your gift shop or wait in your lobby. Also, the compact design of this display helps keep your table tops and counters neat and organized. Rounded pocket fronts give this economy display a slightly stylish appearance and its acrylic is optically clear.

1x A4	COMPARTMENTS	COMPARTMENT SIZE		
13.109	1	A4	x4	
2x A4	COMPARTMENTS	COMPARTMENT SIZE		
13.110	2	A4	x2	
3x A4	COMPARTMENTS	COMPARTMENT SIZE		
13.111	3	A4	x2	

TRANSPARENT A4 BROCHURE HOLDER



HOLDER DETAILS

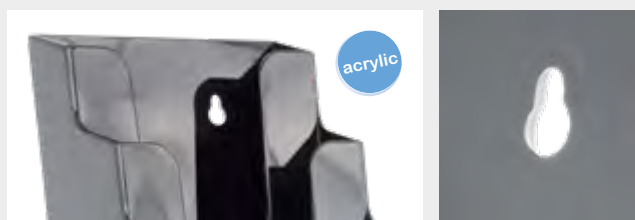

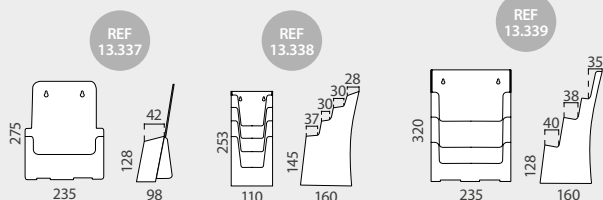

DIMENSIONS

*mm



INFORMATION

These three models of dispensers are made of black colored plastic. Suitable for use them over countertops or mounted on walls. Ideal for being used at retail stores, real estates, offices, hospitals or academies

BLACK	COMPARTMENTS	COMPARTMENT SIZE	
13.337	1	A4	x4 
13.338	4	1/3 A4	x2 
13.339	3	A4	x2 

BLACK BROCHURE HOLDER

countertop or wall
mount unit



HOLDER DETAILS

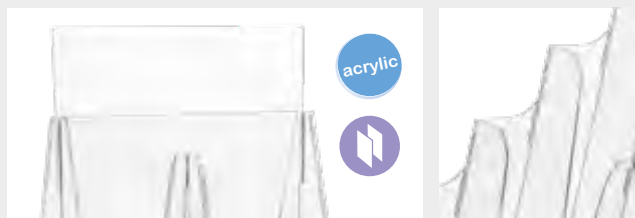

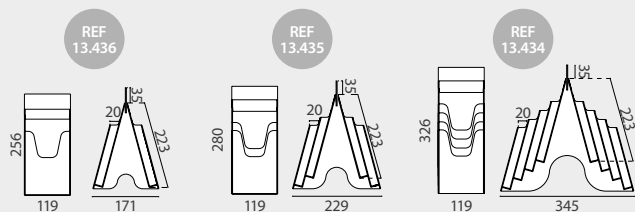

DIMENSIONS

*mm



INFORMATION

These three models of double-sided dispensers are made of transparent plastic. Suitable for use them over countertops. Ideal for being used at retail stores, real estates, offices, hospitals or academies

2-SIDED	COMPARTMENTS	COMPARTMENT SIZE	
13.436	1x2	1/3 A4	x4 
13.435	2x2	1/3 A4	x2 
13.434	4x2	1/3 A4	x2 

2-SIDED 1/3 A4 BROCHURE HOLDER

top advert
insert included

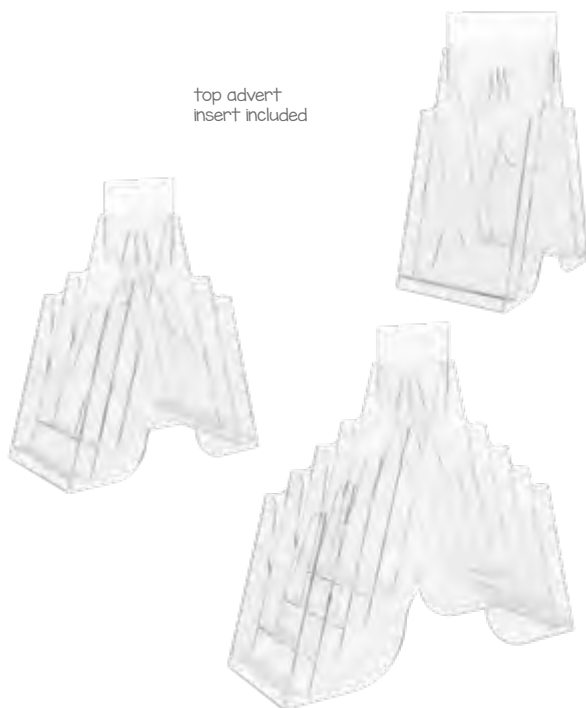





HOLDER DETAILS



INFORMATION

Desktop leaflet dispensers made of chromed wire. Suitable for A4 or 1/3 A4 documents. There are 4 models available. Features rubber feet to protect countertop surface. Ideal for being used at retail stores, offices or hospitals.

WIRE 1/3 A4	QTY	N.W	G.W	C.B.M	SIZE
Packing	1	0.25kg	0.45kg	0.004	135x140x220 mm
13.121	Graphic Size: 1/3 A4			x1 	
WIRE 4A	QTY	N.W	G.W	C.B.M	SIZE
Packing	1	0.35kg	0.55kg	0.01	270x150x270 mm
13.117	Graphic Size: 1x A4			x1 	
WIRE 4x 1/3 A4	QTY	N.W	G.W	C.B.M	SIZE
Packing	1	0.6kg	0.8kg	0.015	270x200x295 mm
13.120	Graphic Size: 4x 1/3 A4			x1 	
WIRE 3xA4	QTY	N.W	G.W	C.B.M	SIZE
Packing	1	0.7kg	0.9kg	0.029	270x230x470 mm
13.119	Graphic Size: 3x A4			x1 	

WIRE BROCHURE HOLDER



with rubber feet to protect countertop surface



HOLDER DETAILS

INFORMATION

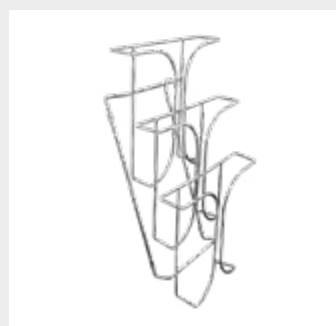

Wall leaflet dispensers made of chromed wire. Suitable for three A4 documents. Ideal for being used at retail stores, offices or hospitals.

WALL WIRE 3xA4	QTY	N.W	G.W	C.B.M	SIZE
Packing	1	0.65kg	0.85kg	0.027	270x230x450 mm
13.118	Graphic Size: 3x A4			x1 	

WALL WIRE BROCHURE HOLDER

wall unit



HOLDER DETAILS





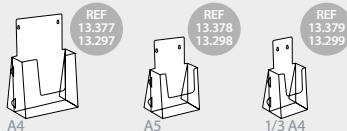

INFORMATION

These Dispensers are made of white or transparent PVC. Suitable for A4, A5 and 1/3 A4 format documents. Ideal for being used on desktops.



A4 A5 1/3 A4

L. CLEAR	COLOR	SIZE	THICKNESS		
13.377		A4	0.7mm	x10	
13.378		A5	0.7mm	x10	
13.379		1/3 A4	0.7mm	x10	
L. WHITE	COLOR	SIZE	THICKNESS		
13.297		A4	0.7mm	x10	
13.298		A5	0.7mm	x10	
13.299		1/3 A4	0.7mm	x10	

PVC BROCHURE HOLDER



HOLDER DETAILS

INFORMATION

*mm



This brochure holder is made of 0.6mm thickness PVC and is suitable for A6 size documents (or for 105mm maximum width documents). It is ideal for desktops.



105x141 A6	DOCUMENT	SIZE	THICKNESS		
13.063	A6	105x141mm	0.6mm	x30	

A6 PVC BROCHURE HOLDER



HOLDER DETAILS

INFORMATION

*mm



Brochure pocket is made of 0.4mm thickness PVC. It is suitable for coupons, calendars or documents with 98mm maximum width. It is ideal for desktops.

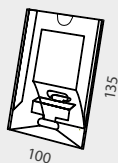

PVC POCKET	SIZE	THICKNESS		
13.432	100x135mm	0.4mm	x30	

POCKET PVC BROCHURE HOLDER



HOLDER DETAILS



DIMENSIONS

*mm

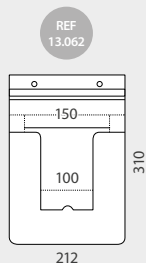
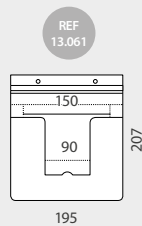
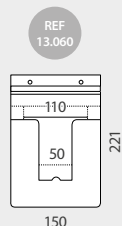

INFORMATION

This dispensers are made of 0.5mm thickness PVC. Suitable for A5 or A6 documents (from 110 to 150mm maximum width documents). They are excellent for fixing on shelf edges thank to its top adhesive strip.

DISPENSER	DOCUMENT	SIZE	THICKNESS	
13.060	A6	150x221mm	0.5mm	x30
13.061	A5-A6	195x207mm	0.5mm	x30
13.062	A5	212x310mm	0.5mm	x30

SHELF PVC BROCHURE HOLDER



HOLDER DETAILS

INFORMATION

*mm

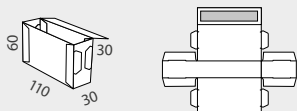

This dispenser, made of PVC with adhesive strip, is excellent for holding business cards or promotional coupons. Container external size: 110x60x30mm.

DISPENSER	SIZE	THICKNESS	
13.431	110x60x30mm	0.4mm	x30

COUPON CARD BROCHURE HOLDER



HOLDER DETAILS



DIMENSIONS

*mm

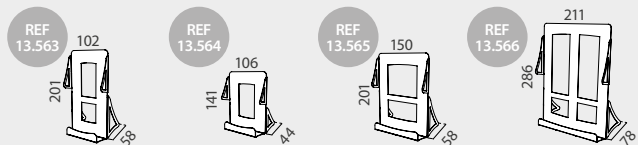

INFORMATION

Black Leaflet Holder made of metal and supplied flat for optimum storage. Featuring 4 sizes (1/3 A4, A6, A5 and A4 format). Quick and simple assembly, in only three steps and folding it with your hands is completely assembled.

METAL H. 1/3 A4	QTY	N.W	G.W	C.B.M	SIZE
Packing	1	0.78kg	0.88kg	0.0009	260x255x16 mm
13.563		Graphic Size: 1/3 A4		x4	

METAL H. A6	QTY	N.W	G.W	C.B.M	SIZE
Packing	1	0.6kg	0.65kg	0.0006	203x195x16 mm
13.564		Graphic Size: A6		x4	

METAL H. A5	QTY	N.W	G.W	C.B.M	SIZE
Packing	1	0.96kg	1.08kg	0.0011	276x255x16 mm
13.565		Graphic Size: A5		x4	

METAL H. A4	QTY	N.W	G.W	C.B.M	SIZE
Packing	1	1.59kg	1.79kg	0.002	375x340x16 mm
13.566		Graphic Size: A4		x4	

HAND FOLDED METAL HOLDER



STAND DETAILS



INFORMATION

* mm

This acrylic Rotating Stand is suitable for placing A4 format documents. Offered in black or white color. Also, available the Turntable Display (ref. 13.072).

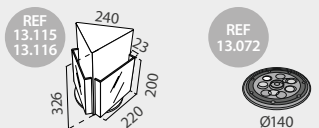



ROTATORY	COLOR	SIZE	
13.115		A4	x1
13.116		A4	x1

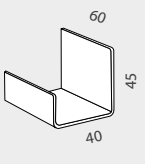

TURNTABLE	SIZE	
13.072	Ø140mm	x2

ROTATORY BROCHURE STAND



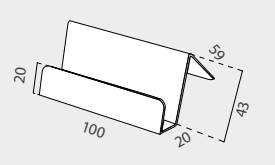

HOLDER DETAIL	INFORMATION	DIMENSIONS	*mm
	<p>This transparent Business Card Holder is made of 2mm thickness acrylic. It is ideal for displaying ID cards, directory signage, temporary notes... It is an excellent addition to any desktop. Featuring 3 models available.</p>		
A.HOLDER	SIZE	THICKNESS	
50.321	60x45x40mm	2mm	x20 



HOLDER DETAIL	DIMENSIONS	*mm
		
INFORMATION		
<p>This grey Business Card Holder is made of 1mm thickness metal. It is ideal for displaying ID cards, directory signage, little notebooks or just for temporary notes... This Card Holder is an excellent addition to any desktop.</p>		
METAL HOLDER	SIZE	THICKNESS
13.413	100x43x20mm	1mm
		x10 

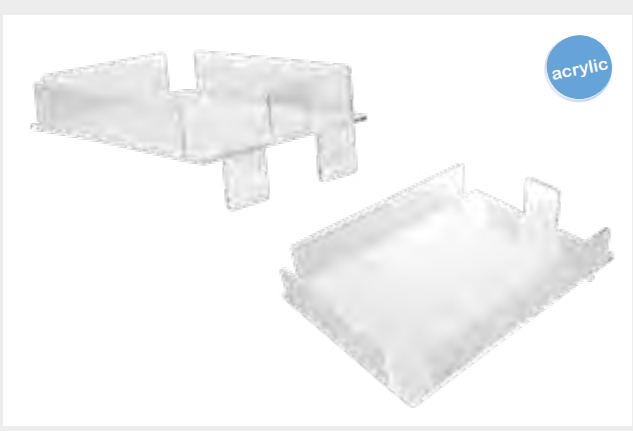
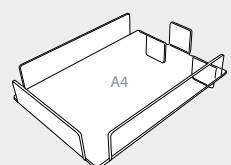

HOLDER DETAILS	INFORMATION		
			
INFORMATION			
<p>This desktop acrylic document tray holder is suitable for A4 format documents. It is made of 4mm thickness acrylic.</p>			
			
D.D.HOLDER	SIZE	THICKNESS	
13.405	A4	4mm	x2 

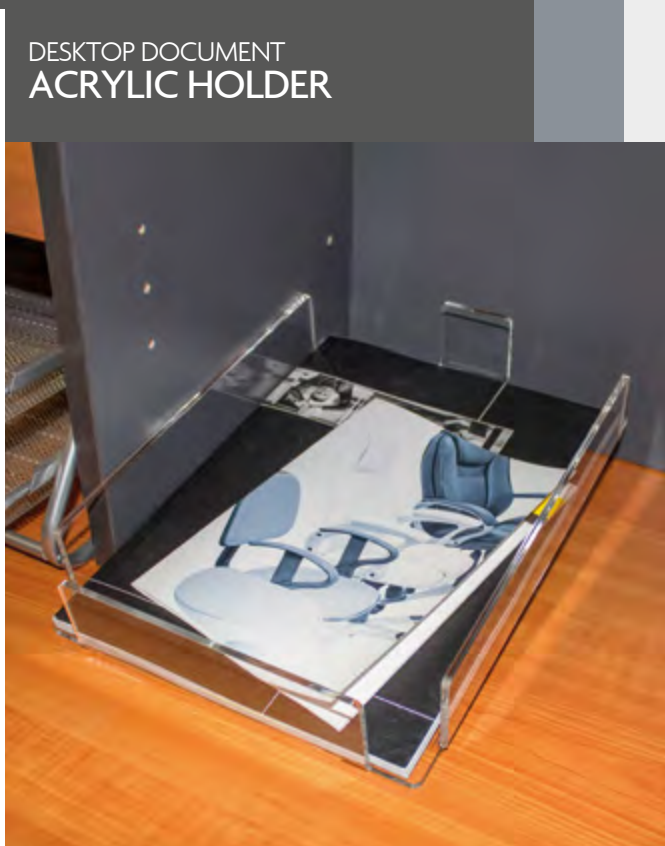

HOLDER DETAILS



INFORMATION

This Transparent Card Holder is made of 2mm thickness acrylic and it suitable for wall mounting. Thanks to its 6 pockets it is ideal for placing near a reception desk, beside an information point or just next to the entry door, keeping countertops clean and cards highly visible. Each compartment holds approximately 80 cards.

DIMENSIONS *mm

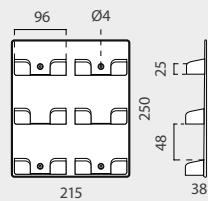

W.M.C.HOLDER	SIZE	THICKNESS	
13.439	250x38x215mm	2mm	x6 

POCKET LANDSCAPE WALL MOUNTED BUSINESS CARD HOLDER



HOLDER DETAILS



INFORMATION

This acrylic Wall Dispenser with portrait orientation has 2 holes at the top for wall mounting. With A4 and A5 format available.

REF 13.382

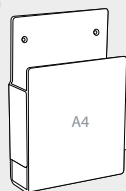

REF 13.383

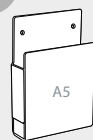

W.D.POCKET	SIZE	THICKNESS	
13.382	A4	4mm	x5 
13.383	A5	4mm	x5 

ACRYLIC POCKET WALL BROCHURE HOLDER



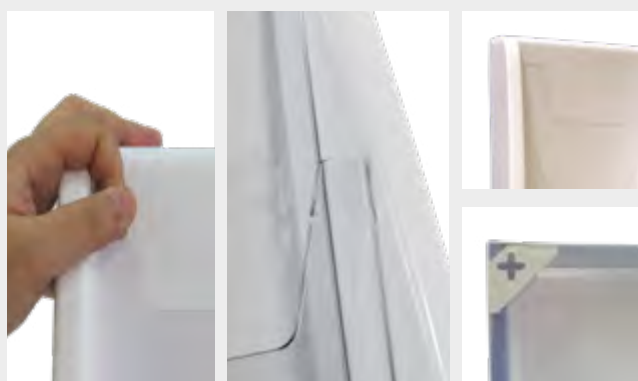

HOLDER DETAILS

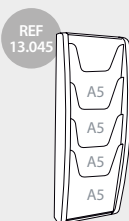
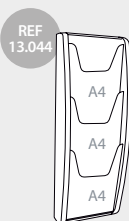

INFORMATION

This wall mount dispenser with portrait orientation white pockets features 2 options: with 3 pockets for A4 size documents or with 4 pockets for A5 size documents. It is ideal for displaying literature documents like flyers, promotions, magazines placed at waiting rooms.



POLYSTIRENE	GRAPHIC SIZE		
13.044	3x 4A	x1	
13.045	4x A5	x1	

WALL MOUNTED POLYSTIRENE DISPENSER



HOLDER DETAILS



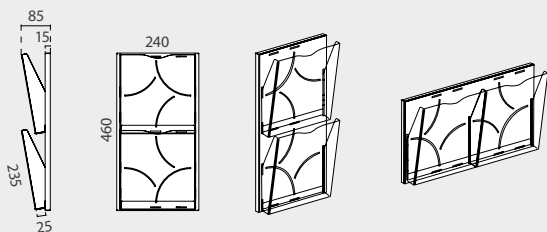

EXTERNAL SIZE

*mm



INFORMATION

This decorative panel for A4 brochures or documents has 2 methacrylate dispensers. Featuring the possibility of installing bolted to the wall vertically or horizontally. It is produced in BLACK RAL 9005 and GREY RAL 9006. It includes 1 black or grey metallic panel, 2 acrylic pockets, screws and hangers.

MULTIPLEX	QTY	N.W	G.W	C.B.M	SIZE	
Packing	1	1.49kg	1.92kg	0.0129	485x265x100mm	
13.374		Pocket Size: A5		x1		

MULTIPLEX WALL POCKET PANEL

black or grey color available



horizontal or vertical orientation available

HOLDER DETAILS



DIMENSIONS

* mm

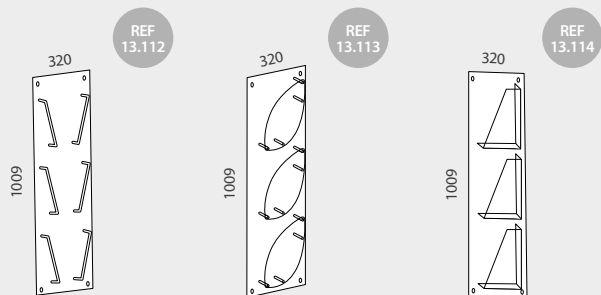

INFORMATION

These Wall Mount Holders are made of plastic, featuring 3 pockets with portrait orientation for A4 size documents. There are available 3 different models according to the shape of their pockets ("line" shaped, "oval" shaped or "straight" shaped pockets). These displays are ideal for displaying literature A4 documents placed at waiting rooms.

A4 LINE

SIZE

13.112

320x1009mm

x1 

A4 OVAL

SIZE

13.113

320x1009mm

x1 

A4 FLASH

SIZE

13.114

320x1009mm

x1 

WALL MOUNTED POLYSTYRENE HOLDER



HOLDER DETAILS



INFORMATION

* mm

This wall leaflet dispenser features a transparent pocket with portrait orientation for A4 size documents. Our display is ideal for displaying literature documents such as flyers, promotions, magazines placed at waiting rooms or offices.

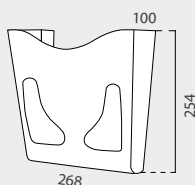

PORTRAIT W.P.	QTY	N.W	G.W	C.B.M	SIZE
Packing	1	0.32kg	0.52kg	0.008	270x270x115 mm
13.126	Size: A4 Portrait				x1 

WALL POCKET LEAFLET DISPENSER

HOLDER DETAILS



INFORMATION

* mm

This wall leaflet dispenser features a transparent pocket with landscape orientation for A4 size documents. Our display is ideal for displaying literature documents such as flyers, promotions, magazines placed at waiting rooms or offices.

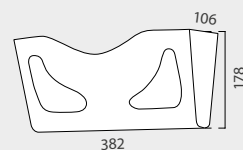

LANDSCAPE W.P.	QTY	N.W	G.W	C.B.M	SIZE
Packing	1	0.3kg	0.5kg	0.009	405x200x115 mm
13.127	Size: A4 Landscape				x1 

MAILBOX DETAILS



INFORMATION

* mm

This mailbox features a translucent body with portrait orientation and a black cover at the top. Our display is ideal for saving literature documents like flyers, promotions or suggestion forms placed at waiting rooms or offices.

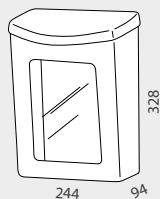

D. MAILBOX	QTY	N.W	G.W	C.B.M	SIZE
Packing	1	0.6kg	0.8kg	0.013	270x350x140 mm
13.125	Size: 244x328x94mm				x1 

DOCUMENT MAILBOX



BALLOT BOX

214x214x213mm

BALLOT BOX DETAILS



INFORMATION

*mm

This transparent ballot box is made of acrylic (Sides: 5mm thickness, Base, front and cap cover: 3mm thick and Top header: 1.5mm). It features a top landscape header which allows you to display graphic information and an easy change of graphics without having to open the unit. The old image is slid out the side through the openings. Clear entry boxes, acrylic ballot boxes are inexpensive marketing tools with a dual purpose. You can promote your business while creating an interactive display.

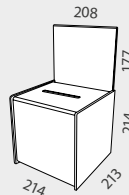

B. B.	214x214x213	QTY	N.W	G.W	C. B. M	SIZE
Packing	2	2.266kg	3.116kg	0.041	501x283x289 mm	
13.567	Graphic Size: 208x175mm		x2			

BALLOT BOX

LOCKABLE 224x210x210mm

BALLOT BOX DETAILS



INFORMATION

*mm

This transparent ballot box is made of 3mm thickness acrylic. It features a top A5 landscape header which allows you to display graphic information and an easy change of graphics without having to unlock the unit. The old image is slid out the side through the openings. Also, this acrylic ballot box has a key lock to keep the contents secure and control access. Each unit is shipped with two keys.

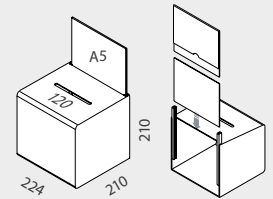

B. B.	224x210x210	GRAPHIC SIZE	THICKNESS
13.375	A5	3mm	x1

BALLOT BOX DETAILS





INFORMATION

* mm

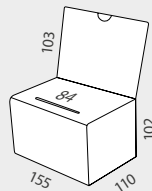
This transparent ballot box is made of acrylic. It features a 150x100mm top landscape header which allows you to display graphic information and an easy change of graphics without having to unlock the unit. The old image is slid out the side through the openings. Also, key lock is available to keep the contents secure and control access.



B. B.	150x110x102	QTY	N.W	G.W	C. B. M	SIZE
Packing	1	0.36kg	0.56kg	0.005	175x130x220 mm	
13.099	Graphic Size:150x100mm		x2			

B. B.	150x110x102 L	QTY	N.W	G.W	C. B. M	SIZE
Packing	1	0.32kg	0.52kg	0.005	175x130x220 mm	
13.100	Graphic Size:150x100mm		x2			

BALLOT BOX

155x110x102mm



BALLOT BOX DETAILS



INFORMATION

DIMENSIONS

*mm

This ballot boxes are made of 4mm thickness acrylic. Reference 13.833 features a frosted finish. References 13.568 and 13.569 transparent finish. Key lock is available to keep the contents secure and control access.

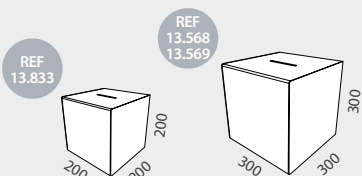

Frosted Ballot Box	QTY	N.W	G.W	C.B.M	SIZE
Packing	1	0.96kg	1.34kg	0.0165	255x250x260 mm
13.833		Size:200x200x200mm			x1 
Ballot Box 300	QTY	N.W	G.W	C.B.M	SIZE
Packing	1	1.88kg	2.738kg	0.0473	360x360x365 mm
13.568		Size:300x300x300mm			x1 
Lock Ballot Box 300	QTY	N.W	G.W	C.B.M	SIZE
Packing	1	1.9kg	2.762kg	0.0473	360x360x365 mm
13.569		Size:300x300x300mm			x1 

SQUARE SIMPLE BALLOT BOX



* the "L" acrylic at this page is available but not included.

BALLOT BOX DETAILS





INFORMATION

*mm

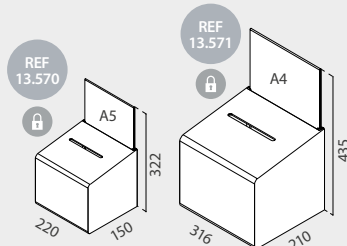
This Smoked ballot box is made of 3mm thickness acrylic. Features a top landscape header to display information. Easy change of graphics without having to unlock the unit through the side openings. Also, these acrylic ballot boxes have a key lock. Each unit is shipped with two keys.



A5 SMOKED	QTY	N.W	G.W	C.B.M	SIZE
Packing	2	1.89kg	2.42kg	0.0298	430x235x295 mm
13.570		Graphic Size: A5 Landscape			x2 
A4 SMOKED	QTY	N.W	G.W	C.B.M	SIZE
Packing	1	3.42kg	4.31kg	0.0587	510x295x390 mm
13.571		Graphic Size: A4 Landscape			x1 

SMOKED ACRYLIC LOCKABLE BALLOT BOX



BALLOT BOX DETAILS

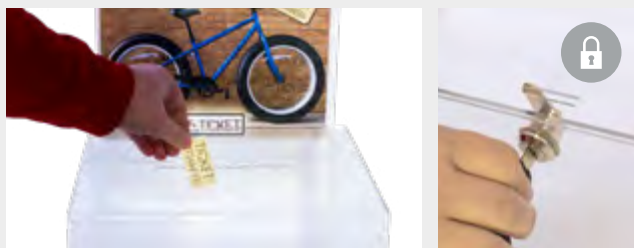

INFORMATION

* mm

This transparent ballot box is made of acrylic. It features a top A4 landscape header which allows you to display graphic information and an easy change of graphics without having to unlock the unit. The old image is slid out the side through the openings. Also, this acrylic ballot box has a key lock to keep the contents secure and control access. Each unit is shipped with two keys.

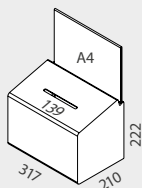

B.B.317x222x210	QTY	N.W	G.W	C.B.M	SIZE
Packing	1	1.7kg	1.9kg	0.022	290x240x330 mm
13.124	Graphic Size:297x210mm		x1 		

BALLOT BOX LOCKABLE 317x222x210mm

Ideal for tradeshows, retail stores, malls or supermarkets



BALLOT BOX DETAILS

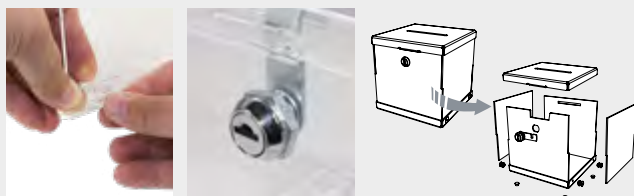

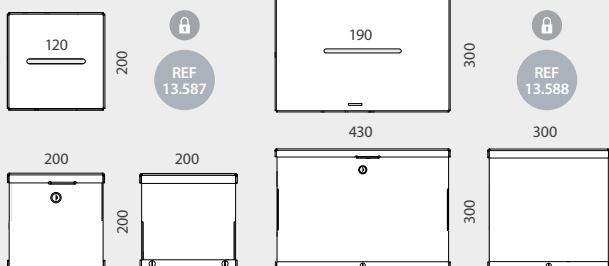

DIMENSIONS

* mm



INFORMATION

This transparent ballot box is made of 4mm thick acrylic. This removable ballot box has a key lock to keep the contents secure and control access. It includes 4 sides, 2 caps, 4 screws, Key lock + 2 Keys. Once removed, all parts are overlapped for an optimum storage. Each unit is shipped with two keys and all the pieces for a correct assembly. Ideal for tradeshows, retail stores, malls or supermarkets.

REMOVABLE 1	QTY	N.W	G.W	C.B.M	SIZE
Packing	1	0.95kg	1.05kg	0.003	265x220x55 mm
13.587	Size: 200x200x200mm		x1 		
REMOVABLE 2	QTY	N.W	G.W	C.B.M	SIZE
Packing	1	2.6kg	2.8kg	0.0083	495x325x55 mm
13.588	Size: 430x300x300mm		x1 		

REMOVABLE BALLOT BOX LOCKABLE 430x300x300mm

fully removable



ACRYLIC DETAILS

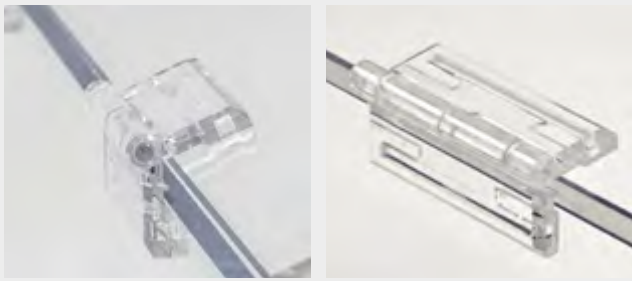

INFORMATION

Acrylic Hinges with 6 available sizes. Ideal for creating acrylic boxes or ballot boxes.



200mm ACRYLIC HINGE

Size

10.943	200mm	x20 
--------	-------	---



65mm ACRYLIC HINGE

Size

10.945	65mm	x20 
--------	------	---



30mm ACRYLIC HINGE

Size

10.947	30mm	x20 
--------	------	---

ACRYLIC HINGE

ACRYLIC DETAILS



100mm ACRYLIC HINGE

Size

10.944	100mm	x20 
--------	-------	---



45mm ACRYLIC HINGE

Size

10.946	45mm	x20 
--------	------	---



25mm ACRYLIC HINGE

Size

10.948	25mm	x20 
--------	------	---

3 PIECES ACRYLIC LOCK

ACRYLIC DETAILS

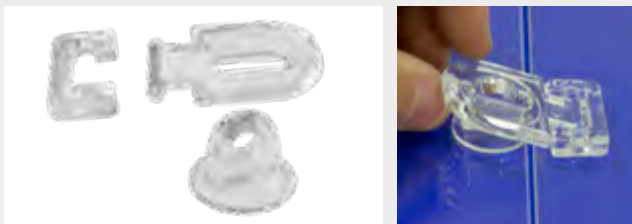

INFORMATION

Acrylic Lock composed by 3 pieces. Ideal for creating acrylic boxes or ballot boxes.

A.LOCK	Pieces	
10.949	3 pieces	x20 

ACRYLIC HANGER

ACRYLIC DETAILS



INFORMATION

Acrylic Hanger. Ideal for holding acrylic stands, boxes or ballot boxes.

A.HANGER	Size	
10.950	22x25mm	x20 



Textil 07

Complete range of displays, wall holding systems for the textile printing which provide an integral solution for the promotion at selling areas.

- 294** TEXTFIX
- 311** TEXTFIX ACCESSORIES
- 316** SEG SYSTEM
- 320** TENSION TEXTILE
- 342** TENSION TEXTILE ACCESSORIES
- 343** PROMOTION COUNTERS
- 346** INDOOR FLAG BANNERS
- 348** HANGING SIGNS
- 351** ROTATING STAND



NEW

TEXTIFIX DETAILS



DIMENSIONS

*mm

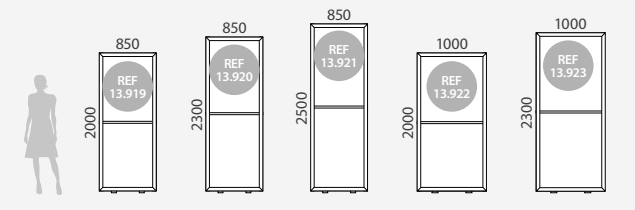

	QTY	N.W	G.W	C.B.M	SIZE
Packing	1	10.20kg	11.50kg	0.06216	140x370x1200mm
13.919WH	Graphic Size: 850x2000mm				
	QTY	N.W	G.W	C.B.M	SIZE
Packing	1	10.90kg	12.20kg	0.06216	140x370x1200mm
13.920WH	Graphic Size: 850x2300mm				
	QTY	N.W	G.W	C.B.M	SIZE
Packing	1	11.20kg	12.50kg	0.06216	140x370x1200mm
13.921WH	Graphic Size: 850x2500mm				
	QTY	N.W	G.W	C.B.M	SIZE
Packing	1	10.70kg	12.00kg	0.06216	140x370x1200mm
13.922WH	Graphic Size: 1000x2000mm				
	QTY	N.W	G.W	C.B.M	SIZE
Packing	1	11.40kg	12.70kg	0.06216	140x370x1200mm
13.923WH	Graphic Size: 1000x2300mm				

TEXTIFIX LIGHTBOX 



INFORMATION

UTILITIES

Texfix Lightbox is a complete kit system composed by a textile graphics inserted by a silicone strip in aluminum profiles. Easy and fast to assemble without tools. Ideal for fashion stores, shopwindows, theaters, cinemas, restaurants, events, tradeshows, offices, etc.



TEXTIFIX LIGHTBOX CONTENT

The Texfix Light Box contain everything necessary for its assembly: straight **A** and corner connectors **B**, aluminium and steel reinforcements **C**, aluminium feet **D** and a Complete LED System with LED Strips **E** and Power Supply **F**.

* The printing is not included in the price, but it is available separately. Please, request us.

NEW

TEXTIFIX DETAILS



TEXTIFIX LIGHTBOX

LED



DIMENSIONS

*mm

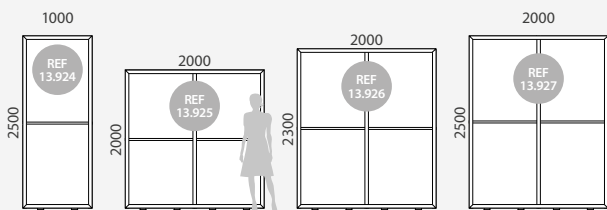

	QTY	N.W	G.W	C.B.M	SIZE
Packing	1	11.70kg	13.00kg	0.06216	140x370x1200mm
13.924WH	Graphic Size: 1000x2500mm				

	QTY	N.W	G.W	C.B.M	SIZE
Packing	1	14.70kg	16.50kg	0.0756	140x450x1200mm
13.925WH	Graphic Size: 2000x2000mm				

	QTY	N.W	G.W	C.B.M	SIZE
Packing	1	15.40kg	17.20kg	0.0756	140x450x1200mm
13.926WH	Graphic Size: 2000x2300mm				

	QTY	N.W	G.W	C.B.M	SIZE
Packing	1	15.70kg	17.50kg	0.0756	140x450x1200mm
13.927WH	Graphic Size: 2000x2500mm				











* The printing is not included in the price, but it is available separately. Please, request us.

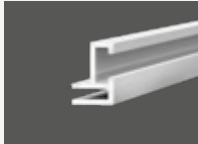

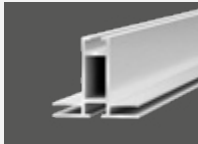
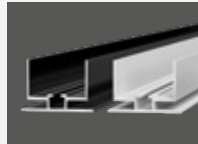
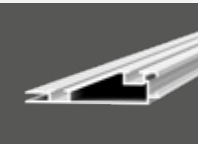
INFORMATION

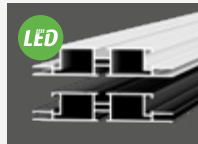
TexFix® is the abbreviation of Textil Fixing, our range of textile graphics exhibition applied on aluminum profiles. A system where innovation and high quality go hand in hand. The process of creating TexFix® is as simple as it is easy to apply: around the entire edge of the textile graphic a fine silicone cord is sewn and then inserted into the rail of the aluminum profile. Its versatility, simplicity of application and high visual impact (with the possibility of incorporating an LED system), makes it currently one of the most demanded and effective communication solutions in the market: store decoration, shop windows, offices, exhibitions, waiting rooms, as in the creation of stands, furniture, promotional totems or exhibitors.

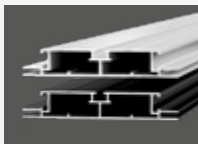
TEXTIFIX PROFILES

 LED LED ULTRA SLIM 15.5mm	 TEXFIX 16mm	 RECESSED TEXTIFIX 27.5mm
 TEXFIX 41.5x16mm	 TEXFIX 41.3x38mm	 ALUPROFIT 49mm
 TEXFIX 81.5mm	 TEXFIX 100mm	 LED COMPLETE KIT LED 100mm
 FAST TEXTIFIX 120mm	 FLAT TEXTIFIX 120mm	 TEXFIX 150mm

TEXTIFIX



* The printing is not included in the price, but it is available separately. Please, request us.

PROFILE DETAILS

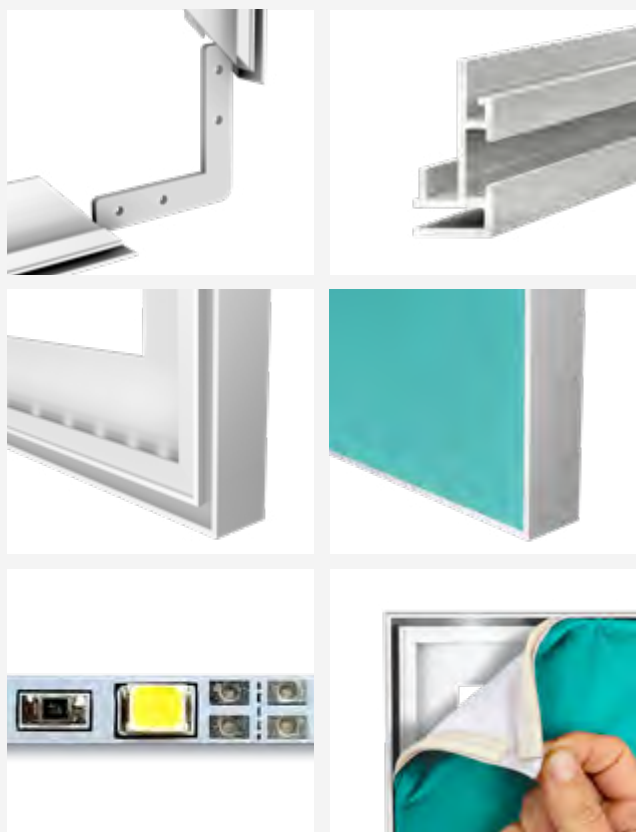

PROFILE DIMENSIONS *mm TEXTIL FIXING UTILITIES

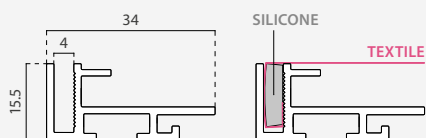

INFORMATION

The TexFix® LED Ultra Slim is designed to focus all attention on the backlighting of textile graphics. Its 15.5mm wide anodized aluminum profile is the lightest and slimmest of the whole range. Its LED system achieves an intense and homogeneous backlighting with a low energy consumption. Ideal for interior decoration of shops, offices, waiting rooms, exhibitions, shop windows or simply to create backlit representations of high visual impact on the wall. This assembled complete kit includes: hangers, corner connectors, methacrylate, Allen keys and a complete LED system. More sizes are available upon request.

REF	COLOR	GRAPHIC SIZE	N° OF SIDES
13.180	<input type="checkbox"/>	A4 (210x297mm)	1-Sided
13.179	<input type="checkbox"/>	A3 (297x420mm)	1-Sided
13.178	<input type="checkbox"/>	A2 (420x594mm)	1-Sided
13.177	<input type="checkbox"/>	A1 (594x841mm)	1-Sided
13.176	<input type="checkbox"/>	A0 (841x1189mm)	1-Sided
13.306	<input type="checkbox"/>	500x700mm	1-Sided
13.307	<input type="checkbox"/>	700x1000mm	1-Sided

* The printing is not included in the price, but it is available separately. Please, request us.

LED ULTRA SLIM
TEXTIFIX 15.5mm



PROFILE DETAILS



PROFILE DIMENSIONS *mm TEXTIL FIXING UTILITIES

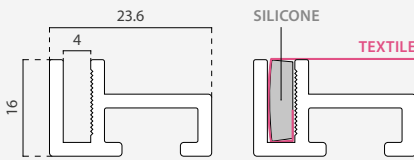

TEXTIFIX CONTENT (ONLY STANDARD KITS)





INFORMATION

With the 16mm TexFix® there is no limit to the format of the mural representation. Its 16mm wide anodized aluminum profile is the most solvent and requested option for graphic representations on the wall. Compatible with Hangers ref.13172 and 13708. This discreet and lightweight profile is ideal for decorating shops, offices, waiting rooms, exhibitions, shop windows or simply to decorate murals. The Standard Kits contain everything necessary for its assembly: 4 profiles, 2 hangers, 4 corner connectors and Allen keys.

STANDARD KITS

REF	COLOR	GRAPHIC SIZE	Nº SIDES	WALL MOUNTING
13.132		A4 (210x297mm)	1-Sided	Only Hangers
13.133		A3 (297x420mm)	1-Sided	Only Hangers
13.134		A2 (420x594mm)	1-Sided	Only Hangers
13.135		A1 (594x841mm)	1-Sided	Fixing with 
13.136		500x700mm	1-Sided	Fixing with 
13.137		700x1000mm	1-Sided	Fixing with 
13.138		500x1000mm	1-Sided	Fixing with 

LINEAR METERS

REF	COLOR	LENGTH	PACK
13.139		3m	4u x  (total: 12m/l)

TEXTIFIX 16mm





CORNER CONNECTOR
36mm

REF	DIMENSIONS	PACK
13.171	36x36mm	20u x 



WALL MOUNTING HANGER

REF	DIMENSIONS	PACK
13.172	28x53mm	20u x 

* The printing is not included in the price, but it is available separately. Please, request us.

PROFILE DETAILS



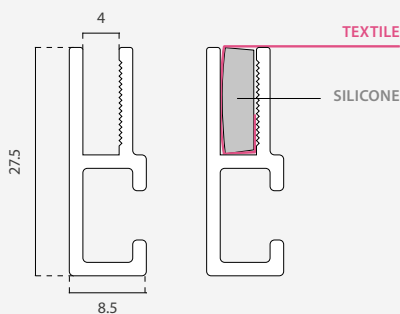

PROFILE DIMENSIONS *mm TEXTIL FIXING UTILITIES



INFORMATION

The 27.5mm TexFix® Recessed Wall is specially designed to take advantage of gaps and free spaces in the walls. A perfect option for obtaining a mural representation with textile graphics completely integrated to the point of sale. Its 27.5mm anodized aluminum profile offers a simple, fast and compact wall installation. This discreet profile is an ideal option for decorating offices, waiting rooms, exhibitions, shop windows or simply to create graphic murals at the point of sale and get a great visual impact. The corner connectors (ref. 13.243) are available for an easy assembly.

LINEAR METERS

REF	COLOR	LENGTH	PACK
13.157		3m	4u x  (total: 12m/l)



REF	DIMENSIONS	PACK
13.243	40x40mm	20u x 

* The printing is not included in the price, but it is available separately. Please, request us.

RECESSED WALL
TEXTIFIX 27.5mm



PROFILE DETAILS



PROFILE DIMENSIONS *mm TEXTIL FIXING UTILITIES

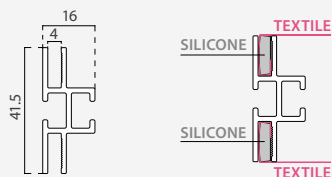

TEXTIFIX CONTENT (ONLY STANDARD KITS)







INFORMATION

The 41.5x16mm **TexFix®** Double Side is one of the most versatile and solvent profiles of the whole range. Its anodized aluminum profile is lighter than its successors, so it is ideal for graphic representations suspended from the ceiling. Compatible with connectors **ref.13243**, hangers **ref.10197** and other **TexFix®** accessories. The Standard Kit contains: 4 profiles, 4 corner connectors and Allen keys. Ideal for signaging in stores, waiting rooms, exhibitions, shop windows or as a space divider. Other sizes are available upon request.



IMPORTANT | TEXTIFIX LARGER THAN 2 METERS

When the **TexFix®** exceeds 2m on one of its sides, it is necessary to use the Central Reinforcement Profile to ensure its stability. See later in accessories all the appropriate and necessary information according to your **TexFix®**.

STANDARD KITS

REF	COLOR	GRAPHIC SIZE	Nº OF SIDES
13.158		A4 (210x297mm)	2-Sided
13.159		A3 (297x420mm)	2-Sided
13.160		A2 (420x594mm)	2-Sided
13.161		A1 (594x841mm)	2-Sided

LINEAR METERS

	QTY	N.W	G.W	C.B.M	SIZE
Packing	4	4.66kg	5.11kg	0.0147	75x65x3015mm
13.170		Length: 3m		4u x  (total: 12m/l)	

*2 the hanger at this page are available but not included. See more accessories later at this chapter.

TEXTIFIX 41.5x16mm
DOUBLE-SIDED



CORNER
CONNECTOR
40mm

REF	DIMENSIONS	PACK
13.243	40x40mm	20u x 



HANGER
FOR CEILING

REF	DIMENSIONS	PACK
10.197	46x25mm	10u x 

* The printing is not included in the price, but it is available separately. Please, request us.

PROFILE DETAILS



PROFILE DIMENSIONS *mm TEXTIL FIXING UTILITIES

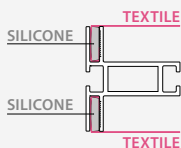
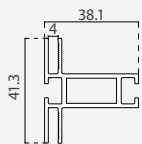

TEXTIFIX CONTENT (ONLY STANDARD KITS)



INFORMATION

This TexFix® is one of the most versatile and requested profiles. Its 41.3mm wide and 38mm deep profile (more robust than its predecessors) is a highly used solution for graphic representation on totems. Compatible with connectors ref.13243 and other accessories. The Standard Kit contains: 4 profiles, 4 corner connectors and Allen keys. Ideal option for decoration in stores, waiting rooms, exhibitions, shop windows or as a space divider with great visual impact.

IMPORTANT | TEXTIFIX LARGER THAN 2 METERS

When the TexFix® exceeds 2m on one of its sides, it is necessary to use the Central Reinforcement Profile to ensure its stability. See later in accessories all the appropriate and necessary information according to your TexFix®.

STANDARD KITS

REF	COLOR	GRAPHIC SIZE	Nº OF SIDES
13.163		500x700mm	2-Sided
13.166		500x1000mm	2-Sided
13.164		700x1000mm	2-Sided
13.162		A0 (841x1189mm)	2-Sided
13.167		1000x1000mm	2-Sided
13.165		1000x1400mm	2-Sided
13.168		1000x1500mm	2-Sided
13.282		700x2000mm	2-Sided
13.169		1000x2000mm	2-Sided

LINEAR METERS

REF	COLOR	LENGTH	PACK
13.058		3m	4u x (total: 12m/l)

** the bases at this page are available but not included. See more accessories later at this chapter.

TEXTIFIX 41.3x38mm
DOUBLE-SIDED



CORNER
CONNECTOR
40mm

REF	DIMENSIONS	PACK
13.243	40x40mm	20u x



STRAIGHT
BASE

REF	DIMENSIONS	PACK
13.175	160x450mm	2u x

* The printing is not included in the price, but it is available separately. Please, request us.

PROFILE DETAILS

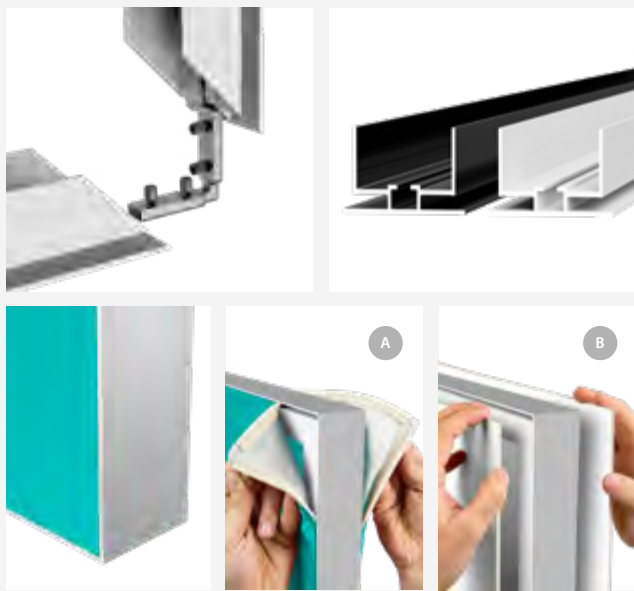

DIMENSIONS *mm TEXTIL | RIGID MATERIAL FIXING UTILITIES

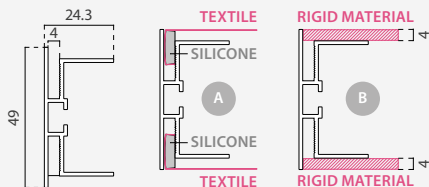

* The ends of profile are mitred / Couper en biais à 45° / Corte em esquadria de 45° / Perfil cortado a inglete. 

TEXTIL AND RIGID MATERIAL INFORMATION

The main feature of the TexFix® Aluprofit is its ability to adapt to the point of sale. The 49mm wide anodized aluminum profile of Aluprofit TexFix® is specially designed for being used with **textile** **A** or **rigid panels up to 4mm** **B**. In addition, this profile is available in two finishes: anodized and black lacquered. This profile is ideal for the creation of space dividers or totems of great visual impact, also for signaging in waiting rooms or simply to decorate shops, exhibitions or showcases. Compatible with TexFix® connectors ref.13243. The Standard Kit contains 2 profiles of 2, 3 or 4m length (more sizes available upon request).

IMPORTANT | TEXTIFIX LARGER THAN 2 METERS

When the TexFix® exceeds 2m on one of its sides, it is necessary to use the **Central Reinforcement Profile** to ensure its stability. See later in accessories all the appropriate and necessary information according to your TexFix®.

LINEAR METERS

REF	COLOR	LENGTH	PACK
13.644	 	2m	2u x  (total: 4m/l)
13.645	 	3m	2u x  (total: 6m/l)
13.646	 	4m	2u x  (total: 8m/l)

* the bases on this page need to drill the profile for their assembly and also, they are available but not included. See these bases and a complete range of accessories later at this chapter.

ALUPROFIT 49mm
DOUBLE-SIDED



CORNER
CONNECTOR
40mm

REF	DIMENSIONS	PACK
13.243	40x40mm	20u x 

PROFILE DETAILS



DIMENSIONS *mm

TEXTIL FIXING

UTILITIES

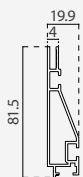

* The ends of profile are mitred / Couper en biais à 45° / Corte em esquadria de 45° / Perfil cortado a inglete. 

INFORMATION

The 81.5x19.9mm TexFix® is designed for large format murals and covering large surfaces. Compatible with hangers ref.13172 and LED system (available, but no included). This profile is ideal for covering corridors, walls or simply for decoration of large surfaces in stores, exhibitions or shop windows. Supplied in packs with 2 profiles of 2, 3 or 4m length (more sizes available upon request).

IMPORTANT | TEXTIFIX LARGER THAN 2 METERS

When the TexFix® exceeds 2m on one of its sides, it is necessary to use the Central Reinforcement Profile to ensure its stability. See later in accessories all the appropriate and necessary information according to your TexFix®.

LINEAR METERS

REF	COLOR	LENGTH	PACK
13.647		2m	2u x  (total: 4m/l)
13.648		3m	2u x  (total: 6m/l)
13.649		4m	2u x  (total: 8m/l)



CORNER CONNECTOR

63mm

REF	DIMENSIONS	PACK
13.333	63x63mm	20u x 



CORNER CONNECTOR

40mm

REF	DIMENSIONS	PACK
13.243	40x40mm	20u x 

TEXTIFIX 81.5mm





WALL MOUNTING HANGER

REF	DIMENSIONS	PACK
13.172	28x53mm	20u x 

* The printing is not included in the price, but it is available separately. Please, request us.

PROFILE DETAILS

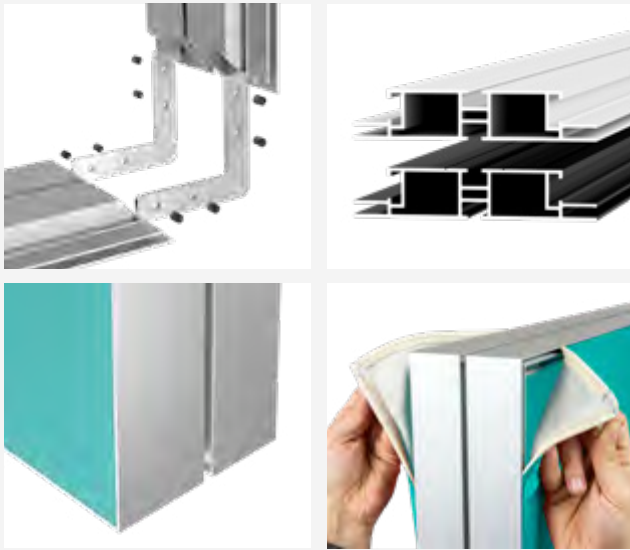

PROFILE DIMENSIONS *mm TEXTIL FIXING UTILITIES

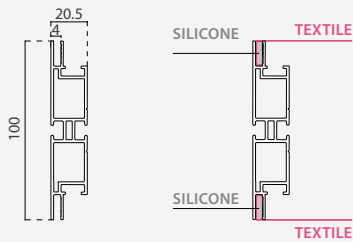

* The ends of profile are mitred / Couper en biais à 45° / Corte em esquadria de 45° / Perfil cortado a inglete. 

INFORMATION

The 100x20.5mm **TexFix®** is the most requested profile on the market. Designed with a central channel for adapting to a wide range of accessories like center reinforcements, connectors, hangers and for using LED system (all these accessories are optionally available later). Among its multiple applications are: creation of stands, space dividers, totems, signage, shop lining, offices, corridors, shop window and interior decoration, exhibitors and commercial furniture. Each pack contains 2 profiles from 0.5m to 3m length (more sizes available upon request).

IMPORTANT | TEXTIFIX LARGER THAN 2 METERS

When the **TexFix®** exceeds 2m on one of its sides, it is necessary to use the **Central Reinforcement Profile** to ensure its stability. See later in accessories all the appropriate and necessary information according to your **TexFix®**.

LINEAR METERS

REF	COLOR	LENGTH	PACK
13.300		0.5m	2u x (total: 1m/l)
13.301		1m	2u x (total: 2m/l)
13.302		1.5m	2u x (total: 3m/l)
13.303		2m	2u x (total: 4m/l)
13.304		2.5m	2u x (total: 5m/l)
13.305		3m	2u x (total: 6m/l)

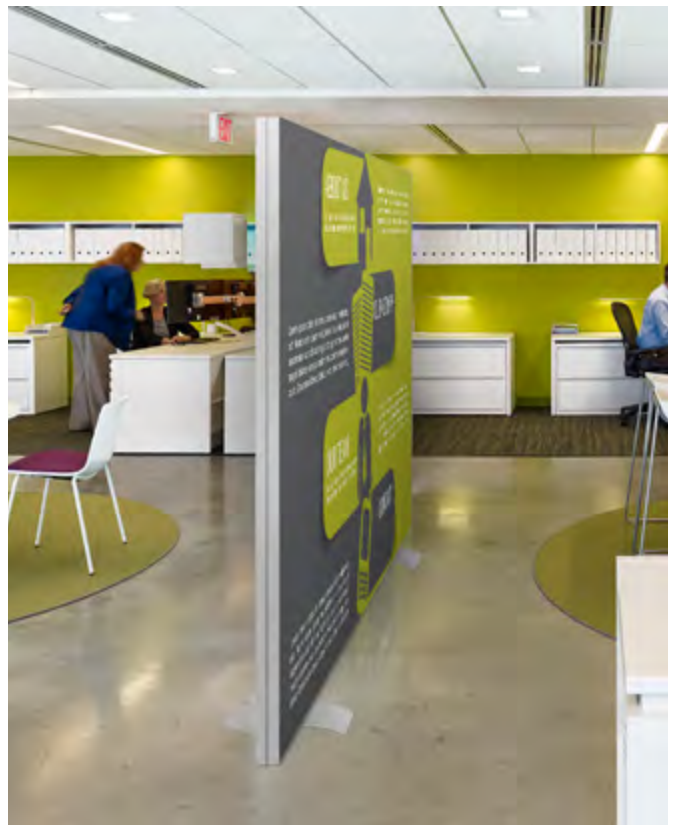

* the bases at this page are available but not included with the profile. See accessories later at this chapter.

TEXTIFIX 100mm
DOUBLE-SIDED





















* The printing is not included in the price, but it is available separately. Please, request us.



TRAY

DOCUMENT
HOLDER

REF	SIDE	FORMAT	PACK
13.444	Left	A4	  2u x 
13.445	Right	A4	  2u x 
13.440	Left	1/3 A4	  2u x 
13.441	Right	1/3 A4	  2u x 
13.442	Left	A5	  2u x 
13.443	Right	A5	  2u x 





CORNER CONNECTOR

63mm

REF	DIMENSIONS	PACK
13.333	63x63mm	20u x 

STRAIGHT BASE

REF	DIMENSIONS	PACK
13.175	 160x450mm	2u x 



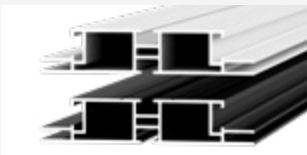
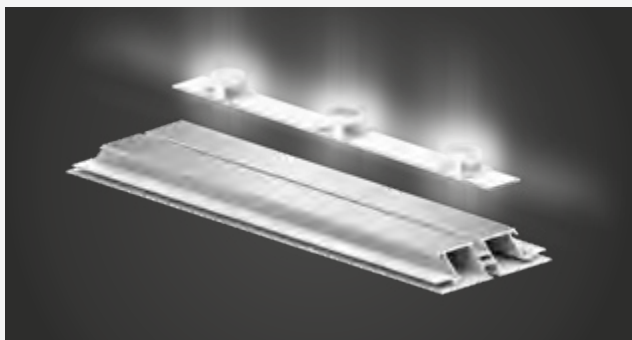

* the bases and trays at this page are not included with the profile. See more accessories later at this chapter. * The printing is not included in the price, but it is available separately. Please, request us.

PROFILE DETAILS

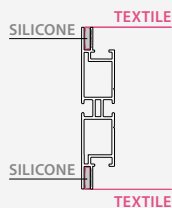
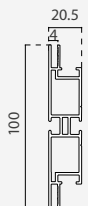

DIMENSIONS *mm TEXTIL FIXING UTILITIES



* The ends of profile are mitred / Couper en biais à 45° / Corte em esquadria de 45° / Perfil cortado a inglete. 

INFORMATION

The Complete LED Kits 100mm contain everything necessary for its assembly: 4 profiles **A**, 8 corner connectors **B**, Reinforcements **C** and locks **D** (only when one of the profiles exceeds 2m), Allen keys and a Complete LED System with LED Strips **E** and Power Supply **F**. Its backlighting capacity and multiple TextiFix® accessories allow its application in very different commercial sectors like: fashion stores, theaters, parkings, cinemas, restaurants, galleries, promotional events, shopping centers, tradeshows, museums, offices, etc.

COMPLETE LED KIT
TEXTIFIX 100mm DOUBLE-SIDED

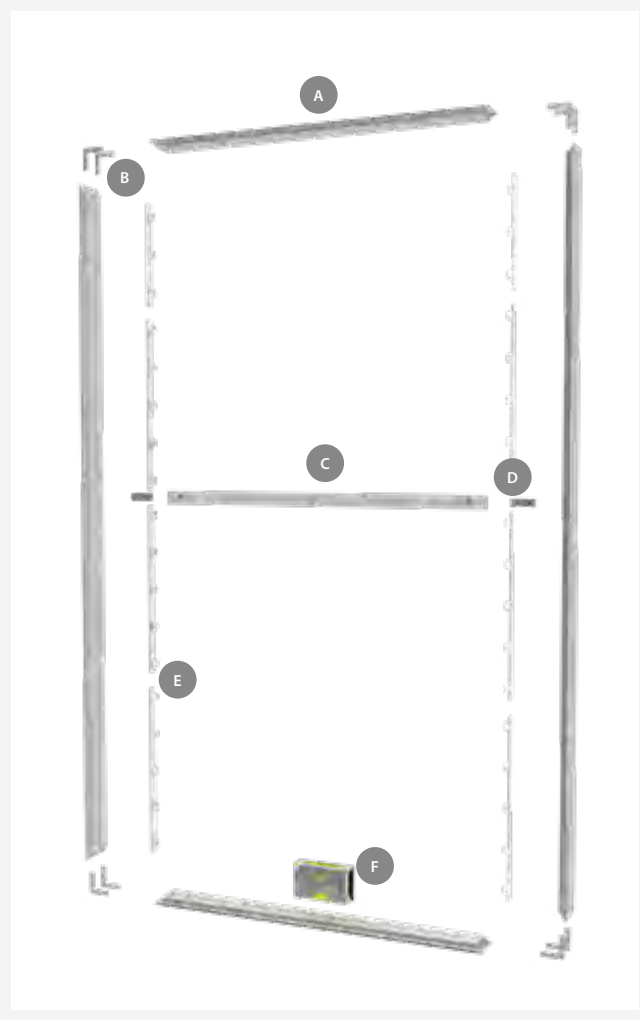

* The printing is not included in the price, but it is available separately. Please, request us.

KIT CONTAINS
EVERYTHING NECESSARY



FOLLOW
THE INSTRUCTIONS

TEXTILE
PRINTING NEEDED?

REQUEST-US
CASHDISPLAY.COM

600mm		700mm		1000mm		1500mm		2000mm		2500mm		3000mm	
	600x600m		700x600m		1000x600m		1500x600m		2000x600m		2500x600m		3000x600m
LED 500 x1 Uni.		LED 500 x1 Uni. Use in 600mm sides		LED 500 x1 Uni. Use in 600mm sides		LED 500 x2 Uni. Use in 600mm sides		LED 300 x1 Uni. + LED 500 x3 Uni. (In 2000mm sides)		LED 500 x3 Uni. LED 300 x2 Uni. (In 2500mm sides)		LED 500 x4 Uni. LED 300 x2 Uni. (In 3000mm sides)	
60W 24Vx1 Uni		60W 24Vx1 Uni		60W 24Vx1 Uni		60W 24Vx1 Uni		100W 24Vx1 Uni	1 Central Reinforcement	100W 24Vx1 Uni	1 Central Reinforcement	100W 24Vx1 Uni	2 Central Reinforcements
13.308	136.40 €/Kit	13.309	136.40 €/Kit	13.310	141.30 €/Kit	13.311	184.45 €/Kit	13.312	238.50 €/Kit	13.313	290.00 €/Kit	13.314	336.40 €/Kit
	700x700m		1000x700m		1500x700m		2000x700m		2500x700m		3000x700m		
LED 500 x1 Uni.		LED 500 x1 Uni. Use in 700mm side		LED 500 x2 Uni. Use in 700mm sides		LED 300 x1 Uni. + LED 500 x3 Uni. (In 2000mm sides)		LED 500 x3 Uni. LED 300 x2 Uni. (In 2500mm sides)		LED 500 x4 Uni. LED 300 x2 Uni. (In 3000mm sides)			
60W 24Vx1 Uni		60W 24Vx1 Uni		60W 24Vx1 Uni		100W 24Vx1 Uni	1 Central Reinforcement	100W 24Vx1 Uni	1 Central Reinforcement	100W 24Vx1 Uni	2 Central Reinforcements		
13.315	141.30 €/Kit	13.316	148.80 €/Kit	13.317	191.95 €/Kit	13.318	250.00 €/Kit	13.319	293.25 €/Kit	13.320	338.95 €/Kit		
	1000x1000m		1500x1000m		2000x1000m		2500x1000m		3000x1000m				
LED 500 x1 Uni. LED 300 x1 Uni.		LED 500 x2 Uni. LED 300 x1 Uni.		LED 500 x6 Uni. + LED 300 x2 Uni. (In 2000mm sides)		LED 500 x6 Uni. LED 300 x4 Uni. (In 2500mm sides)		LED 500 x8 Uni. LED 300 x4 Uni. (In 3000mm sides)					
60W 24Vx1 Uni. (in 1000mm sides)		60W 24Vx1 Uni. (in 1500mm sides)		150W 24Vx1 Uni	1 Central Reinforcement	150W 24Vx1 Uni	1 Central Reinforcement	200W 24Vx1 Uni	2 Central Reinforcements				
13.321	166.20 €/Kit	13.322	209.35 €/Kit	13.323	324.50 €/Kit	13.324	365.75 €/Kit	13.325	421.30 €/Kit				
	1500x1500m		2000x1500m		2500x1500m		3000x1500m						
LED 500 x4 Uni. LED 300 x2 Uni. (In 1500mm sides)		LED 500 x6 Uni. LED 300 x2 Uni. (In 2000mm sides)		LED 500 x6 Uni. LED 300 x4 Uni. (In 2500mm sides)		LED 500 x8 Uni. LED 300 x4 Uni. (In 3000mm sides)							
100W 24Vx1 Uni. (in 1500mm sides)		150W 24Vx1 Uni	1 Central Reinforcement	150W 24Vx1 Uni	2 Central Reinforcements	200W 24Vx1 Uni	2 Central Reinforcements						
13.326	305.00 €/Kit	13.327	368.15 €/Kit	13.328	448.80 €/Kit	13.329	516.95 €/Kit						
	2000x2000m		2500x2000m		3000x2000m								
LED 500 x6 Uni. LED 300 x2 Uni. (In 2000mm sides)		LED 500 x6 Uni. LED 300 x4 Uni. (In 2500mm sides)		LED 500 x8 Uni. LED 300 x4 Uni. (In 3000mm sides)									
200W 24Vx1 Uni	2 Central Reinforcements	200W 24Vx1 Uni	2 Central Reinforcements	200W 24Vx1 Uni	2 Central Reinforcements								
13.330	424.30 €/Kit	13.331	491.65 €/Kit	13.332	566.50 €/Kit								

600mm

700mm

1000mm

1500mm

2000mm

PROFILE DETAILS

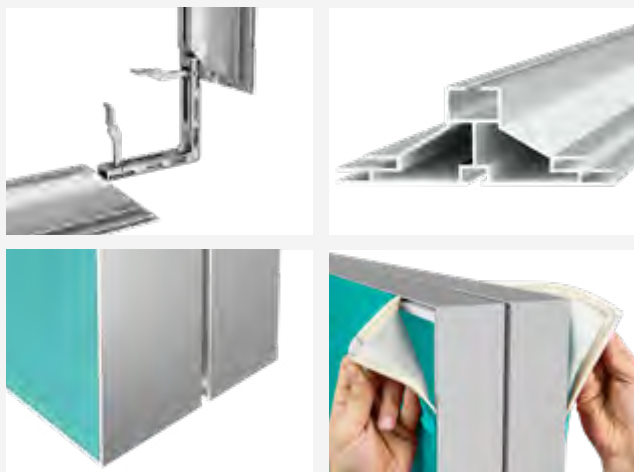

DIMENSIONS *mm

TEXTIL FIXING

UTILITIES

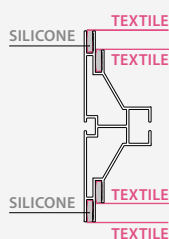
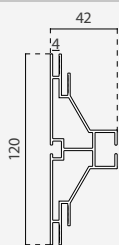

* The ends of profile are mitred / Couper en biais à 45° / Corte en esquadria de 45° / Perfil cortado a inglete. 









INFORMATION

The main feature of the Fast TexFix® 120mm is its fast and easy installation thanks to its Fast TexFix® ref.13493 connectors that allow it to be assembled and disassembled in a few minutes and without tools. Its design incorporates 2 guides for a textile graphic representation at two levels per side (ideal to create light reserves in the graphics or to improve the diffusion of light in them). In addition, it is compatible with TexFix® accessories, which is ideal for shop windows, creating stands, furniture or for decorating large surfaces.

IMPORTANT | TEXTIFIX LARGER THAN 2 METERS

When the TexFix® exceeds 2m on one of its sides, it is necessary to use the Central Reinforcement Profile to ensure its stability. See later in accessories all the appropriate and necessary information according to your TexFix®.

LINEAR METERS

REF	COLOR	LENGTH	PACK
13.492		0.5m	2u x  (total: 1m/l)
13.491		1m	2u x  (total: 2m/l)
13.490		2m	2u x  (total: 4m/l)
13.489		3m	2u x  (total: 6m/l)



FAST
CORNER
CONNECTOR

REF	DIMENSIONS	PACK
13.493	111x111x20.7mm	4u x 

* the bases at this page are available but not included with the profile. See accessories later at this chapter.

FAST TEXTIFIX 120mm
DOUBLE-SIDED



* The printing is not included in the price, but it is available separately. Please, request us.

PROFILE DETAILS

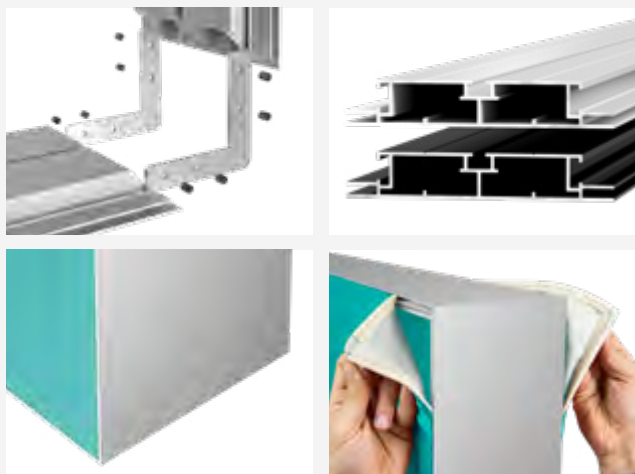

DIMENSIONS *mm

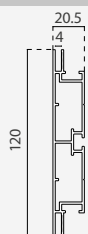

TEXTIL FIXING

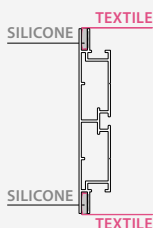

UTILITIES

* The ends of profile are mitred / Couper en biais à 45° / Corte en esquadra de 45° / Perfil cortado a inglete. 







INFORMATION

The Flat TexFix® is specially designed for large format structures. Its flat anodized aluminum profile, 120mm wide and only 20.5mm deep, is ideal for covering large surfaces and provides solidity while stylizing graphic representations. In addition, it incorporates a guide rail for the use of LED system (optionally available). Its wall installation is quick and easy thanks to the TexFix® hangers ref.13774. This profile is ideal for creating stands, for covering corridors, furniture or for decorating large surfaces in tradeshow, stores, exhibitions or shop windows.

IMPORTANT | TEXTIFIX LARGER THAN 2 METERS

When the TexFix® exceeds 2m on one of its sides, it is necessary to use the Central Reinforcement Profile to ensure its stability. See later in accessories all the appropriate and necessary information according to your TexFix®.

LINEAR METERS

REF	COLOR	LENGTH	PACK
13.650		2m	2u x  (total: 4m/l)
13.651		3m	2u x  (total: 6m/l)
13.652		4m	2u x  (total: 8m/l)

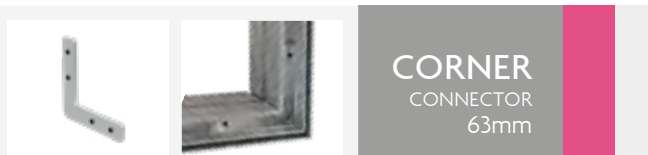

CORNER CONNECTOR 63mm

REF	DIMENSIONS	PACK
13.333	63x63mm	20u x 

FLAT TEXTIFIX 120mm DOUBLE-SIDED



* the bases and trays at this page are not included with the profile. See more accessories later at this chapter. * The printing is not included in the price, but it is available separately. Please, request us.

PROFILE DETAILS

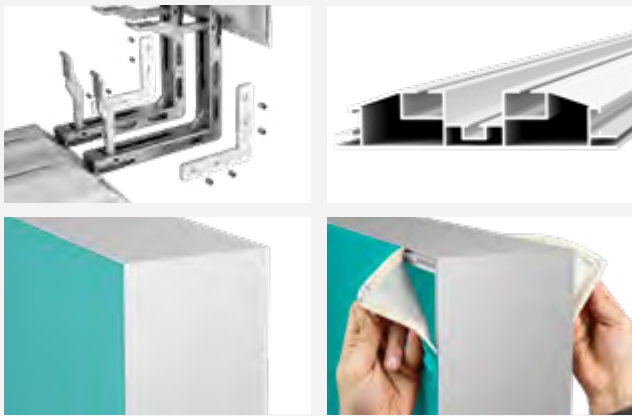

DIMENSIONS *mm

TEXTIL FIXING

UTILITIES

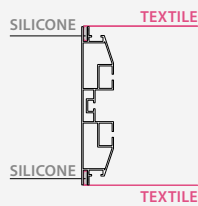
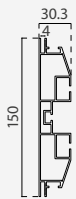

* The ends of profile are mitred / Couper en biais à 45° / Corte em esquadria de 45° / Perfil cortado a inglete. 

INFORMATION

This is the widest profile on the TexFix® market. Its flat design provides solidity while stylizing its graphic representations. In addition, it incorporates a guide rail for the use of LED system (optionally available). Its wall installation is quick and easy thanks to the TexFix® hangers ref.13774. This profile is ideal for creating stands, furniture, to line corridors or for the decoration of large surfaces in stores, exhibitions or shop windows.

IMPORTANT | TEXTFIX LARGER THAN 2 METERS

When the TexFix® exceeds 2m on one of its sides, it is necessary to use the Central Reinforcement Profile to ensure its stability. See it later in accessories.

LINEAR METERS

REF	COLOR	LENGTH	PACK
13.653		2m	2u x  (total: 4m/l)
13.654		3m	2u x  (total: 6m/l)
13.655		4m	2u x  (total: 8m/l)

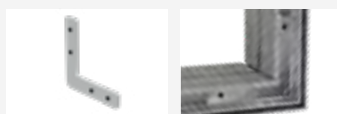

CORNER
CONNECTOR
63mm

REF	DIMENSIONS	PACK
13.333	63x63mm	20u x 



FAST
CORNER
CONNECTOR

REF	DIMENSIONS	PACK
13.493	111x111x20.7mm	4u x 

TEXTFIX 150mm
DOUBLE-SIDED



* The printing is not included in the price, but it is available separately. Please, request us.

CONNECTOR DETAILS INFORMATION DIMENSIONS *mm



This Corner Connector 36mm is only suitable for joining the 16mm TexFix® profiles, providing stable corner unions. It includes Allen screws for an easy and fast set up.

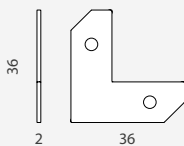

	QTY	N.W	G.W	C.B.M	SIZE
Packing	20	0.18kg	0.26kg	0.0008	120x110x65mm
13.171	36x36mm	20u x			

CORNER CONNECTOR 36mm



CONNECTOR DETAILS INFORMATION DIMENSIONS *mm



This Corner Connector provides stable corner unions and is suitable for joining the next TexFix® profiles: 27.5mm, 41.5mm, 41.3mm, 49mm and 81.5mm. It includes Allen screws for an easy set up.

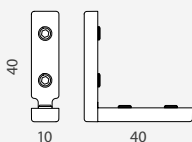

	QTY	N.W	G.W	C.B.M	SIZE
Packing	20	0.43kg	0.51kg	0.0008	120x110x65mm
13.243	40x40mm	20u x			

CORNER CONNECTOR 40mm



CONNECTOR DETAILS INFORMATION DIMENSIONS *mm



This Corner Connector provides stable corner unions and is suitable for joining the following TexFix® profiles: UltraSlim, 81.5mm, 100mm, Flat and 150mm. With Allen screws for an easy set up.

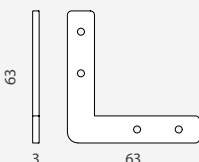

	QTY	N.W	G.W	C.B.M	SIZE
Packing	20	0.67kg	0.75kg	0.0008	120x110x65mm
13.333	63x63mm	20u x			

CORNER CONNECTOR 63mm



CONNECTOR DETAILS INFORMATION DIMENSIONS *mm



This Corner Connector provides stable corner unions and allows quick assembly without any tools. It is suitable for joining the following TexFix® profiles: Fast TexFix® and 150mm.

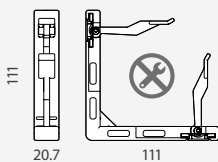

	QTY	N.W	G.W	C.B.M	SIZE
Packing	4	1.06kg	1.18kg	0.0010	145x120x60mm ^o
13.493	111x111mm	4u x			

FAST CORNER CONNECTOR



HANGER DETAILS INFORMATION DIMENSIONS *mm



This hanger is designed for the ceiling suspension of **TexFix®** frames. Fits on the next double-sided **TexFix®** profiles: 41.5mm, 41.3mm, 100mm and **Fast TexFix®**.



	QTY	N.W	G.W	C.B.M	SIZE
Packing	10	0.03kg	0.03kg	0.0004	150x100x25mm
13.334	24x21.5mm			10u x 	

CEILING HANGER 21.5mm



HANGER DETAILS INFORMATION DIMENSIONS *mm



This hanger is designed for the ceiling suspension of **TexFix®** frames. Fits on the next double-sided **TexFix®** profiles: 41.5mm, 41.3mm, 100mm and **Fast TexFix®**.

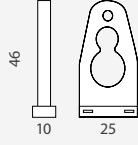

	QTY	N.W	G.W	C.B.M	SIZE
Packing	10	0.04kg	0.10kg	0.0004	65x10x65mm
10.197	25x46mm			10u x 	

CEILING HANGER 46mm



HANGER DETAILS INFORMATION DIMENSIONS *mm



This hanger is suitable for wall mounting of the following **TexFix®** profiles: **UltraSlim**, 16mm and also, 81.5mm. Includes Allen screw for an easy set-up.

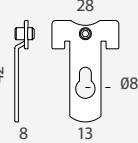

	QTY	N.W	G.W	C.B.M	SIZE
Packing	20	0.31kg	0.45kg	0.0004	85x45x15mm
13.172	28x42mm			20u x 	

WALL HANGER 42mm



HANGER DETAILS INFORMATION DIMENSIONS *mm



This hanger is suitable for wall mounting of the following **TexFix®** profiles: **UltraSlim**, 16mm and also, 81.5mm. It is manufactured with a 2mm steel plate.

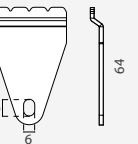

	QTY	N.W	G.W	C.B.M	SIZE
Packing	4	0.12kg	0.13kg	0.0001	70x50x30mm
13.708	40x64mm			4u x 	

WALL HANGER 64mm



HANGER DETAILS INFORMATION DIMENSIONS *mm



This hanger is suitable for wall mounting of the following **TexFix®** profiles: 100mm, **Flat TexFix®** and 150mm. It is manufactured with a 2mm steel plate.

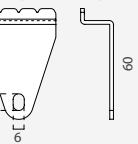

	QTY	N.W	G.W	C.B.M	SIZE
Packing	4	0.135kg	0.145kg	0.0003	170x100x15mm
13.774	40x60mm			4u x 	

WALL HANGER 60mm



REINFORCEMENT DETAILS **DIMENSIONS** *mm

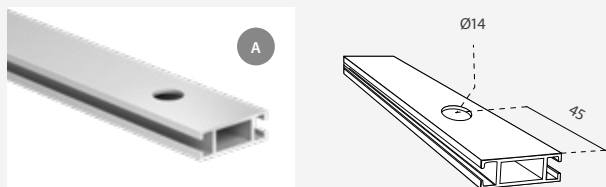

INFORMATION

When the TexFix® exceeds 2m on one of its sides, it is necessary to use the Central Reinforcement to ensure the stability of its structure. Made of aluminum and its assembly is very simple, you just have to make two holes of 14mm diameter at a distance of 45mm at its ends. In this way, the Locks are introduced at both ends and next to the reinforcement they are connected to the TexFix® profiles.

REINFORCEMENT SIZES

REF	LENGTH	PACK
13.342	559mm	2u x 
13.343	659mm	2u x 
13.344	959mm	2u x 
13.345	1459mm	2u x 
13.346	1959mm	2u x 
13.347	2459mm	2u x 
13.348	2959mm	2u x 

LINEAR METERS

	QTY	N.W	G.W	C.B.M	SIZE
Packing	4	5.05kg	5.40kg	0.0147	75x65x3020mm
13.246		3m	4u x 	(total: 12m/l)	

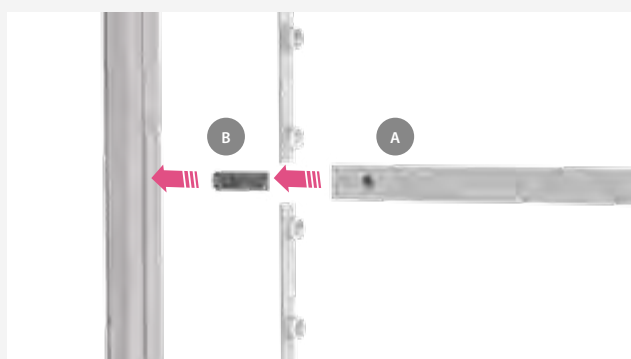

CENTRAL REINFORCEMENT

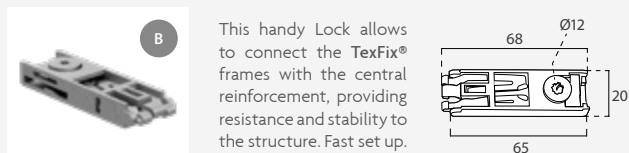

LOCK DETAILS **INFORMATION** **DIMENSIONS** *mm



This handy Lock allows to connect the TexFix® frames with the central reinforcement, providing resistance and stability to the structure. Fast set up.

	QTY	N.W	G.W	C.B.M	SIZE
Packing	2	0.071kg	0.071kg	0.0004	150x100x25mm
13.244		68x20mm	2u x 		

LOCK FOR CENTRAL REINFORCEMENT



STRIP DETAILS **INFORMATION**



This white silicone strip is ±12mm width and with 3.4mm thickness. The strip, once sewn to the fabric, allows to create a guide which is inserted into the rail of the profile being tight and perfectly framed.

	QTY	N.W	G.W	C.B.M	SIZE
Packing	1	0.45kg	0.52kg	0.0021	100x80x265mm
13.173		12x3.4mm	10m/l		

SILICONE STRIP



BASE DETAILS

INFORMATION *mm

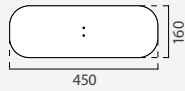

These metal bases are available on black or silver finish. **Protective round pads and screws** included.

	QTY	N.W	G.W	C.B.M	SIZE
Packing	2	5.9kg	6.1kg	0.0031	510x175x35mm
13.175	 	450x160mm		2u x 	

STRAIGHT BASE

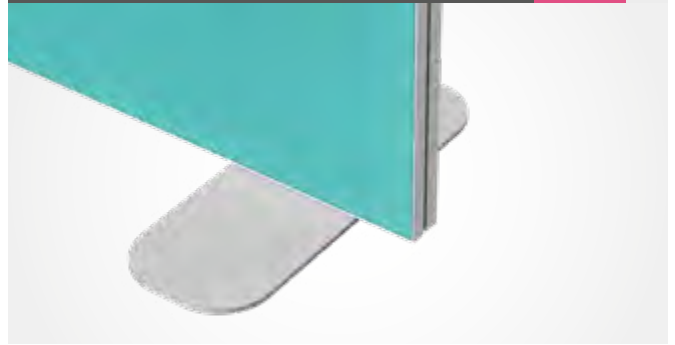



BASE DETAILS

INFORMATION *mm



These metal bases are available on black or silver finish. **Protective round pads and screws** included.

	QTY	N.W	G.W	C.B.M	SIZE
Packing	2	4.5kg	4.7kg	0.0031	510x175x35mm
13.174	 	500x145mm		2u x 	

'S' BASE



BASE DETAILS

DIMENSIONS *mm

INFORMATION

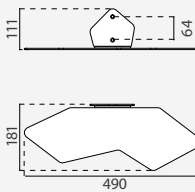

These bases are made of 4mm thick steel and has a grey color (RAL 9006). It can be used in 2 ways (in or out). **Protective rounded foam pads and the screws** are included.

	QTY	N.W	G.W	C.B.M	SIZE
Packing	2	4.19kg	4.50kg	0.0126	521x200x121mm
13.474	490x181x111mm		2u x 		

ASYMMETRIC BASE

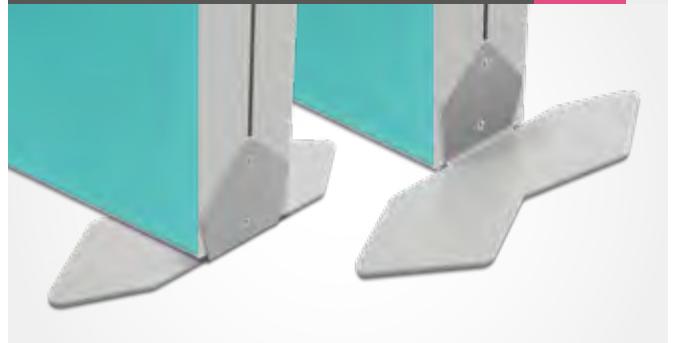

BASE DETAILS

DIMENSIONS *mm

INFORMATION

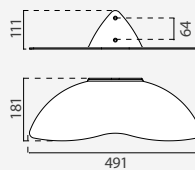

These bases are made of 4mm thick steel and has a grey color (RAL 9006). It can be used in 2 ways (in or out). **Protective rounded foam pads and the screws** are included.

	QTY	N.W	G.W	C.B.M	SIZE
Packing	2	4.77kg	5.07kg	0.0126	521x200x121mm
13.480	491x181x111mm		2u x 		

BUTTERFLY BASE



SUPPORT DETAILS

INFORMATION

*mm

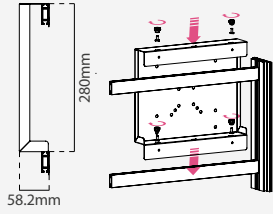

This TV support is suitable for using with 100mm TexFix® profiles. Very simple set up. It hangs from Central Reinforcement and adjusts thanks its screws (included).

	QTY	N.W	G.W	C.B.M	SIZE
Packing	1	1.67kg	1.95kg	0.0084	365x355x65mm
13.597		352x325x57mm			1u x 

TV SUPPORT FOR TEXFIX 100mm



HOLDER DETAILS

DIMENSIONS

*mm

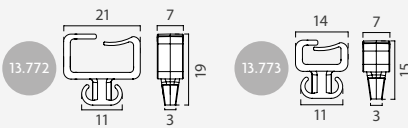

	QTY	N.W	G.W	C.B.M	SIZE
Packing	20	0.016kg	0.25kg	0.0003	170x100x15mm
13.772		21x19x7mm			20u x 
Packing	20	0.008kg	0.015kg	0.0003	170x100x15mm
13.773		14x15x7mm			20u x 

CABLE HOLDER FOR TEXFIX

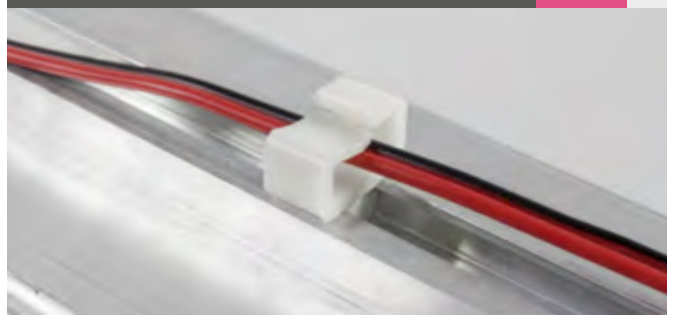



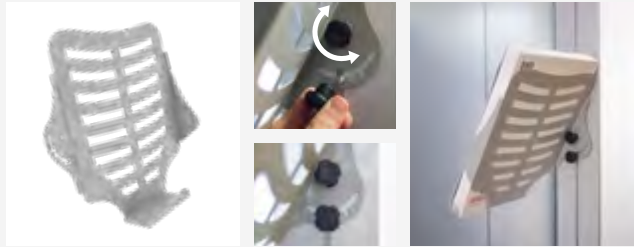





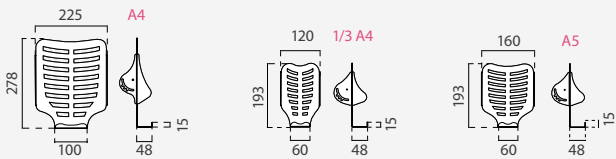



TRAY DETAILS



DIMENSIONS

*mm



REF	SIDE	FORMAT	PACK
13.444	Left	A4	 2u x 
13.445	Right	A4	 2u x 
13.440	Left	1/3 A4	 2u x 
13.441	Right	1/3 A4	 2u x 
13.442	Left	A5	 2u x 
13.443	Right	A5	 2u x 

STEEL TRAY FOR TEXFIX



POP UP DETAILS

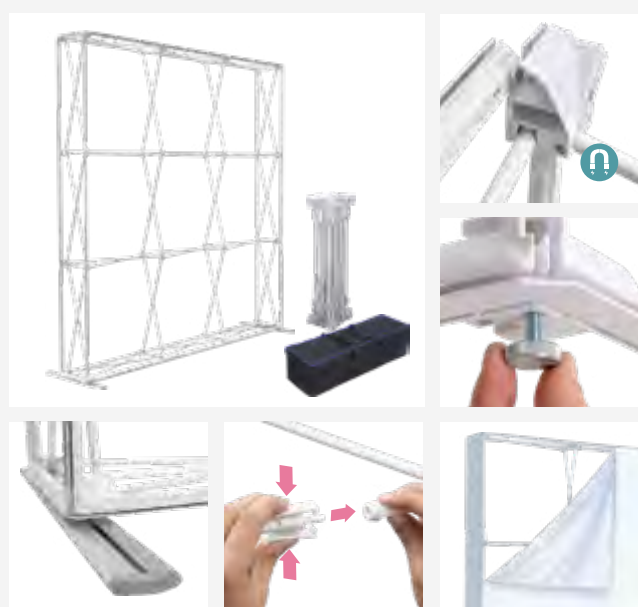

DIMENSIONS

*mm

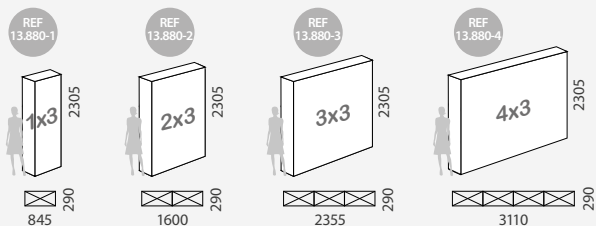

INFORMATION

Featuring a quick assembly white aluminium frame with magnetic bars for silicone edge textile graphics. Includes 2 attachable feet, silicone strip roll and bag. It can be turn into an backlit display with the optional LED Strip and Power Adapter (sold separately).

	QTY	N.W	G.W	C.B.M	SIZE
Packing	1	11kg	12kg	0.084	265x320x990mm
13.880-1	Graphic Sizes	Front-Back: 795x2215mm Sides: 275x2215mm Top-Bottom: 785x250mm			
	QTY	N.W	G.W	C.B.M	SIZE
Packing	1	13kg	14kg	0.084	265x320x990mm
13.880-2	Graphic Sizes	Front-Back: 1525x2215mm Sides: 275x2215mm Top-Bottom: 1510x250mm			
	QTY	N.W	G.W	C.B.M	SIZE
Packing	1	15.1kg	16.10kg	0.084	265x320x990mm
13.880-3	Graphic Sizes	Front-Back: 2255x2215mm Sides: 275x2215mm Top-Bottom: 2235x250mm			
	QTY	N.W	G.W	C.B.M	SIZE
Packing	1	17kg	18kg	0.084	265x320x990mm
13.880-4	Graphic Sizes	Front-Back: 2985x2215mm Sides: 275x2215mm Top-Bottom: 2960x250mm			

SEG POP UP

NEW



* The printing is not included in the price, but it is available separately. Please, request us.

SEG POP UP SIZE	1x3	2x3	3x3	4x3	RECOMMENDED QUANTITIES*
Nº OF LED STRIPS	2	4	6	8	
Nº OF POWER ADAPTERS	1	1	2	2	

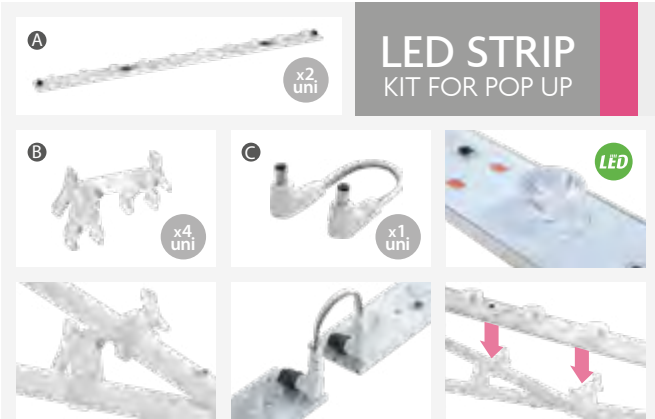

LED STRIP KIT FOR POP UP

INFORMATION

LED strip is the perfect solution to turn the SEG Pop Up into a backlight display. The set includes: 2 LED Strips **A** + 4 Clip Holders **B** + 1 Connect Cable **C**.

	QTY	N.W	G.W	C.B.M	SIZE
Packing	6	4.40kg	5.40kg	0.035	325x110x990
13.884	Length: 700mm		10 x 3.2W/LED	32W	



POWER ADAPTER SET

INFORMATION

This power adapter is compatible with 13.883 and 13.884. It has two different length output cables, one of 38cm and the other of 118cm. The set includes: 1 Power Adapter **A** + 1 Long Connect 2.3m Cable **B** + 6 Cable Clips **C**.

	QTY	N.W	G.W	C.B.M	SIZE
Packing	30	15kg	16kg	0.083	370x450x500mm
13.885	Input: 100-240V		Output: 24V/6.25A		



CARRY BAG FOR LED STRIPS

INFORMATION

Compatible with 13.883 and 13.884. Made of nylon and all crossed zipped features a custom cut EPE foam that protects and extends the life of your LED strips.

	QTY	N.W	G.W	C.B.M	SIZE
Packing	1	1kg	2kg	0.03	325x110x990mm
13.886	For 13.883 and 13.884 strips				

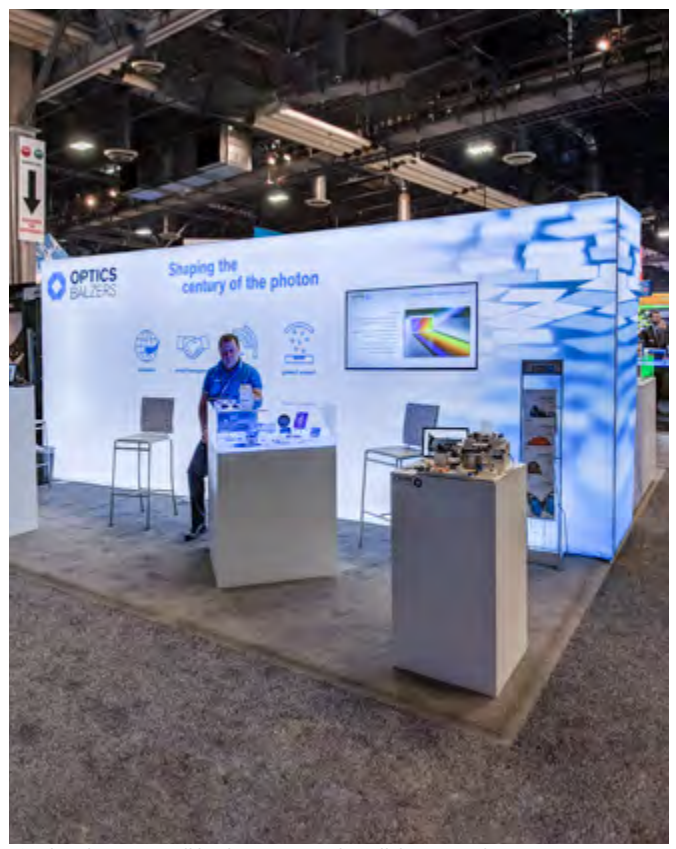

* The tablet stands at this page are available but are not included, see on the Chapter 6.

* Only indicative, it will be the customer who will determine the appropriate quantity.

TOTEM DETAILS



DIMENSIONS

*mm

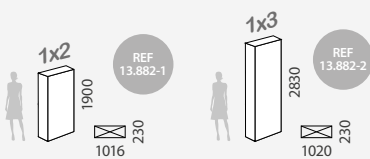

INFORMATION

Featuring a quick assembly white aluminium frame with magnetic bars for attaching silicone edge textile graphics. Includes 2 attachable feet, silicone strip roll and bag. Optional LED strip and Power Adapter (sold separately).

	QTY	N.W	G.W	C.B.M	SIZE
Packing	1	6.50kg	7.50kg	0.061	440x260x1080mm
13.882-1	Graphic Sizes	Front-Back: 1000x1890mm Sides: 240x1890mm Top-Bottom: 1000x240mm			
	QTY	N.W	G.W	C.B.M	SIZE
Packing	1	8.50kg	9.50kg	0.061	440x360x1080mm
13.882-2	Graphic Sizes	Front-Back: 1000x2830mm Sides: 240x2830mm Top-Bottom: 1000x240mm			



LED STRIP KIT FOR TOTEM & COUNTER



INFORMATION

This LED Strip Kit can be mounted in seconds thanks to its clip system. The LED Strip Kit includes: 2 LED Strips **A** + 4 Clip Holders **B**.

	QTY	N.W	G.W	C.B.M	SIZE
Packing	2	2.50kg	3.50kg	0.016	120x110x1215mm express
13.883	Length: 925mm	10 x 3.2W/LED	32W		

SEG TOTEM



POWER ADAPTER SET

INFORMATION

Compatible with 13.883 and 13.884. Includes: 1 Power Adapter **A** (with 2 output cables: 38cm and 118cm) + 1 Long Connect 2.3m Cable **B** + 6 Cable Clips **C**.

	QTY	N.W	G.W	C.B.M	SIZE
Packing	30	15kg	16kg	0.083	370x450x500mm
13.885	Input: 100-240V	Output: 24V/6.25A			



CARRY BAG FOR LED STRIPS

INFORMATION

Compatible with 13.883 and 13.884. Made of nylon and all crossed zipped features a custom cut EPE foam that protects and extends the life of your LED strips.

	QTY	N.W	G.W	C.B.M	SIZE
Packing	1	1kg	2kg	0.03	325x110x990mm
13.886	For 13.883 and 13.884 strips				

* The printing is not included in the price, but it is available separately. Please, request us.

COUNTER DETAILS



DIMENSIONS

*mm

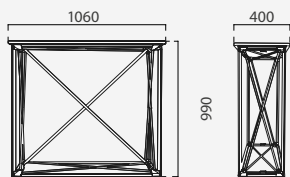

INFORMATION

SEG Counter features a white aluminium frame for attaching silicone edge textile graphics. Includes black or white countertop, silicone strip roll and carry bag. It can be turned into a backlit with the optional LED strip and Power Adapter (sold separately).

	QTY	N.W	G.W	C.B.M	SIZE
Packing	1	13.15kg	14.15kg	0.061	440x260x1080mm
13.881-1		Graphic Sizes	Front-Back: 1000x960mm Sides: 355x960mm Top-Bottom: 1000x355mm		
13.881-2					



LED STRIP KIT FOR TOTEM & COUNTER



INFORMATION

This LED Strip Kit can be mounted in seconds thanks to its clip system. The LED Strip Kit includes: 2 LED Strips **A** + 4 Clip Holders **B**.

	QTY	N.W	G.W	C.B.M	SIZE
Packing	2	2.50kg	3.50kg	0.016	120x110x1215mm
13.883	Length: 925mm	10 x 3.2W/LED	32W		

* The printing is not included in the price, but it is available separately. Please, request us.

SEG COUNTER



POWER ADAPTER SET

INFORMATION

Compatible with 13.883 and 13.884. Includes: 1 Power Adapter **A** (with 2 output cables: 38cm and 118cm) + 1 Long Connect 2.3m Cable **B** + 6 Cable Clips **C**.

	QTY	N.W	G.W	C.B.M	SIZE
Packing	30	15kg	16kg	0.083	370x450x500mm
13.885	Input: 100-240V	Output: 24V/6.25A			



CARRY BAG FOR LED STRIPS

INFORMATION

Compatible with 13.883 and 13.884. Made of nylon and all crossed zipped features a custom cut EPE foam that protects and extends the life of your LED strips.

	QTY	N.W	G.W	C.B.M	SIZE
Packing	1	1kg	2kg	0.03	325x110x990mm
13.886	For 13.883 and 13.884 strips				



DISPLAY DETAILS



DIMENSIONS

*mm

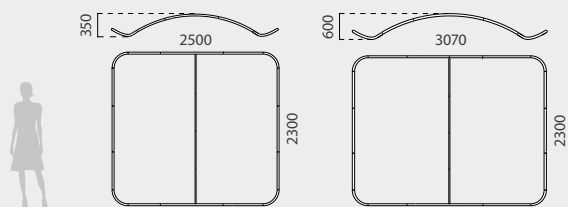

GRAPHIC FOR TEXTILE

*mm

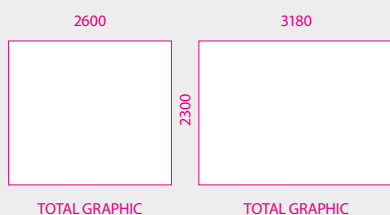

*Printed on textile.
Impression sur toile.
Impressão em tecido.
Impresión en tela.



INFORMATION

The Tension Display features a curved lightweight aluminum structure that assembles in a few minutes. A padded canvas carrying bag included for an easy storage and transportation. Denote your stand or photocall with the innovative design and versatility of textile printing. Ideal as a divider for a meeting or as a stand-alone photocall for advertisements and promotional events. The Kano Tension Textile Wall features a 3x3 or 4x3 ratio available.

KANO 1	QTY	N.W	G.W	C.B.M	SIZE
Packing	1	10.7kg	12.2kg	0.0284	240x160x740mm
15.220	Graphic Size: 2600x2300mm				
KANO 2	QTY	N.W	G.W	C.B.M	SIZE
Packing	1	12.7kg	14.2kg	0.0343	290x160x740mm
15.221	Graphic Size: 3180x2300mm				

KANO

“

Ideal for being used with Spotlights (not included)

”



* The printing is not included in the price, but it is available separately. Please, request us.

BAMAKO



“
Ideal for being used with
Spotlights (not included)
”



DISPLAY DETAILS



INFORMATION

The Bamako Tension Wall features a curved lightweight aluminum structure that assembles in a few minutes. A padded canvas carrying bag included for an easy storage and transportation. Create a 5280x2300mm big photocall with the innovative design and versatility of textile printing. Bamako is ideal for being used as divider for a meeting or as a stand-alone photocall for advertisements and promotional events. The Bamako Tension Textile Wall features a 7x3 ratio.

BAMAKO	QTY	N.W	G.W	C.B.M	SIZE
Packing	1	17.1kg	18.6kg	0.046	390x160x740mm
15.222	Graphic Size: 5420x2300mm				

DIMENSIONS

*mm

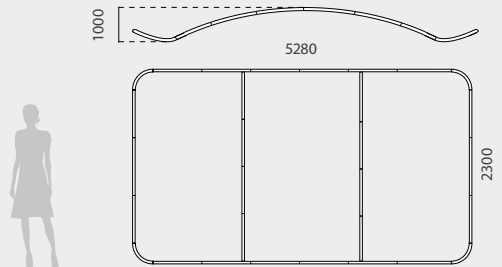

GRAPHIC FOR TEXTILE

*mm



TOTAL GRAPHIC

*Printed on textile.
Impression sur toile.
Impressão em tecido.
Impresión en tela.



* The printing is not included in the price, but it is available separately. Please, request us.

KAYES 2x3



 optional spotlight
- sold apart -



*Printed on textile.
Impression sur toile.
Impressão em tecido.
Impresión en tela.



EXTERNAL SIZE

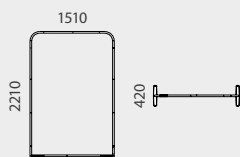

ARTWORK

*mm

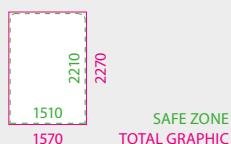

EXTERNAL SIZE

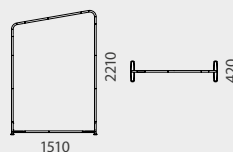

ARTWORK

*mm

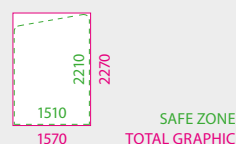

INFORMATION

Kayes features a 2x3 ratio, with a lightweight aluminum frame that assembles quickly. Carrying bag is included for an easy storage and transportation. 2 shapes available. Denote your stand or photocall with the innovative design and versatility of textile printing. Ideal as a divider or as photocall for advertisements and promotions.

KAYES 1	QTY	N.W	G.W	C.B.M	SIZE
Packing	1	15.1kg	17.6kg	0.022	190x160x740mm
15.223	Graphic Size: 1570x2270mm				

KAYES 2	QTY	N.W	G.W	C.B.M	SIZE
Packing	1	15.1kg	17.6kg	0.022	190x160x740mm
15.233	Graphic Size: 1570x2270mm				

EXTERNAL SIZE

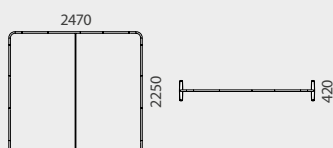

ARTWORK

*mm

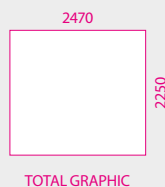

INFORMATION

Bilma features a 3x3 ratio, with a straight lightweight aluminum frame. Carrying bag is included for an easy storage and transportation. Denote your stand or photocall with the innovative design and versatility of textile printing. Ideal as a divider or as photocall for advertisements and promotions.

BILMA	QTY	N.W	G.W	C.B.M	SIZE
Packing	1	17.1kg	18.6kg	0.028	240x160x740mm
15.224	Graphic Size: 2470x2250mm				

* Custom textile printing in full color is available but not included.

BILMA 3x3



*Printed on textile.
Impression sur toile.
Impressão em tecido.
Impresión en tela.

* The printing is not included in the price, but it is available separately. Please, request us.

NIAMEY 4x3

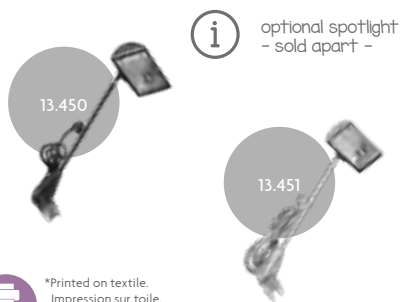

i optional spotlight
- sold apart -



*Printed on textile.
Impression sur toile.
Impressão em tecido.
Impresión en tela.

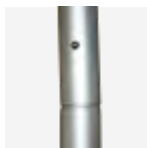

INFORMATION

Niamey features a 4x3 ratio, with a straight lightweight aluminum frame. Carrying bag is included for an easy storage and transportation. Denote your stand or photocall with the innovative design and versatility of textile printing. Ideal as a divider or as a photocall for advertisements and promotions.

NIAMEY	QTY	N.W	G.W	C.B.M	SIZE
Packing	1	12.7kg	14.2kg	0.034	290x160x740mm
15.225		Graphic Size: 2950x2250mm			

EXTERNAL SIZE

ARTWORK

*mm

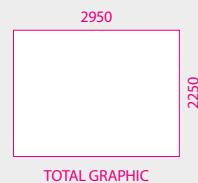
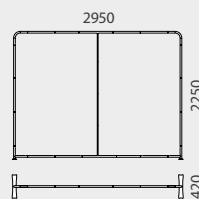

DAKAR 7x3

easy to assemble



*Printed on textile.
Impression sur toile.
Impressão em tecido.
Impresión en tela.

INFORMATION

Dakar features a large 7x3 ratio, with a straight lightweight aluminum frame. The graphic textile set attaches with a zipper underneath the frame for a seamless appearance. A canvas bag is included for an easy transportation. Denote your stand with the innovative design and versatility of the textile printing. Great for using at a trade show or at any media event.

DAKAR	QTY	N.W	G.W	C.B.M	SIZE
Packing	1	17.10kg	18.60kg	0.046	390x160x740mm
15.226		Graphic Size: 5830x2250mm			

EXTERNAL SIZE

ARTWORK

*mm

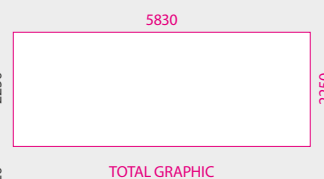
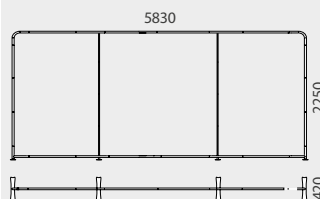

* The printing is not included in the price, but it is available separately. Please, request us.



ZAMBIA

“

Ideal for being used with Spotlights (not included)

”



13.450



13.451

denote your stand or photocal

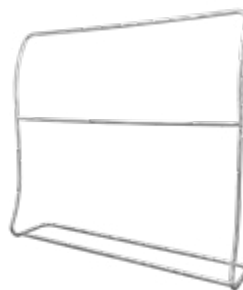

*Printed on textile.
Impression sur toile.
Impressão em tecido.
Impresión en tela.

INFORMATION

Zambia display features a lightweight aluminum frame that assembles in minutes. The graphic textile set attaches with a zipper underneath the frame for a seamless appearance. A canvas bag is included for an easy transportation. Denote your stand or photocal with the innovative design and versatility of the textile printing. Great for using at trade shows or at any media event.

ZAMBIA	QTY	N.W	G.W	C.B.M	SIZE
Packing	1	9.25kg	10.1kg	0.0463	310x180x830mm
15.219		Graphic Size: 2240x2860mm			

EXTERNAL SIZE

ARTWORK

*mm

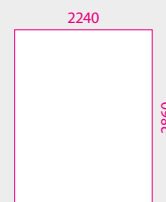
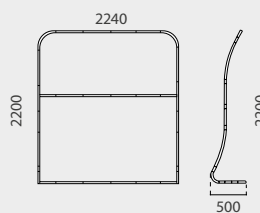

TOTAL GRAPHIC

* The printing is not included in the price, but it is available separately. Please, request us.

NAMIBIA

“
Ideal for being used with
Spotlights (not included)
”

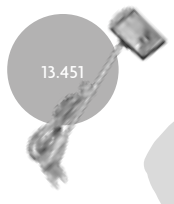

Ideal for a meeting point

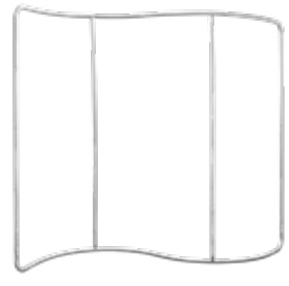

*Printed on textile.
Impression sur toile.
Impressão em tecido.
Impresión en tela.



INFORMATION

Namibia display features a curved lightweight aluminum frame. A padded canvas carrying bag included for an easy storage and transportation Denote your stand or tradebooth with the innovative design and versatility of textile printing. Ideal as a divider for a meeting or as a stand-alone photocall for advertisements and promotions at tradeshows or at any media event.

EXTERNAL SIZE

ARTWORK

*mm

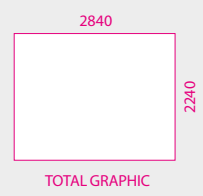
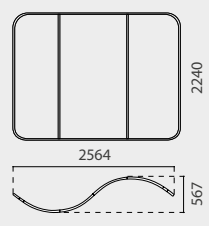

NAMIBIA	QTY	N.W	G.W	C.B.M	SIZE
Packing	1	9.4kg	10.3kg	0.0463	310x180x830mm
15.218	Graphic Size: 2840x2240mm				

* The printing is not included in the price, but it is available separately. Please, request us.

BANGUI

“

Ideal for being used with Spotlights (not included)

”



*Printed on textile.
Impression sur toile.
Impressão em tecido.
Impresión en tela.

INFORMATION

The Bangui display features a curved lightweight aluminum frame. Also a padded canvas carrying bag is included for an easy storage and transportation. Denote your tradebooth with the two useful wooden shelves included and the innovative design and versatility of textile printing. Great for using at trade shows or at any media event.

BANGUI	QTY	N.W	G.W	C.B.M	SIZE
Packing	1	15.95kg	16.90kg	0.0772	470x155x1060mm
15.215		Graphic Size: 2600x2200mm			

EXTERNAL SIZE

ARTWORK

*mm

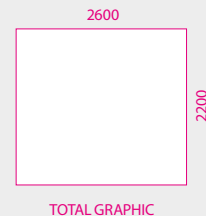
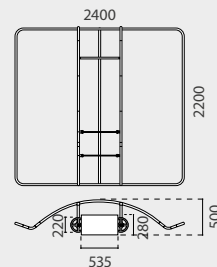

TOTAL GRAPHIC

* The printing is not included in the price, but it is available separately. Please, request us.

KENIA

“
Ideal for being used with
Spotlights (not included)
”



 *Printed on textile.
Impression sur toile.
Impressão em tecido.
Impresión en tela.

INFORMATION

Kenia display features a straight lightweight aluminum frame. A padded canvas carrying bag is included. The graphic textile set attaches with a zipper underneath the frame for a seamless appearance. Denote your stand with the safety holder for tablet and the three useful wooden shelves included. Ideal as a divider for a meeting, advertisements and promotions.

EXTERNAL SIZE

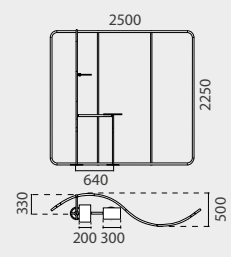

ARTWORK

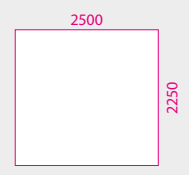

TOTAL GRAPHIC

KENIA	QTY	N.W	G.W	C.B.M	SIZE
Packing	1	16.55kg	17.65kg	0.0772	470x155x1060mm
15.213	Graphic Size: 2500x2250mm				

* The printing is not included in the price, but it is available separately. Please, request us.



MALI

“

Ideal for being used with Spotlights (not included)

”



Safety Holder for Tablet 244x184mm

* tablet not included

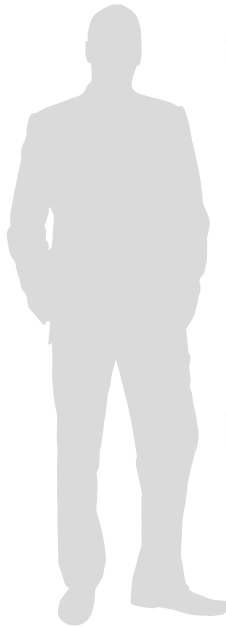

*Printed on textile.
Impression sur toile.
Impressão em tecido.
Impresión en tela.

INFORMATION

Mali tension display features a straight lightweight aluminum frame. A padded canvas carrying bag included for an easy storage and transportation. Denote your stand with the safety holder for tablet included and the innovative design and versatility of textile printing. Ideal as a divider for a meeting, advertisements and promotions.

MALI	QTY	N.W	G.W	C.B.M	SIZE
Packing	1	13.85kg	14.95kg	0.0772	470x155x1060mm
15.214		Graphic Size: 2470x2225mm			

EXTERNAL SIZE

ARTWORK

*mm

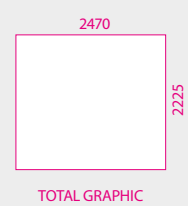
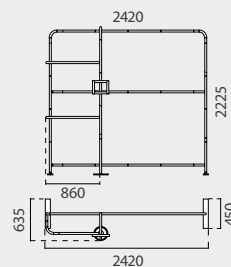

TOTAL GRAPHIC

* The printing is not included in the price, but it is available separately. Please, request us.

BURKINA

“

Ideal for being used with Spotlights (not included)

”



Safety Holder for Tablet 244x184mm

* tablet not included



*Printed on textile.
Impression sur toile.
Impressão em tecido.
Impresión en tela.

INFORMATION

Burkina display features a straight lightweight aluminum frame. A padded canvas carrying bag included for an easy storage and transportation. Denote your stand with the safety holder for tablet and the two useful wooden shelves included. Ideal for using as a divider for a meetin or as a photocall for advertisements and promotions at trade shows or at any media event.

BURKINA	QTY	N.W	G.W	C.B.M	SIZE
Packing	1	15.90kg	16.10kg	0.0772	470x155x1060mm
15.216	Graphic Size: 1400x2200mm				

EXTERNAL SIZE

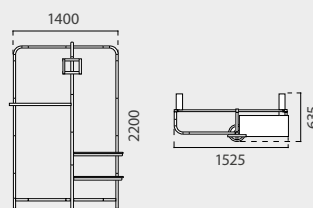

ARTWORK

*mm

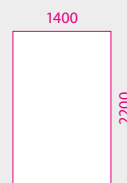

TOTAL GRAPHIC

* The printing is not included in the price, but it is available separately. Please, request us.



ITACA WALL ROOM

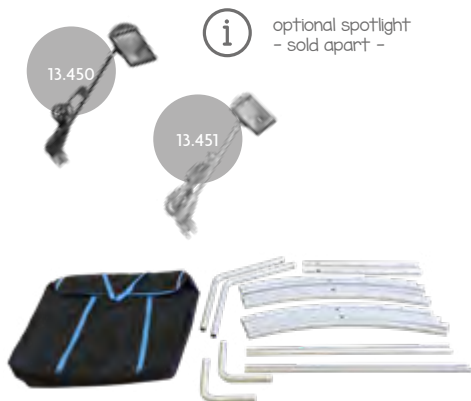

i optional spotlight - sold apart -



Ideal as a meeting point



*Printed on textile.
Impression sur toile.
Impressão em tecido.
Impresión en tela.

INFORMATION

Itaca display features a lightweight aluminum wall that assembles in minutes. The graphic textile set attaches with a zipper underneath the frame for a seamless appearance. A canvas bag is included for an easy transportation. Denote your stand or photocall with the innovative design and versatility of the textile printing. Great for using at trade shows or at any media event., this event fixture features enough space for setting up counters, chairs or any display and create a conference environment for your bussines. Ideal for meeting one-on-one with potential customers at a trade show.

ITACA	QTY	N.W	G.W	C.B.M	SIZE
Packing	1	9.5kg	10kg	0.09	1100x300x300mm
15.255		Graphic Size: 4860x2060mm			

EXTERNAL SIZE

ARTWORK

*mm

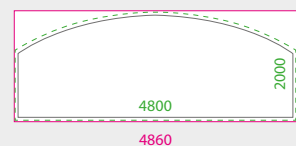
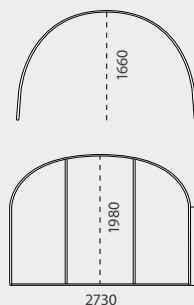

SAFE ZONE
TOTAL GRAPHIC

EXTERNAL SIZE

ARTWORK

*mm

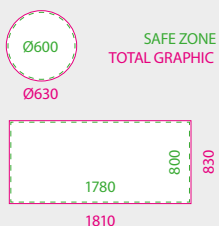
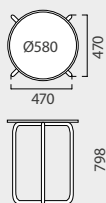

INFORMATION

The Delfos table features a Ø580mm wooden surface with a lightweight aluminum structure that assembles in minutes. The graphic textile set attaches with a zipper underneath the frame for a seamless appearance. A canvas bag is included. Ideal for being used with Itaca Wall.

DELFO	QTY	N.W	G.W	C.B.M	SIZE
Packing	1	6.6kg	7kg	0.0544	800x100x680mm
15.257		Graphic Size: 1810x830mm			

DELFO

TABLE



fast to set-up



*Printed on textile.
Impression sur toile.
Impressão em tecido.
Impresión en tela.

* The printing is not included in the price, but it is available separately. Please, request us.

TEBAS CHAIR

EXTERNAL SIZE ARTWORK *mm

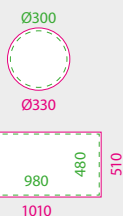
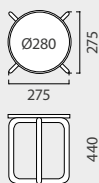

SAFE ZONE
TOTAL GRAPHIC

INFORMATION

The Tebas Chair features a Ø280mm wooden surface with a lightweight aluminum 440mm high structure that assembles in a few minutes. The graphic textile set attaches with a zipper. A canvas bag is included. Ideal for being used with Itaca Wall and Delfos Table.

TEBAS	QTY	N.W	G.W	C.B.M	SIZE
Packing	1	2.5kg	3kg	0.018	450x100x400mm
15.256		Graphic Size: 1010x510mm			



*Printed on textile.
Impression sur toile.
Impressão em tecido.
Impresión en tela.



* The printing is not included in the price, but it is available separately. Please, request us.



ALUMINIUM TUBULAR SYSTEM

 *Printed on textile.
Impression sur toile.
Impressão em tecido.
Impresión en tela.

INFORMATION *mm

This pack of 4 aluminium tubes for tubular system has Ø28mm diameter, it has 1mm of thickness and 3m length. The bars do not bring the holes made, so that the client can determine where to place them. Each pack comes with instructions included. Set up your own aluminum structure using these aluminum tubes with the connecting pieces of the tubular system. Ideal for tradeshows, media events or expositions.



1 (thickness)
Ø28

15.258	 4 Uni. x	3000mm	
--------	--	--------	--

ALUMINIUM TUBE Ø28 FOR TUBULAR SYSTEM

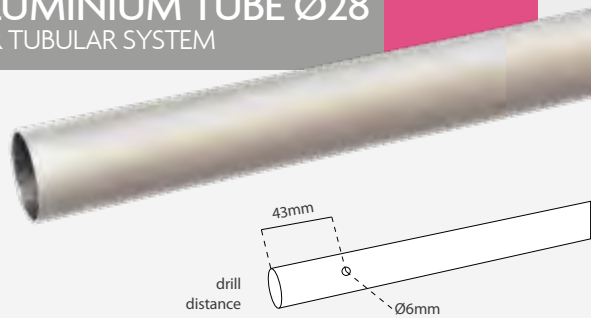

--	--	--	--

CORNER CONNECTION FOR TUBULAR SYSTEM

“T” CONNECTION FOR TUBULAR SYSTEM

CLIP STRIP FOR TUBULAR SYSTEM



INFORMATION *mm

This Corner connection piece is made of polycarbonate and it fits with aluminium tubes by the click system. Clip Strips are included.

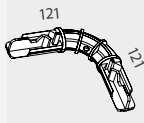

121

15.259	x4 		
--------	--	--	--

INFORMATION *mm

This “T” shape connection piece is made of polycarbonate and it fits with aluminium tubes by the click system. Clip Strips are included.

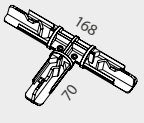



168
70

15.260	x2 		
--------	--	--	--

INFORMATION *mm

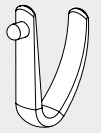
Pack of 10 plastic Clip Strip. This clip fits in tubular connections for the click system.



15.261	x10 		
--------	---	--	--

SET-UP INFORMATION

The multi-function Tubular System is designed to support several configurations applied by the customer, such as turning it into a Display Totem, a Barrier Banner or a Stand by using tension textil, panels or incorporating bases. Easy to assemble, each piece is designed for quick installation and use. Featuring 3m aluminum tubes without drilling for user's personalization (sold in pack of 4 units), Corner and "T" connections for setting-up structures and Clip Strips for connecting easily the aluminum tubes with corners and "Ts". Denote your stand or tradebooth with your own customizable display or stand. Ideal for setting-up dividers for a meeting or as a stand-alone photocall for advertisements and promotions at tradeshows or at any media event so is a practical display case that will look great in markets, shops, exhibition events or stores.

ALUMINIUM TUBULAR SYSTEM EXAMPLES



DISPLAY APPLICATIONS



* The printing is not included in the price, but it is available separately. Please, request us.

STAND APPLICATIONS



* Customization possibilities are orientative ideas, in no case are supplied with the display / * Les possible personnalisation sont à titre indicatif mais ne sont pas incluses dans le display.

* As possibilidades de personalização são orientativas, em nenhum caso são fornecidas com o artigo./ * Las posibilidades de personalización son orientativas, en ningún caso se suministran con el display.

MAPUKO



graphic size
700x1700mm

graphic size
800x1815mm



2 exhibition
modes



Fasteners available
(see accessories)



*Printed on textile.
Impression sur toile.
Impressão em tecido.
Impresión en tela.

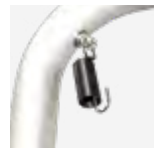

INFORMATION

Mapuko display features a straight lightweight aluminum frame. It features 2 exhibition modes available. Carrying bag is included. This 2-sided textile banner stand is an excellent upgrade to any trade show booth or event promotion.

MAPUKO	QTY	N.W	G.W	C.B.M	SIZE
Packing	1	3.95kg	4.45kg	0.0285	240x125x950mm
15.217		800x1815mm			700x1700mm

EXTERNAL SIZE

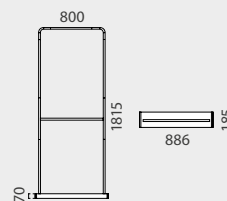

ARTWORK

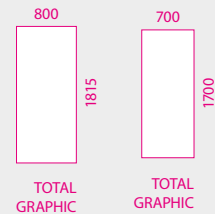

*mm

* The printing is not included in the price, but it is available separately. Please, request us.



THERA

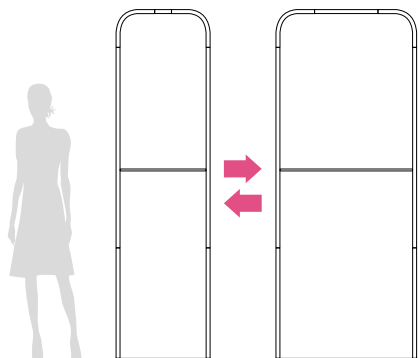

Fasteners available
(see accessories)



*Printed on textile.
Impression sur toile.
Impressão em tecido.
Impresión en tela.



+Online Shopping

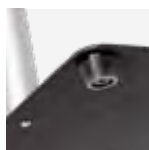
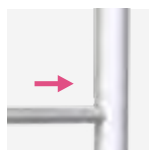

carry bag included



EXTERNAL SIZES & DOWNLOADABLES ARTWORKS (QR CODE)

*mm

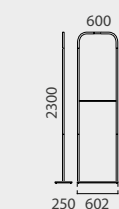

SAFE ZONE
TOTAL GRAPHIC

REF
15.245

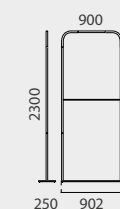
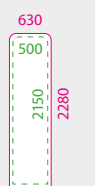

SAFE ZONE
TOTAL GRAPHIC

REF
15.246

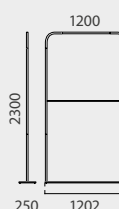
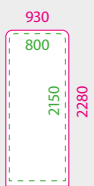

SAFE ZONE
TOTAL GRAPHIC

REF
15.247

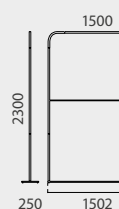
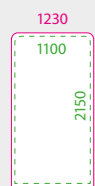

SAFE ZONE
TOTAL GRAPHIC

REF
15.248

INFORMATION

THERA features a linkable lightweight aluminum frame with stable base that assembles quickly. Carrying bag is included. Four widths available. Denote your stand or photocall with the innovative design and versatility of textile printing. Ideal as a divider or stand-alone photocall for advertisements and promotions.

THERA 60	QTY	N.W	G.W	C.B.M	SIZE
Packing	1	6.5kg	8.0kg	0.023	280x105x800mm
15.245	Graphic Size: 630x2280mm				
THERA 90	QTY	N.W	G.W	C.B.M	SIZE
Packing	1	8.5kg	10kg	0.027	280x105x950mm
15.246	Graphic Size: 930x2280mm				

THERA 120	QTY	N.W	G.W	C.B.M	SIZE
Packing	1	10.5kg	12.0kg	0.036	280x105x1250mm
15.247	Graphic Size: 1230x2280mm				
THERA 150	QTY	N.W	G.W	C.B.M	SIZE
Packing	1	12.5kg	14kg	0.045	280x105x1550mm
15.248	Graphic Size: 1530x2280mm				

* The printing is not included in the price, but it is available separately. Please, request us.

BOARD



lightweight



easy assembly



*Printed on textile.
Impression sur toile.
Impressão em tecido.
Impresión en tela.



INFORMATION

Board display features a curved lightweight aluminum frame that assembles in a few minutes. The graphic textile set is attached with a zipper underneath the frame for a seamless appearance. Carrying bag is included for an easy storage and transportation. Denote your stand with the innovative design and versatility of textile printing. Ideal for trade shows or promotional events.

BOARD	QTY	N.W	G.W	C.B.M	SIZE
Packing	1	4.10kg	4.75kg	0.07	800x260x320mm
15.236		Graphic Size: 530x2550mm			

EXTERNAL SIZE

ARTWORK

*mm

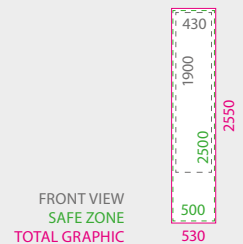
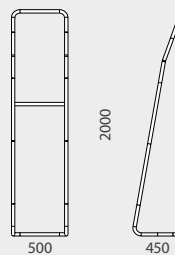

FRONT VIEW
SAFE ZONE
TOTAL GRAPHIC

* The printing is not included in the price, but it is available separately. Please, request us.

LEAF



great visual impact



sturdy wooden base



*Printed on textile.
Impression sur toile.
Impressão em tecido.
Impresión en tela.

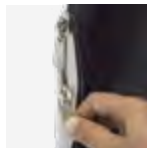

INFORMATION

This display features a leaf shape aluminum frame that assembles in a few minutes. The graphic textile set is attached with a zipper underneath the frame for a seamless appearance. Carrying bag is included for an easy storage and transportation. Denote your stand with the innovative design and versatility of textile printing. Ideal for trade shows or promotional events.

LEAF	QTY	N.W	G.W	C.B.M	SIZE
Packing	1	4.70kg	5.3kg	0.07	1150x140x430mm
15.237	Graphic Size: 960x2090mm				

EXTERNAL SIZE

ARTWORK

*mm

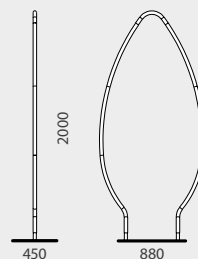

FRONT VIEW
SAFE ZONE
TOTAL GRAPHIC

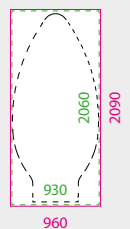

* The printing is not included in the price, but it is available separately. Please, request us.

SNAKE



quick assembly



*Printed on textile.
Impression sur toile.
Impressão em tecido.
Impresión en tela.

INFORMATION

Snake display features a curved lightweight aluminum frame that assembles in a few minutes. The graphic textile set is attached with a zipper underneath the frame for a seamless appearance. Carrying bag is included for an easy storage and transportation. Denote your stand with the innovative design and versatility of textile printing. Ideal for trade shows or promotional events.

SNAKE	QTY	N.W	G.W	C.B.M	SIZE
Packing	1	5kg	5.75kg	0.05	650x180x430mm
15.234		Graphic Size: 930x3190mm			

EXTERNAL SIZE

ARTWORK

*mm

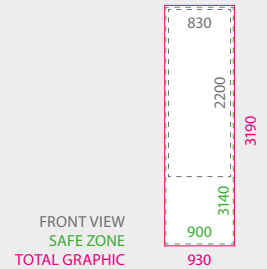
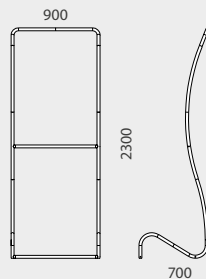

FRONT VIEW
SAFE ZONE
TOTAL GRAPHIC

* The printing is not included in the price, but it is available separately. Please, request us.

COBRA



Fast and simple set-up



*Printed on textile.
Impression sur toile.
Impressão em tecido.
Impresión en tela.



INFORMATION

Cobra display features a curved lightweight aluminum frame that assembles in a few minutes. The graphic textile set is attached with a zipper underneath the frame for a seamless appearance. Carrying bag is included for an easy storage and transportation. Denote your stand with the innovative design and versatility of textile printing. Ideal for trade shows or promotional events.

COBRA	QTY	N.W	G.W	C.B.M	SIZE
Packing	1	4.9kg	5.7kg	0.05	650x180x430mm
15.235		Graphic Size: 930x2750mm			

EXTERNAL SIZE

ARTWORK

*mm

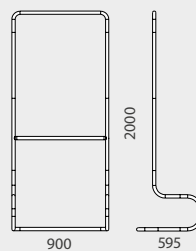

FRONT VIEW
SAFE ZONE
TOTAL GRAPHIC

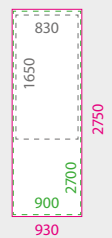

* The printing is not included in the price, but it is available separately. Please, request us.



DISPLAY DETAILS



EXTERNAL SIZE

ARTWORK

*mm

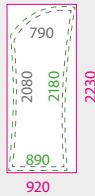

FRONT VIEW
SAFE ZONE
TOTAL GRAPHIC

INFORMATION

Aluminium Tension Textile Display stand with upper curved design. Teguise is an excellent addition to any tradeshow configuration. Available with shelves.

TEGUISE	QTY	N.W	G.W	C.B.M	SIZE
Packing	1	4.9kg	5.32kg	0.04	430x120x610mm
10.198		Graphic Size: 920x2230mm			

TEGUISE



*Printed on textile.
Impression sur toile.
Impressão em tecido.
Impresión en tela.

DISPLAY DETAILS



EXTERNAL SIZE

ARTWORK

*mm

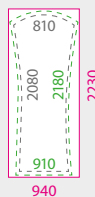
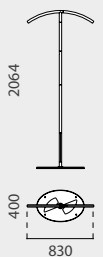

FRONT VIEW
SAFE ZONE
TOTAL GRAPHIC

INFORMATION

Aluminium Tension Textile Display stand with upper curved design. Arona is an excellent addition to any tradeshow configuration. Available with shelves.

ARONA	QTY	N.W	G.W	C.B.M	SIZE
Packing	1	4.9kg	5.32kg	0.04	430x120x610mm
10.205		Graphic Size: 940x2230mm			

ARONA



*Printed on textile.
Impression sur toile.
Impressão em tecido.
Impresión en tela.

* The printing is not included in the price, but it is available separately. Please, request us.

SIDEWALK DETAILS



double sided

REF 15.243

REF 15.242

TEXTILE

*Printing on fabric.
Impression sur toile.
Impressão em tecido.
Impresión en tela.

17 L

EXTERNAL SIZES & DOWNLOADABLES ARTWORKS (QR CODE)

*mm

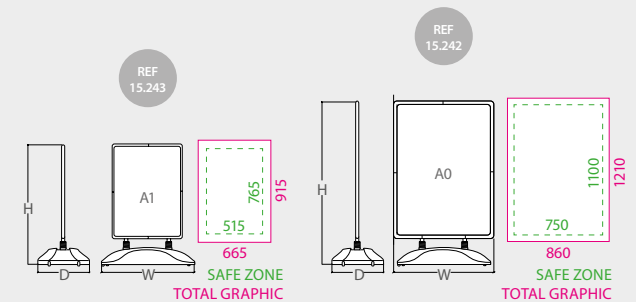

INFORMATION

The Mikonos Sidewalk features a lightweight aluminum structure with a refillable plastic base that assembles in seconds (It is 3.95kg weight and it can be filled with 17l of water or sand). Also, the Textile Boards are also simple to setup. All the aluminium poles fit together and snap into base. Simply stretch the wrap over the completed base and it's ready to use. The aluminium structure is affixed to the base with 2 large springs, so it stays stable in windy conditions. Built-in wheels also make this board easy to move as needed. A Nylon Carrying bag is included for an easy storage and transportation. Ideal for being used inside or outside of your restaurant, workshop, street stall, supermarket or heavily-trafficked areas such as tradeshows, events or conventions.

MIKONOS A1	QTY	N.W	G.W	C.B.M	Size (WxHxD)
Packing	1	7.5kg	9.5kg	0.11	510x950x230
	Visual (X-Y)		External (WxHxD)		
Product	A1 (665x915mm)	770x1120x480mm			

15.243 Graphic Size:665x915mm

MIKONOS A0	QTY	N.W	G.W	C.B.M	Size (WxHxD)
Packing	1	8kg	10kg	0.11	510x950x230
	Visual (X-Y)		External (WxHxD)		
Product	A0 (860x1210mm)	850x1450x480mm			

15.242 Graphic Size:860x1210mm

* The printing is not included in the price, but it is available separately. Please, request us.

MIKONOS



DISPLAY DETAILS



INFORMATION

*mm

Trade show display lighting adds the finishing touches needed to impress clients and to create effective presentations. This 150 W spotlight has a suitable fixing design for the tubular structures of the tension textile displays. Once in place, simply plug in the long cable to instantly add brightness. Stylish black or silver finish.

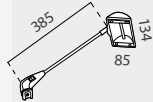

SPOTLIGHT	QTY	N.W	G.W	C.B.M	SIZE	
Packing	1	1kg	1.15kg	0.006	173x60x590mm	
13.450					Power: 150 W	
13.451					Power: 150 W	

SPOTLIGHT
FOR TENSION TEXTILE DISPLAY



FASTENER PIECES FOR
TENSION TEXTILE DISPLAY



REF 13.452

REF 13.453

TENSION TEXTILE STRIP

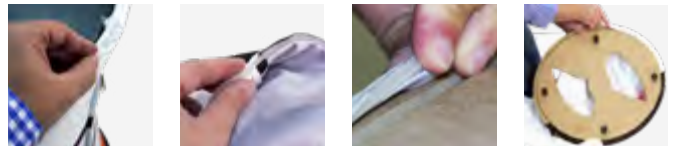

INFORMATION

*mm

Some Tension Textile Displays require that the set of textile graphics be made with a EVA strip around the perimeter so that these can be correctly introduced into their structures. This Tension Textile Strip is ideal for the manufacturing of textile for the Tension Display stands. It comes in 10m linear pack.

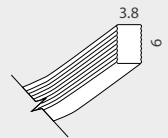

REF 13.465

INFORMATION

These fasteners connectors are specially designed for the tubular aluminum structure, making it ideal for joining Tension Textile Displays. 2 different rotating types of connection according to the model. Transparent finish for a complete integration with the Tension display.

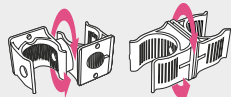

REF 13.452

REF 13.453

13.452		4.40 €
13.453		

13.465	Pack 10m/l	
--------	------------	--

* The printing is not included in the price, but it is available separately. Please, request us.



COUNTER DETAILS



*Printed on fabric.
Impression sur toile.
Impressão em tecido.
Impresión en tela.



BARACOA



EXTERNAL SIZE

ARTWORK

*mm

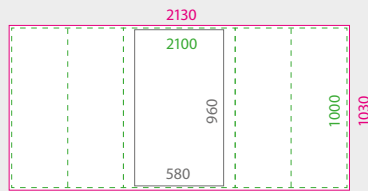
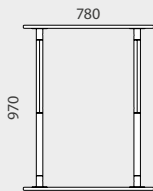

FRONT VIEW
SAFE ZONE
TOTAL GRAPHIC

INFORMATION

These Counters are designed for using with fabric wrap (printed on textile) making it lightweight and easy to fold. Also, the Fabric Counters are also simple to setup. All the aluminium poles fit together and snap into place. Simply stretch the wrap over the completed base and it's ready to use. With carry bag for easy travelling. Features a double zip to the interior of the counter for storing, so your exhibition always appears clean and organized. Baracoa is ideal as a lectern or podium at tradeshow, promotional events or conventions and are great to pair with Pop Up banners or any stand.

BARACOA	QTY	N.W	G.W	C.B.M	SIZE
Packing	1	8kg	9.2kg	0.042	860x120x410mm
13.740	Graphic Size: 2130x1030mm				



* The printing is not included in the price, but it is available separately. Please, request us.



COUNTER DETAILS



*Printed on fabric.
Impression sur toile.
Impressão em tecido.
Impresión en tela.

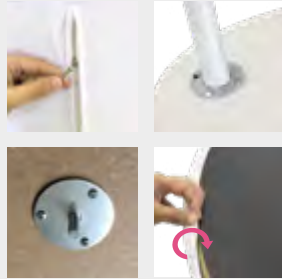

EXTERNAL SIZE

*mm

ARTWORK

DOWNLOAD

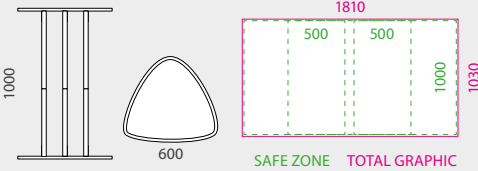

INFORMATION

Creta is lightweight and easy to fold and setup. With carry bag and a single zip to the interior for storing. Features 3 points of view. Ideal as a lectern or podium at tradeshows, events or conventions.

CRETA	QTY	N.W	G.W	C.B.M	SIZE
Packing	1	11kg	12kg	0.04	650x100x650mm
10.311	Graphic Size: 1810x1030mm				

CRETA



COUNTER DETAILS



*Printed on fabric.
Impression sur toile.
Impressão em tecido.
Impresión en tela.

automatic hydraulic



EXTERNAL SIZE

*mm

ARTWORK

DOWNLOAD

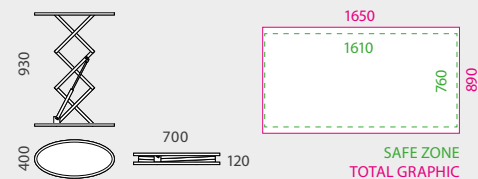

INFORMATION

Siena is lightweight and easy to fold and setup. With a hard carry padded bag and a double zip. Features an **hydraulic drive system** for an automatic and quick unfolding with just a slight push on the top of the counter. Ideal for events or conventions and are great to pair with Pop Up banners or any stand.

SIENA	QTY	N.W	G.W	C.B.M	SIZE
Packing	1	5.6kg	7.6kg	0.21	970x600x360mm
15.244	Graphic Size: 1650x890mm				

SIENA



* The printing is not included in the price, but it is available separately. Please, request us.



COUNTER DETAILS



*Printed on fabric.
Impression sur toile.
Impressão em tecido.
Impresión en tela.

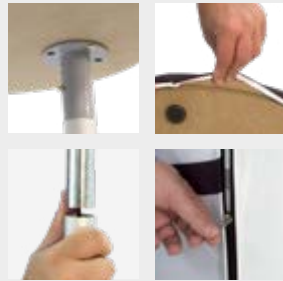

EXTERNAL SIZE *mm ARTWORK DOWNLOAD

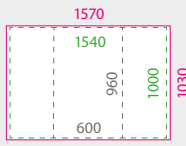
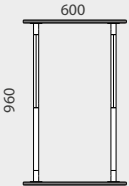

FRONT VIEW SAFE ZONE TOTAL GRAPHIC

INFORMATION

Manacor is lightweight and fast to setup. Features an oval shape design. With carry bag and a double zip to the interior for storing. Ideal as a lectern or podium at tradeshows, events or conventions.

MANACOR	QTY	N.W	G.W	C.B.M	SIZE
Packing	1	7.0kg	7.44kg	0.0366	440x130x640mm
10.318	Graphic Size: 1570x1030mm				

MANACOR



COUNTER DETAILS



*Printed on fabric.
Impression sur toile.
Impressão em tecido.
Impresión en tela.



EXTERNAL SIZE *mm ARTWORK DOWNLOAD

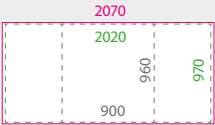
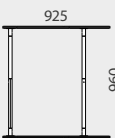

FRONT VIEW SAFE ZONE TOTAL GRAPHIC

INFORMATION

Mahon is lightweight and easy to assembly. Features the classic raindrop shape design. With carry bag and a double zip to the interior for storing. Ideal as a lectern or podium at promotional events, tradeshows, point of sales.

MAHON	QTY	N.W	G.W	C.B.M	SIZE
Packing	1	10.50kg	10.93kg	0.0672	500x140x960mm
10.319	Graphic Size: 2070x1000mm				

MAHON



* The printing is not included in the price, but it is available separately. Please, request us.

INDOOR FLAG BANNER

Indoor Flag Banner



EN Indoor Flag Banner. You can choose a flag banner base feet covered with an anti-scratch soft velvet finish. The price includes only the pole.

FR Drapeaux d'intérieure disponible en 6 modèles différents. Possibilité d'être utilisé un socle avec finition anti-rayures. Prix seulement du mât.

PT Bandeira para interior disponível em 6 modelos diferentes. A base, vendida por separado, tem um revestimento que evita riscos. Preço do mastro.

ES Flag Banner de interior. Puede combinarse con una base antideslizante provista de revestimiento anti-arañazos. El precio incluye sólo el poste.

FLAG DETAILS

ARTWORK *mm

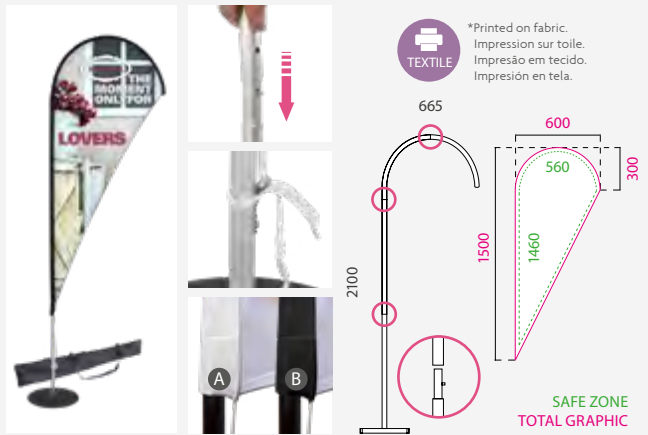

INFORMATION

It includes a carry nylon bag. Suitable for being used with indoor round base ref. 13.627. You can choose **A** white or **B** black colour of pole sheath.

TEARDROP	QTY	N.W	G.W	C.B.M	SIZE
Packing	1	0.50kg	0.65kg	0.0087	145x60x1000mm
13.621	Graphic: 600x1500mm		Safe: 560x1460mm		

TEARDROP



FEATHER

FLAG DETAILS

ARTWORK *mm

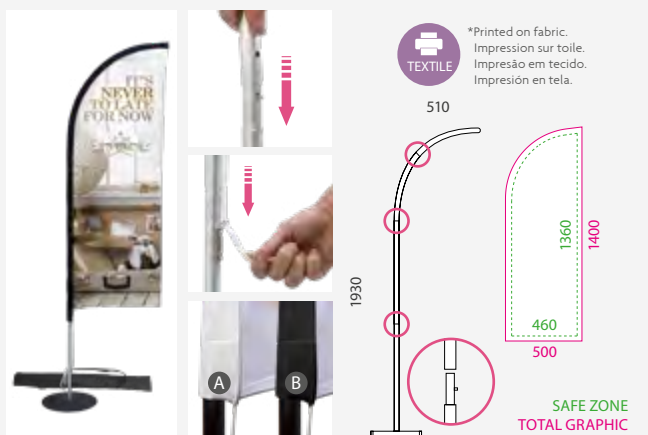

INFORMATION

It includes a carry nylon bag. Suitable for being used with indoor round base ref. 13.627. You can choose **A** white or **B** black colour of pole sheath.

FEATHER	QTY	N.W	G.W	C.B.M	SIZE
Packing	1	0.40kg	0.55kg	0.0087	145x60x1000mm
13.622	Graphic: 500x1400mm		Safe: 460x1360mm		

* The price includes only the flagpoles, not the bases.

SQUARED

FLAG DETAILS

ARTWORK *mm



INFORMATION

It includes a carry nylon bag. Suitable for being used with indoor round base ref. 13.627. You can choose **A** white or **B** black colour of pole sheath.

SQUARED	QTY	N.W	G.W	C.B.M	SIZE
Packing	1	0.40kg	0.55kg	0.0087	145x60x1000mm
13.623	Graphic: 500x1400mm		Safe: 460x1360mm		

* The printing is not included in the price, but it is available separately. Please, request us.

SENATOR

FLAG DETAILS

ARTWORK

*mm

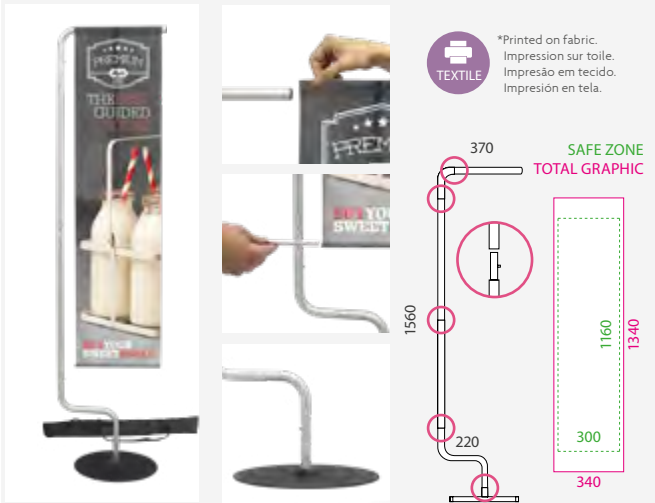

*Printed on fabric.
Impression sur toile.
Impressão em tecido.
Impresión en tela.



SAFE ZONE
TOTAL GRAPHIC

INFORMATION

It includes a carry nylon bag. Suitable for being used with indoor round base ref. 13.627. Ideal for supermarkets, shops or indoor promotional events.

SENATOR	QTY	N.W	G.W	C.B.M	SIZE
Packing	1	0.45kg	0.60kg	0.0087	145x60x1000mm
13.624	Graphic: 340x1340mm		Safe: 300x1160mm		

RAZOR

FLAG DETAILS

ARTWORK

*mm



*Printed on fabric.
Impression sur toile.
Impressão em tecido.
Impresión en tela.



SAFE ZONE
TOTAL GRAPHIC

INFORMATION

It includes a carry nylon bag. Suitable for being used with indoor round base ref. 13.627. You can choose **A** white or **B** black colour of pole sheath.

RAZOR	QTY	N.W	G.W	C.B.M	SIZE
Packing	1	0.45kg	0.60kg	0.0087	145x60x1000mm
13.625	Graphic: 625x1425mm		Safe: 585x1385mm		

KITE

FLAG DETAILS

ARTWORK

*mm



*Printed on fabric.
Impression sur toile.
Impressão em tecido.
Impresión en tela.



SAFE ZONE
TOTAL GRAPHIC

INFORMATION

It includes a carry nylon bag. Suitable for being used with indoor round base ref. 13.627. You can choose **A** white or **B** black colour of pole sheath.

KITE	QTY	N.W	G.W	C.B.M	SIZE
Packing	1	0.85kg	1.0kg	0.0087	145x60x1000mm
13.626	Graphic: 495x1300mm		Safe: 455x1260mm		

INDOOR ROUND BASE

FLAG DETAILS

DIMENSIONS

*mm



INFORMATION

25mm thickness base made of metal. With sided zipped black nylon carry bag with hand-strap included. Anti-Scratch finished.

REF	QTY	N.W	G.W	C.B.M	SIZE
Packing	1	1.10kg	1.20kg	0.00198	315x20x315mm
13.627	Diameter: Ø 300mm				

* The printing is not included in the price, but it is available separately. Please, request us.

* The Price includes only the flagpoles, not the bases.

HANGING SIGNS



Hanging Signs



EN

The Hanging Signs provide a great visual impact at long distance. With easy-assembly aluminium profiles and high-quality printed graphics where you can expose your message at height. Lightweight and easy to hang from the ceiling by wires. This system comes ready to be used anywhere. Supplied with mounting parts and carry bag.

FR

Les Hanging Signs ont un grand impact visuel. Profils en aluminium, très faciles à monter, et impression de qualité sur toile tendue permettent l'exposition rapide de messages en hauteur. Léger et facile à suspendre, ce système est idéal pour tous les espaces.

PT

Os Hanging Signs transmitem um grande impacto visual. Com perfis de alumínio e de montagem fácil, pode colocar uma mensagem em altura. Leve e fácil de pendurar, este sistema é adequado a qualquer espaço. Fornecido com peças de montagem e saco de transporte.

ES

Los Hanging Signs aportan un gran impacto visual a larga distancia. Con perfiles de aluminio fáciles de montar y una gráfica impresa de alta calidad donde puedes situar un mensaje en altura. Ligeros y fáciles de colgar mediante cables del techo. Este sistema viene preparado para emplearlo en cualquier lugar. Se suministra con piezas de montaje y bolsa de transporte.

HANGING SIGN SQUARE

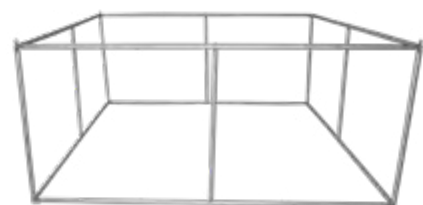

easy to hang
From ceiling by wires

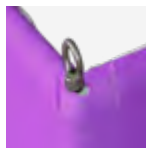
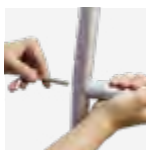
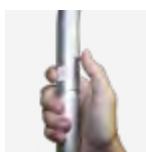

*Printed on textile.
Impression sur toile.
Impressão em tecido.
Impresión en tela.



EXTERNAL SIZE

*mm

REF 15.227

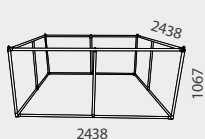

REF 15.228

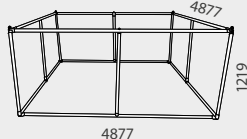

INFORMATION

This advertising overhead square banner can stand out anywhere. Use this hanging display to gain attention at conventions, even in a large exhibit hall, helping people locate a specific company or booth. Easy to hang from ceiling by wires. This entire display breaks down to fit into one bag for portability. Carry bag is included. The frame pieces easily pop into place for quick setup. Make a lasting impression at a convention with these displays. Two different sizes available.

SQUARE "S"	QTY	N.W	G.W	C.B.M	SIZE
Packing	1	10.5kg	13.6kg	0.1237	370x220x1520mm
15.227		External Size: 2438x1067mm			
SQUARE "M"	QTY	N.W	G.W	C.B.M	SIZE
Packing	1	16.3kg	19.7kg	0.14	370x220x1720mm
15.228		External Size: 4877x1219mm			



* The printing is not included in the price, but it is available separately. Please, request us.



HANGING SIGN CIRCLE



easy and fast assembly



lightweight aluminium profiles

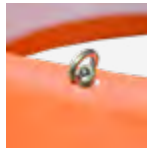

easy to hang from ceiling by wires



*Printed on textile.
Impression sur toile.
Impressão em tecido.
Impresión en tela.

EXTERNAL SIZE

*mm

REF 15.229

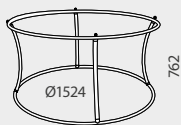

REF 15.230

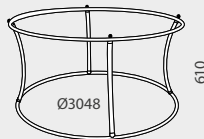

INFORMATION

This advertising overhead circular banner can stand out anywhere. Use this hanging display to gain attention at conventions, even in a large exhibit hall, helping people locate a specific company or booth. Easy to hang from ceiling by wires. This entire display breaks down to fit into one bag for portability. Carry bag is included. The frame pieces easily pop into place for quick setup. Make a lasting impression at a convention with these displays. Two different sizes available.

CIRCLE "S"	QTY	N.W	G.W	C.B.M	SIZE
Packing	1	5.5kg	7kg	0.0663	320x170x1220mm
15.229	(S)	External Size: 1524x762mm			
CIRCLE "M"	QTY	N.W	G.W	C.B.M	SIZE
Packing	1	16.3kg	19.7kg	0.14	370x220x1720mm
15.230	(M)	External Size: 3048x610mm			

* The printing is not included in the price, but it is available separately. Please, request us.

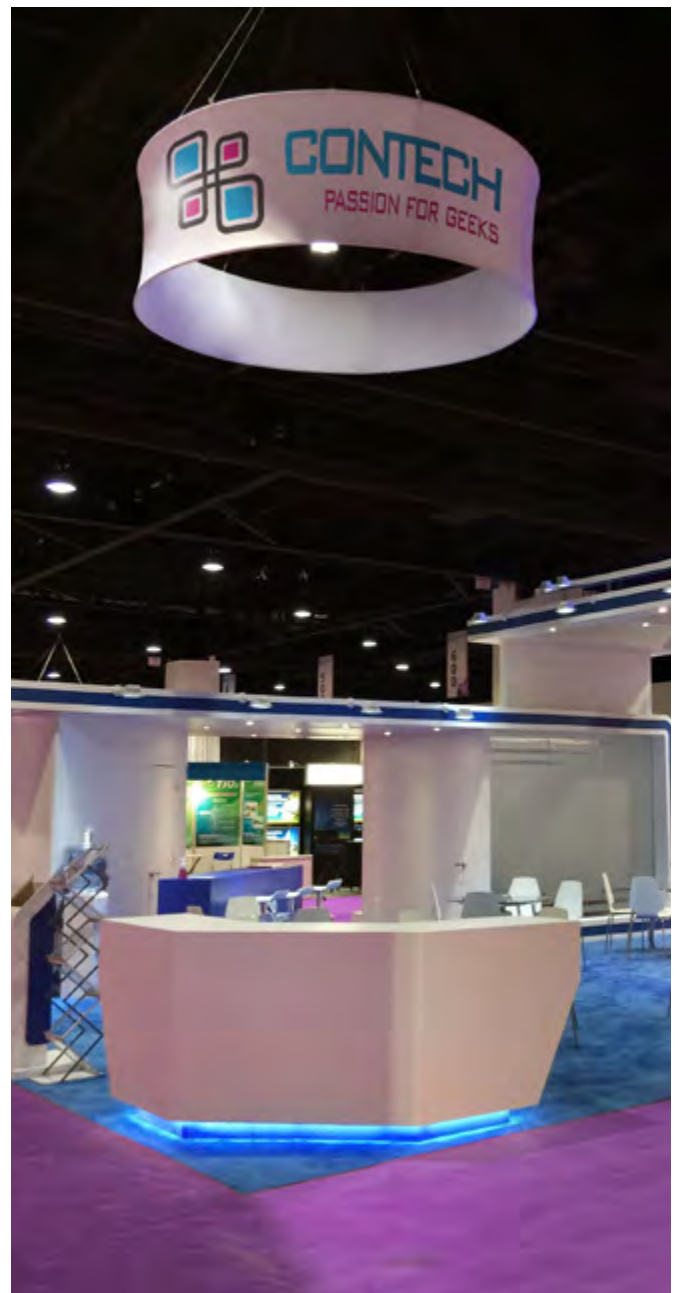



HANGING SIGN TAPERED CIRCULAR

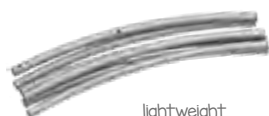

lightweight
aluminium profiles

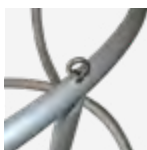
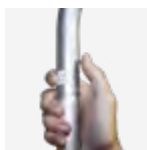

easy to hang from ceiling
by wires



*Printed on textile.
Impression sur toile.
Impressão em tecido.
Impresión en tela.



EXTERNAL SIZE

*mm



REF
15.231



REF
15.232

INFORMATION

This advertising overhead tapered banner can stand out anywhere. Use this hanging display to gain attention at conventions, even in a large exhibit hall, helping people locate a specific company or tradebooth. Easy to hang from ceiling by wires. This entire display breaks down to fit into one bag (included) for portability. The frame pieces easily pop into place for quick setup. Make a lasting impression at a convention with these displays. Two different sizes available.

T. CIRCLE "S"	QTY	N.W	G.W	C.B.M	SIZE
Packing	1	9.8kg	12.9kg	0.14	370x220x1720mm
15.231		External Size: Ø3048/2438x1067mm			
T. CIRCLE "M"	QTY	N.W	G.W	C.B.M	SIZE
Packing	1	12.4kg	15.8kg	0.14	370x220x1720mm
15.232		External Size: Ø4627/3658x1219mm			



* The printing is not included in the price, but it is available separately. Please, request us.



ROTATING STAND



4m

maximum height of 4m

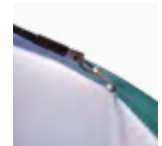

3 plug adapters included

Ø 44mm aluminium pole



400x400mm steel base



rotating 360° motor

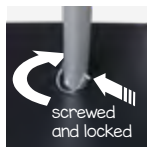
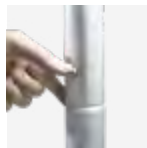

fiberglass sticks



also height can be customized by adding or removing aluminium poles



*Printed on textile.
Impression sur toile.
Impressão em tecido.
Impresión en tela.

screwed and locked



EXTERNAL SIZE

ARTWORK

*mm

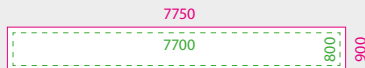
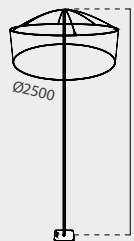

SAFE ZONE
TOTAL GRAPHIC

INFORMATION

The Rotating Stand provides a great visual impact at long distance. With easy-assembly aluminium poles and high-quality printed graphics where you can expose your message at height. This system comes ready to be used anywhere. Supplied with steel base, aluminium structure, fiberglass sticks, rotary 360° motor, power supply, plug adapters and carry bag. Use this display to gain attention at conventions or events, helping people locate a specific company or tradebooth.

ROTATING	QTY	N.W	G.W	C.B.M	SIZE
Packing	1	16.3kg	19.7kg	0.14	370x220x1720mm
15.254	Graphic Size: 7750x900mm				

* The printing is not included in the price, but it is available separately. Please, request us.





Signage

08

Complete range of signage holders for desktops, hanging from wall or ceiling which provide an integral solution for the selling exhibition.

- 354 SIGN HOLDERS
- 382 MOBILE SYSTEM
- 383 POSTER SYSTEM
- 392 DECORAIL
- 393 BUILDING SIGNS
- 400 STANDOFF
- 402 FIXINGS STANDOFF
- 409 OUTDOOR SIGN SYSTEM



HOLDER DETAILS

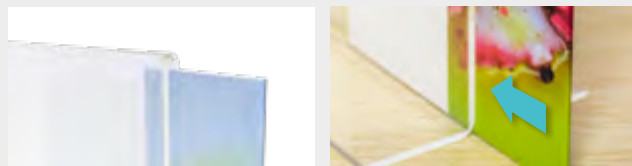

DIMENSIONS

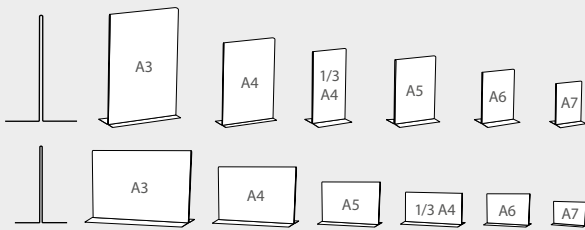

INFORMATION

This acrylic sign holder features an inverted "T" shape with portrait or landscape and 6 sizes for each orientation. Our sign holder is designed to hold two standard high sheets of paper back-to-back for double-sided viewing. Paper slips in easily through the bottom and sides. Ideal as marketing tool for a whole range of businesses. Schools, hospitals, real estate offices, coffee menus and retail stores.

"T" OPEN	PORTRAIT	THICKNESS				
13.069P	A3	2mm	x6	↑	↻	
13.027P	A4	2mm	x10	↑	↻	
13.028P	A5	2mm	x10	↑	↻	
13.068P	A6	2mm	x10	↑	↻	
13.147P	A7	2mm	x10	↑	↻	
13.148P	1/3 A4	2mm	x10	↑	↻	

"T" OPEN	LANDSCAPE	THICKNESS				
13.069L	A3	2mm	x6	↔	↻	
13.027L	A4	2mm	x10	↔	↻	
13.028L	A5	2mm	x10	↔	↻	
13.068L	A6	2mm	x10	↔	↻	
13.147L	A7	2mm	x10	↔	↻	
13.148L	1/3 A4	2mm	x10	↔	↻	

"T" OPEN SIGN HOLDER



HOLDER DETAILS

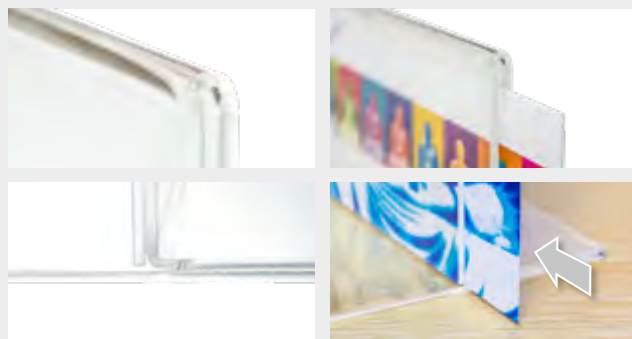

INFORMATION

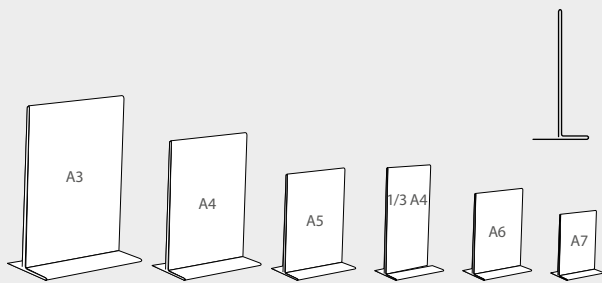

INFORMATION

This closed acrylic sign holder features an inverted "T" shape with 6 sizes available. Our sign holder is designed to hold two standard high sheets of paper back-to-back for double-sided viewing. Paper slips go in easily through the sides.

"T" CLOSED	PORTRAIT	THICKNESS			
13.000	A3	3mm	x6 		
13.001	A4	2mm	x10 		
13.002	A5	2mm	x10 		
13.003	A6	2mm	x10 		
13.350	A7	2mm	x10 		
13.351	1/3 A4	2mm	x10 		

"T" CLOSED SIGN HOLDER





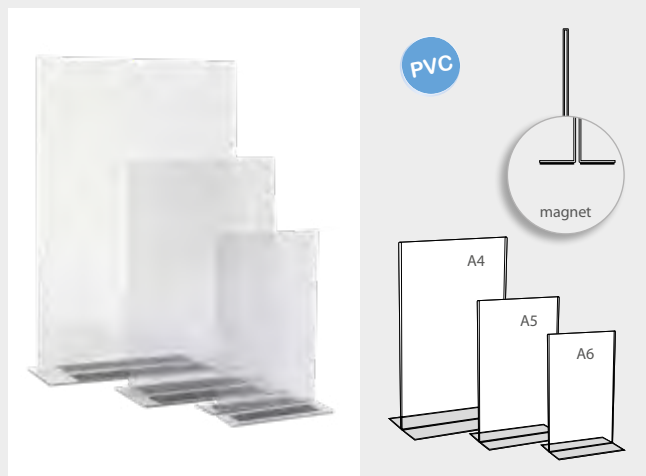









HOLDER DETAILS



INFORMATION

This open display is made of PVC and it features an inverted portrait "T" shape with 3 sizes. Also, it has 2 magnetic strips to fix it over metallic surfaces. This is ideal as marketing tool for a whole range of businesses.

"T" MAGNET	PORTRAIT	THICKNESS			
13.046	A4	0.7mm	x10 	  	
13.047	A5	0.7mm	x10 	  	
13.048	A6	0.7mm	x10 	  	

"T" MAGNET PVC HOLDER



HOLDER DETAILS

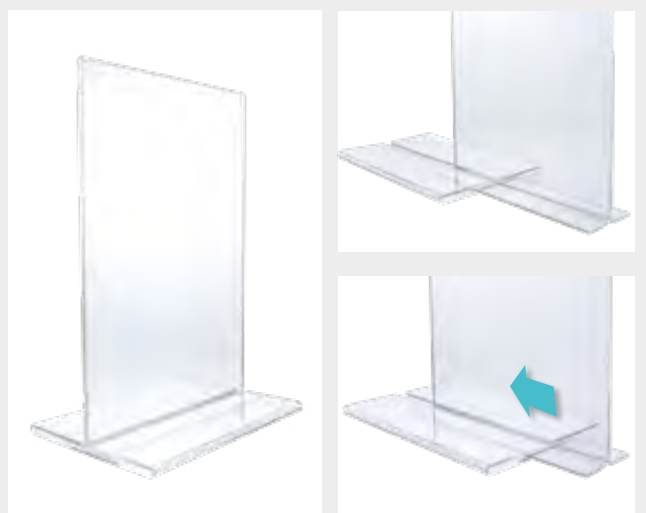

INFORMATION

This closed transparent Sign Holder has portrait orientation and it features an removable base, which you can take it off to get an easy change of the graphic.

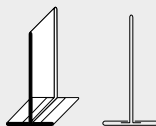

REMOVABLE	FORMAT	THICKNESS			
13.018	A4	2mm	x10 	 	
13.019	A5	2mm	x10 	 	

REMOVABLE BASE HOLDER









HOLDER DETAILS



INFORMATION

This magnetic display is made of Acrylic and it features an inverted portrait "T" shape with 3 sizes. Also, it has 2 magnetic strips to fix it over metallic surfaces. This is ideal as marketing tool for a whole range of businesses.

"T" MAGNET	PORTRAIT	THICKNESS			
13.841-1	A4	3mm	x5		
13.841-2	A5	3mm	x5		
13.841-3	A6	3mm	x5		

"T" MAGNET HOLDER



HOLDER DETAILS



INFORMATION

This display is made two pieces of 8mm acrylic with four magnets at corners for easy change of graphics. Can be used in portrait or landscape orientation, but landscape mode presents better stability.

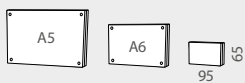

BLOCK MAGNET	PORTRAIT	THICKNESS			
13.843-1	A5	8mm	x6		
13.843-2	A6	8mm	x6		
13.843-3	95x65	8mm	x10		

ACRYLIC MAGNETIC BLOCK



HOLDER DETAILS

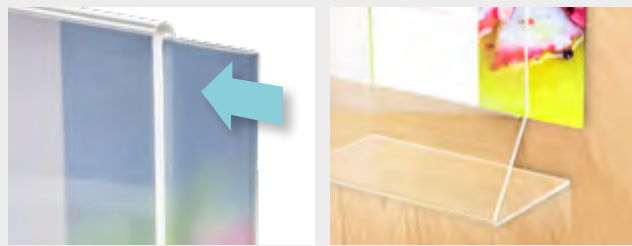

DIMENSIONS

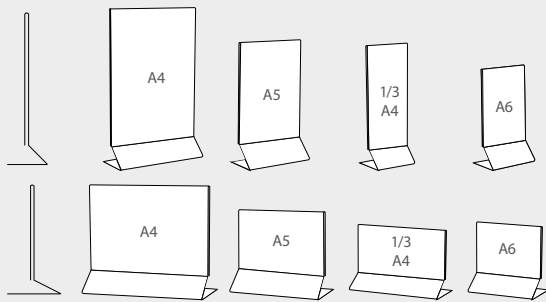

INFORMATION

This acrylic sign holder features a "Z" shape with portrait or landscape and 4 sizes for each orientation. Our sign holder is designed to hold two standard high sheets of paper back-to-back for double-sided viewing. Paper slips in easily through the bottom and sides. Ideal as marketing tool for a whole range of businesses. Schools, hospitals, real estate offices, coffee menus and retail stores.

"Z" OPEN	PORTRAIT	THICKNESS				
13.008P	A4	2mm	x10			
13.009P	A5	2mm	x10			
13.010P	A6	2mm	x10			
13.363P	1/3 A4	2mm	x10			

"Z" OPEN	LANDSCAPE	THICKNESS				
13.008L	A4	2mm	x10			
13.009L	A5	2mm	x10			
13.010L	A6	2mm	x10			
13.363L	1/3 A4	2mm	x10			

"Z" OPEN SIGN HOLDER

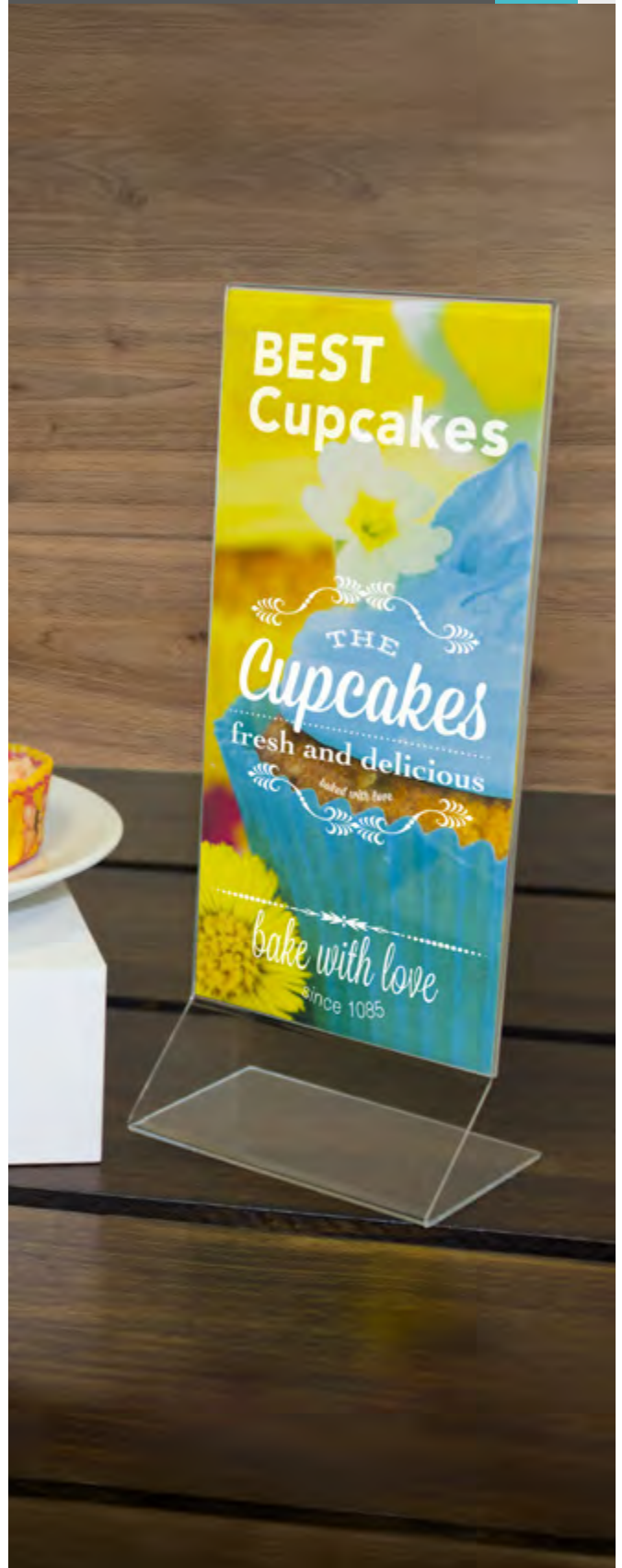

HOLDER DETAILS



DIMENSIONS

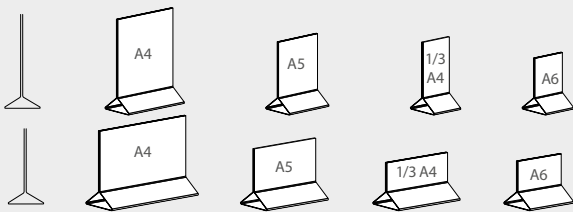

INFORMATION

This closed Menu Sign Holder with "Snake" shape has landscape and portrait orientation. 4 sizes of each are available. Paper slips in easily through the sides. It is ideal for schools, hospitals, real estate offices, coffee menus or retail stores.

"SNAKE"	PORTRAIT	Thickness				
13.364P	A4	2mm	x10			
13.365P	A5	2mm	x10			
13.366P	A6	2mm	x10			
13.367P	1/3 A4	2mm	x10			

"SNAKE"	LANDSCAPE	Thickness				
13.364L	A4	2mm	x10			
13.365L	A5	2mm	x10			
13.366L	A6	2mm	x10			
13.367L	1/3 A4	2mm	x10			

"SNAKE" SIGN HOLDER



HOLDER DETAILS



DIMENSIONS

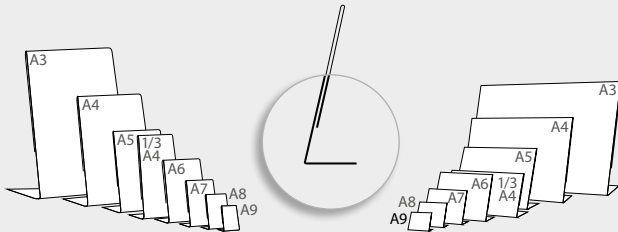

INFORMATION

This acrylic sign holder features an "L" shape with portrait or landscape and 8 sizes for each orientation. Our sign holder is designed to hold two standard high sheets of paper back-to-back for double-sided viewing. Paper slips in easily through the bottom and sides. Ideal as marketing tool for a whole range of businesses. Schools, hospitals, real estate offices, coffee menus and retail stores.

"L" SHAPE	PORTRAIT	THICKNESS				
13.004P	A3	3mm	x5			
13.005P	A4	2mm	x10			
13.006P	A5	2mm	x10			
13.007P	A6	2mm	x10			
13.352P	A7	2mm	x10			
13.353P	A8	2mm	x20			
13.354P	A9	2mm	x20			
13.355P	1/3 A4	2mm	x10			

"L" SHAPE	LANDSCAPE	THICKNESS				
13.004L	A3	3mm	x5			
13.005L	A4	2mm	x10			
13.006L	A5	2mm	x10			
13.007L	A6	2mm	x10			
13.352L	A7	2mm	x10			
13.353L	A8	2mm	x20			
13.354L	A9	2mm	x20			
13.355L	1/3 A4	2mm	x10			

"L" CLOSED SIGN HOLDER

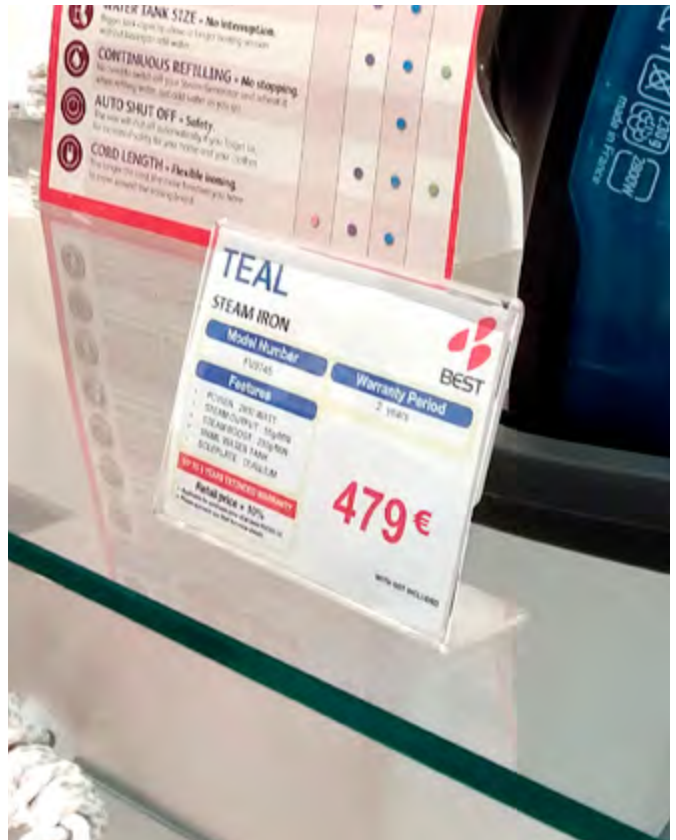

HOLDER DETAILS



PVC

INFORMATION

This open display is made of PVC and it features an "L" shape and 5 sizes with portrait orientation. Ideal as marketing tool for a whole range of businesses such as schools, hospitals, real estates offices, coffee menus or retail stores.

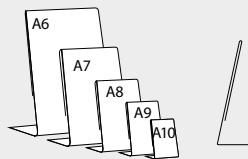

"L" PVC	PORTRAIT	THICKNESS			
13.356P	A6	0.4mm	x50	📏	📏
13.357P	A7	0.4mm	x50	📏	📏
13.358P	A8	0.4mm	x50	📏	📏
13.359P	A9	0.4mm	x50	📏	📏
13.360P	A10	0.4mm	x50	📏	📏

"L" PVC SIGN HOLDER



INFORMATION

This open display is made of PVC and it features an "L" shape and 5 sizes with portrait orientation. Ideal as marketing tool for a whole range of businesses such as schools, hospitals, real estates offices, coffee menus or retail stores.

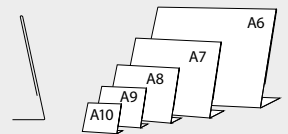

"L" PVC	LANDSCAPE	THICKNESS			
13.356L	A6	0.4mm	x50	📏	📏
13.357L	A7	0.4mm	x50	📏	📏
13.358L	A8	0.4mm	x50	📏	📏
13.359L	A9	0.4mm	x50	📏	📏
13.360L	A10	0.4mm	x50	📏	📏

HOLDER DETAILS



PVC

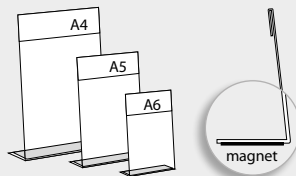

INFORMATION

This open display is made of PVC and it features an "L" shape with 3 sizes. Also, it has 2 magnetic strips to fix it over metallic surfaces. Ideal as marketing tool.

"L" MAGNET	PORTRAIT	THICKNESS			
13.049	A4	0.7mm	x10	📏	📏
13.050	A5	0.7mm	x10	📏	📏
13.051	A6	0.7mm	x10	📏	📏

"L" MAGNET PVC HOLDER



HOLDER DETAILS



DIMENSIONS

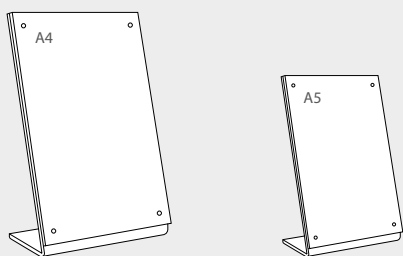

INFORMATION

This acrylic sign holder features an "L" shape with portrait orientation and 2 sizes available. This sign holder features a sandwich with two pieces of 4mm acrylic and 4 magnets at corners for easy change of graphics. Ideal as marketing tool for a whole range of businesses like Schools, hospitals, real estate offices, banks, coffee menus and retail stores.

"L" MAGNET	PORTRAIT	THICKNESS		
13.842-1	A4	4mm	x5 	 
13.842-2	A5	4mm	x5 	 

"L" MAGNETIC HOLDER



HOLDER DETAILS



DIMENSIONS

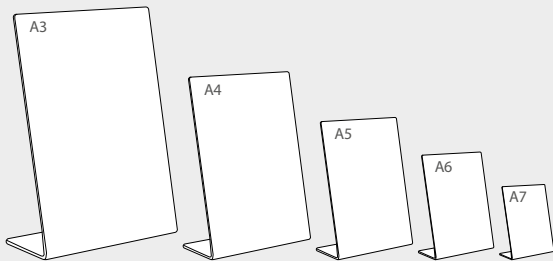

INFORMATION

This elegant display features an "L" shape with portrait orientation and 5 sizes available. This sign holder is made of 3mm black acrylic with the front face in matt finish and the back in gloss finish. Possibility of sticking a graphic on the front face. Ideal as marketing tool for a whole range of businesses like Schools, hospitals, real estate offices, banks, coffee menus and retail stores.

"L" BLACK	PORTRAIT	THICKNESS			
13.844-1	A3	3mm	x5		
13.844-2	A4	3mm	x10		
13.844-3	A5	3mm	x10		
13.844-4	A6	3mm	x10		
13.844-5	A7	3mm	x10		

"L" BLACK HOLDER



HOLDER DETAILS



DIMENSIONS

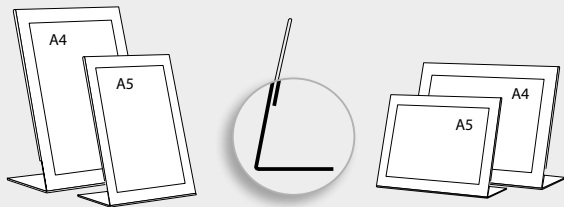

INFORMATION

This acrylic sign holder features an "L" shape with portrait or landscape and 2 sizes for each orientation. This Sign Holder features a black frame for a stylish finish and it is designed to hold two standard high sheets of paper back-to-back for double-sided viewing. Paper slips in easily through the bottom and sides. Ideal as marketing tool for a whole range of businesses. Schools, hospitals, real estate offices, banks, coffee menus and retail stores.

BLACK FRAME	ORIENTATION	THICKNESS	QUANTITY	FUNCTIONS
13.361P	A4	2mm	x5 	 
13.362P	A5	2mm	x5 	 
BLACK FRAME	ORIENTATION	THICKNESS	QUANTITY	FUNCTIONS
13.361L	A4	2mm	x5 	 
13.362L	A5	2mm	x5 	 

"L" BLACK FRAME HOLDER



HOLDER DETAILS



DIMENSIONS

*mm

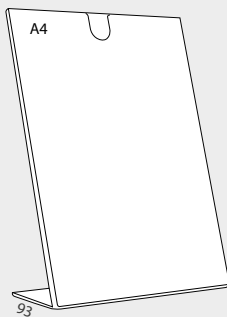

INFORMATION

This display features an "L" shape with portrait orientation for A4 size documents. This sign holder is made of transparent polystyrene with top loading graphic change. Ideal as marketing tool for a whole range of businesses like Schools, hospitals, real estate offices, banks, coffee menus and retail stores.

"L" HOLDER WITH OPENING

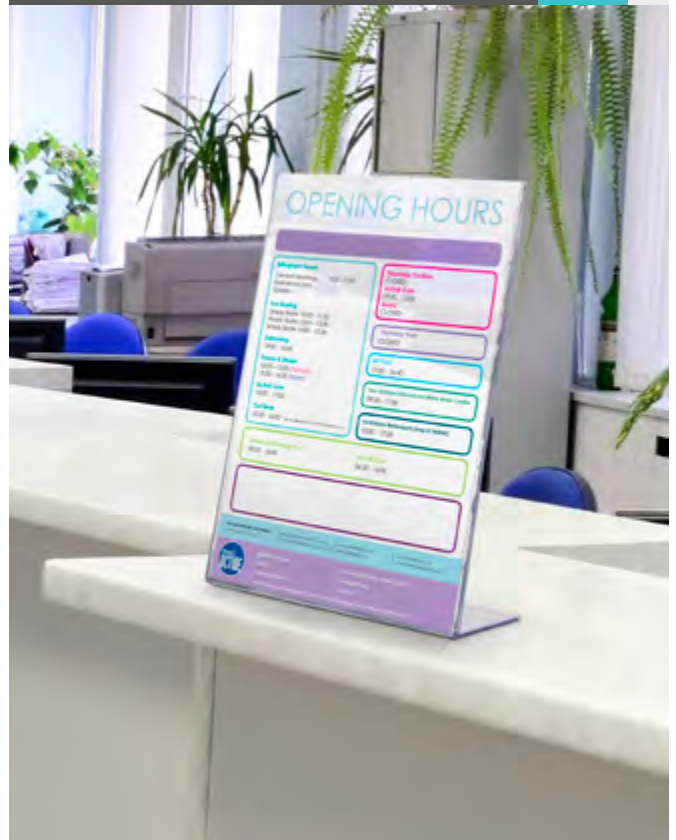

"L" MAGNET PORTRAIT THICKNESS

13.835

A4

2mm

x5 



HOLDER DETAILS *mm

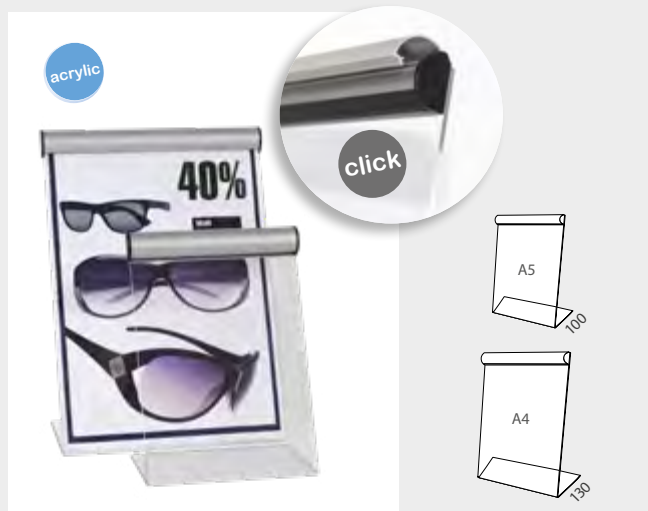

INFORMATION

This closed Sign Holder has an "L" shape and it features a snap top holder to fix the graphics. 2 portrait sizes available. This display is ideal for placing in hotels, schools, and lobby entrance ways for a unique and attention grabbing presentation.

"L" SNAP	PORTRAIT	THICKNESS			
13.384	A4	2mm	x5		
13.385	A5	2mm	x5		

"L" SNAP SIGN HOLDER



HOLDER DETAILS *mm



INFORMATION

This closed Sign Holder features an "L" shape and 2 sizes for documents with portrait orientation with a click system to fix the graphics. Two magnetic strips at the base included so it is ideal for placing on shelves or metallic structures at stores for a unique and attention grabbing presentation.

"L" SNAP	PORTRAIT	THICKNESS			
13.016	A4	2mm	x5		
13.017	A5	2mm	x5		

"L" SNAP MAGNET HOLDER



HOLDER DETAILS



DIMENSIONS

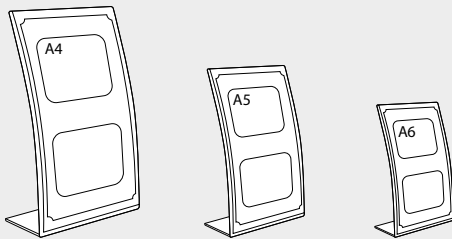

INFORMATION

This elegant display features an "L" shape with portrait orientation and 3 available sizes. This sign holder is made from strong plastic and is available with white surround. Comes with a non-reflective cover sheet. Ideal as marketing tool for a whole range of businesses like Schools, hospitals, real estate offices, banks, coffee menus and retail stores.

"L" CURVED	PORTRAIT	THICKNESS		
13.840-1	A4	3mm	x10 	 
13.840-2	A5	3mm	x10 	 
13.840-3	A6	3mm	x10 	 

"L" CURVED HOLDER

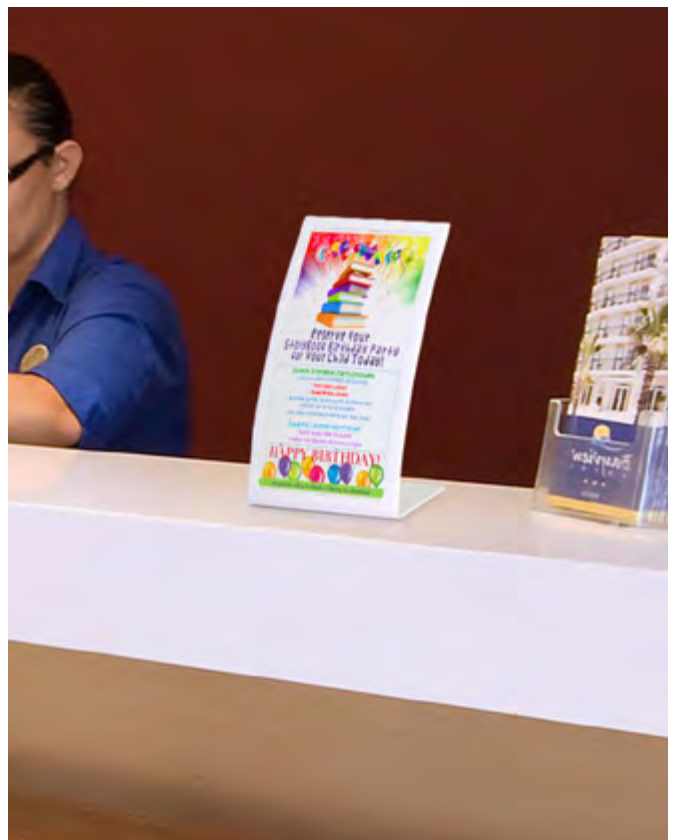

HOLDER DETAILS



acrylic

DIMENSIONS

*mm

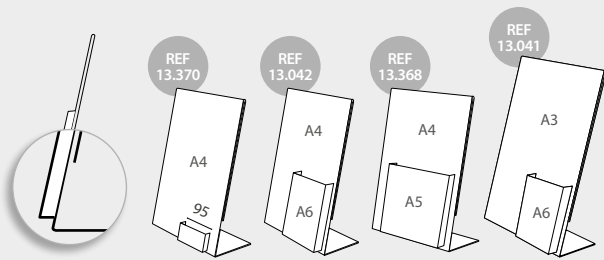

INFORMATION

This Closed Holder Display features an "L" shape for A4 or A3 format documents with portrait orientation. It features a brochure holders for showcards. Paper slips in easily through the sides. Ideal as marketing tool for a whole range of businesses. Schools, hospitals, real estate offices, banks, coffee menus and retail stores.

"L" + BROCHURE HOLDER



"L" DISPLAY	SIZE	THICKNESS					*mm
13.370	A4 + Showcard	2 (leaflet 2)	x5				
13.042	A4 + A6 Leaflet	3 (leaflet 2)	x5				
13.368	A4 + A5 Leaflet	2 (leaflet 2)	x5				
13.041	A3 + A6 Leaflet	3 (leaflet 2)	x5				

HOLDER DETAILS

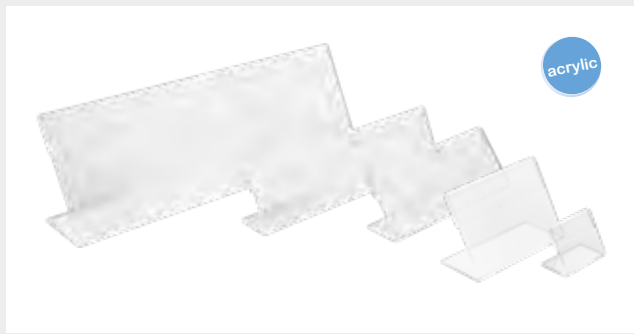

INFORMATION

* mm

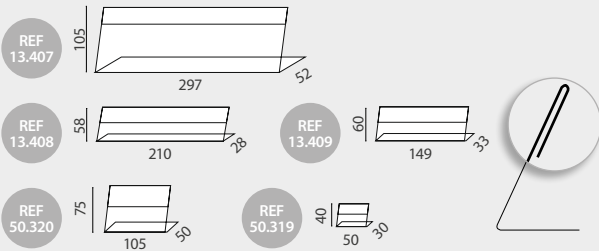

This Desktop Sign Holder has a "L" shape and it is made of 2mm thickness acrylic. 5 sizes available with landscape orientation. Paper slips in easily through the sides.

DESK	SIZE	THICKNESS			
13.407	297x105x52mm	2mm	x10		
13.408	210x58x28mm	2mm	x20		
13.409	149x60x33mm	2mm	x20		
50.320	105x75x50mm	2mm	x20		
50.319	50x40x30mm	2mm	x20		

DESK ACRYLIC SIGN



HOLDER DETAILS



INFORMATION

*mm

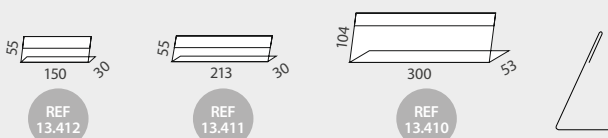

This transparent Desk Sign is made of 0.5mm thickness PVC, featuring 3 models available. It is ideal for displaying ID cards, directory signage or temporary notes.

DESK PVC SIGN	SIZE	THICKNESS			
13.410	300x104x53mm	0.5mm	x20		
13.411	213x55x30mm	0.5mm	x20		
13.412	150x55x30mm	0.5mm	x20		

DESK PVC SIGN

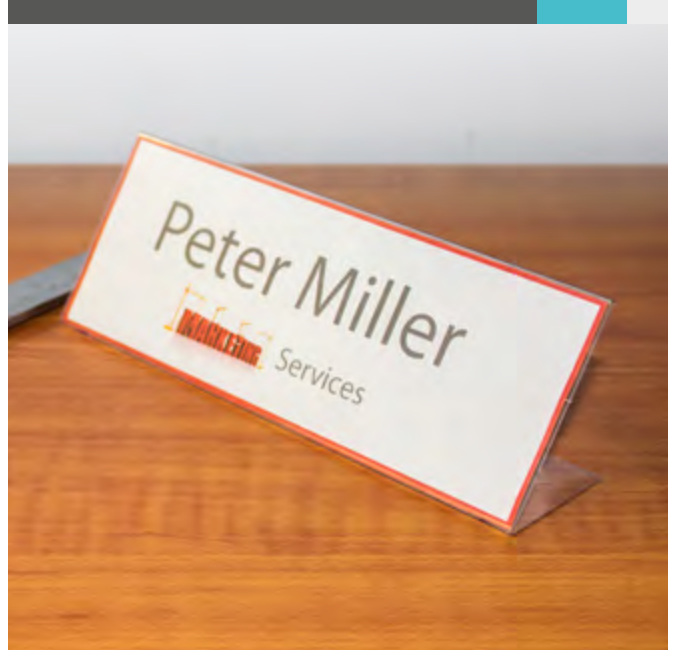

HOLDER DETAILS



INFORMATION



This Sign Holder Display is made of acrylic and has a tent portrait or landscape shape for double-sided viewing. Available in 4 sizes. Paper inserts in easily through the sides.

TENT	SIZE	THICKNESS			
13.029P	A4	2mm	x10		
13.030P	A5	2mm	x10		
13.031P	A6	2mm	x10		
13.032P	A7	2mm	x10		
"L" PVC	LANDSCAPE	THICKNESS			
13.029L	A4	2mm	x10		
13.030L	A5	2mm	x10		
13.031L	A6	2mm	x10		
13.032L	A7	2mm	x10		
13.033L	297x105mm	2mm	x10		

TENT ACRYLIC DISPLAY



HOLDER DETAILS



INFORMATION



This Sign Holder Display is made of PVC and has a tent portrait or landscape shape for double-sided viewing. Available in 4 sizes. Paper inserts in easily through the sides.

TENT PVC	SIZE	THICKNESS			
13.415P	A6	0.4mm	x50		
13.416P	A7	0.4mm	x50		
13.417P	A8	0.4mm	x50		
13.418P	A9	0.4mm	x50		
13.419P	A10	0.4mm	x50		
"L" PVC	LANDSCAPE	THICKNESS			
13.415L	A6	0.4mm	x50		
13.416L	A7	0.4mm	x50		
13.417L	A8	0.4mm	x50		
13.418L	A9	0.4mm	x50		
13.419L	A10	0.4mm	x50		

TENT PVC DISPLAY



HOLDER DETAILS



INFORMATION

*mm

This acrylic sign Holder with stylish rectangular wooden base is available in 3 sizes (A4, A5 and A6). It is designed for portrait orientation of graphics.

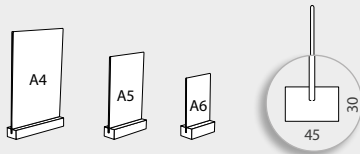

WOOD BASE PORTRAIT THICKNESS

WOOD BASE	PORTRAIT	THICKNESS			
13.011P	A4	2mm	x10	↑	📏
13.012P	A5	2mm	x10	↑	📏
13.013P	A6	2mm	x10	↑	📏

WOOD BASE HOLDER



INFORMATION

*mm

This acrylic sign Holder with stylish rectangular wooden base is available in 3 sizes (A4, A5 and A6). It is designed for portrait orientation of graphics.

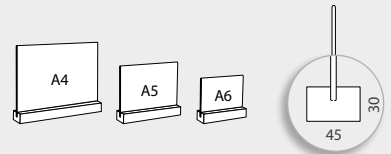

WOOD BASE LANDSCAPE THICKNESS

WOOD BASE	LANDSCAPE	THICKNESS			
13.011L	A4	2mm	x10	↔	📏
13.012L	A5	2mm	x10	↔	📏
13.013L	A6	2mm	x10	↔	📏

HOLDER DETAILS



INFORMATION

*mm

This acrylic sign Holder with stylish oval wooden base is available in 3 sizes (A4, A5 and A6). It is designed for portrait orientation of graphics.

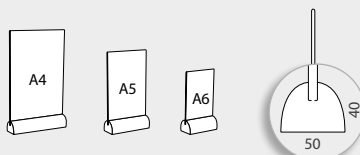

WOOD BASE PORTRAIT THICKNESS

WOOD BASE	PORTRAIT	THICKNESS			
13.391P	A4	2mm	x10	↑	📏
13.392P	A5	2mm	x10	↑	📏
13.393P	A6	2mm	x10	↑	📏

OVAL WOOD BASE HOLDER



INFORMATION

*mm

This acrylic sign Holder with stylish oval wooden base is available in 3 sizes (A4, A5 and A6). It is designed for portrait orientation of graphics.

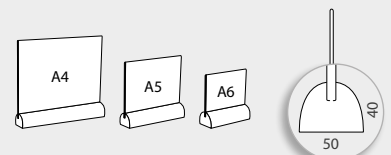

WOOD BASE LANDSCAPE THICKNESS

WOOD BASE	LANDSCAPE	THICKNESS			
13.391L	A4	2mm	x10	↔	📏
13.392L	A5	2mm	x10	↔	📏
13.393L	A6	2mm	x10	↔	📏

HOLDER DETAILS



INFORMATION

* mm

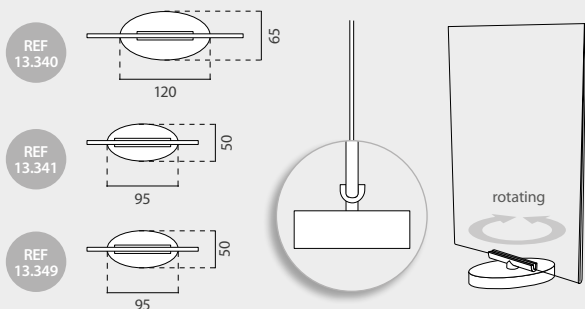

INFORMATION

This open sign frame features transparent panes with green tinted edges, providing the look of real glass. Rotating base with anti-scratch felt bottom pad. Available in 3 sizes with portrait orientation.

"SWIVEL"	PORTRAIT	THICKNESS		
13.340	A4	3mm	x2 	 
13.341	A5	3mm	x4 	 
13.349	1/3 A4	3mm	x4 	 

"SWIVEL"
LITERATURE HOLDER



DISPLAY DETAILS



DIMENSIONS

*mm

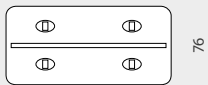

76

- Power/Discharging Indicator
- 1 micro USB input (5V/2.0A)
- 4 USB outputs (5V/2.0A)
- Total Output: 5V / 2.5A
- Capacity: 6.000 mA h
- Charge Time: ± 7-8 h

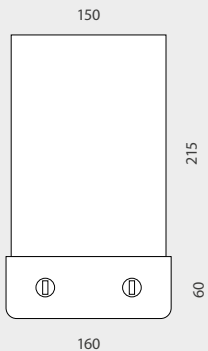

160

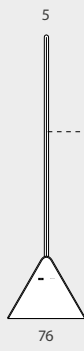

inner thickness: 2

4 USB PORTS

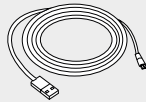

INFORMATION

This closed sign frame features a transparent acrylic sign holder and a black rubber coating base with 4 usb connectors. It supports charging 4 devices at the same time, so it is ideal for marketing tool and a good choice for the consumers, prolonging their stay in the establishment while they are charging their devices. The portable Powerbank can be charged via DC port or via micro USB. Featuring a Power and Discharging indicator. Also, it is able to charge most electronic devices with a charging voltage of 5.0V. To charge your electronic device, connect the USB output port on the Power Bank to the input port on your device using the provided cable. This Powerbank with unique design is ideal for restaurants, coffee shops, bar, for tea-shops, etc.

POWER BANK

GRAPHICK SIZE

13.572

215x150mm

x1



POWER BANK DISPLAY

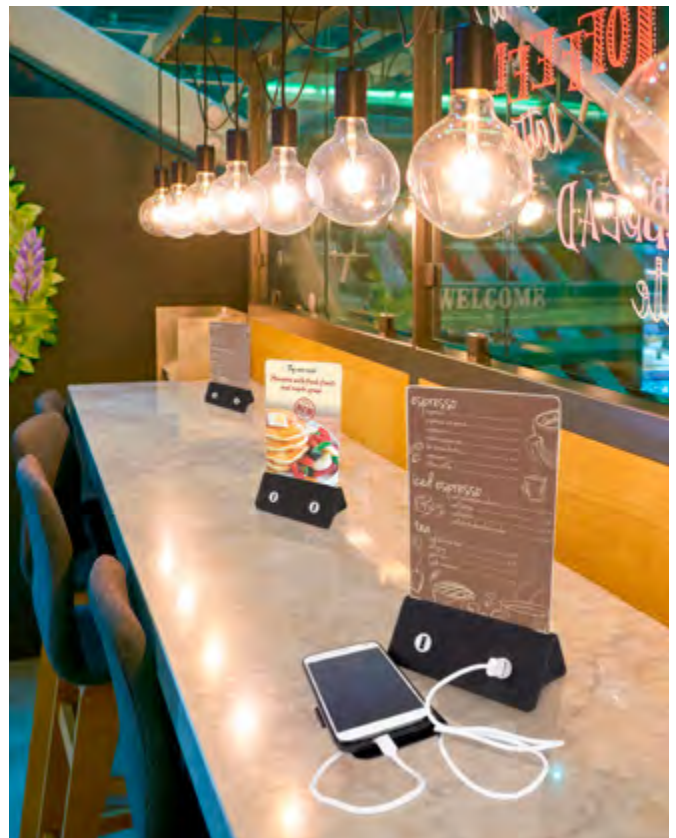

DIVIDER DETAILS



DIMENSIONS

*mm

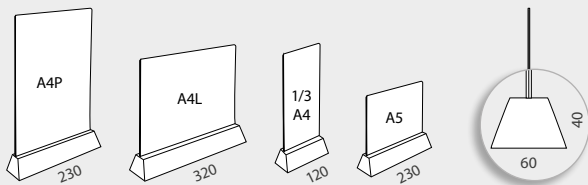

INFORMATION

This Card Holder features a colored plastic base (3 colors available) with a transparent document holder available in 4 sizes. Ideal as marketing tool for a whole range of businesses such as restaurants, hotels, receptions, waiting rooms or supermarket as checkout divider. Graphic sheet not included.

A5 HOLDER	COLOR	SIZE	
50.134		A5 210x148mm	x10
1/3 A4 HOLDER	COLOR	SIZE	
50.437		1/3 A4 100x210mm	x10
A4 HOLDER	COLOR	SIZE	
50.439		A4 landscape 297x210mm	x10
50.435		A4 portrait 210x297mm	x10

DIVIDER DETAILS

*mm

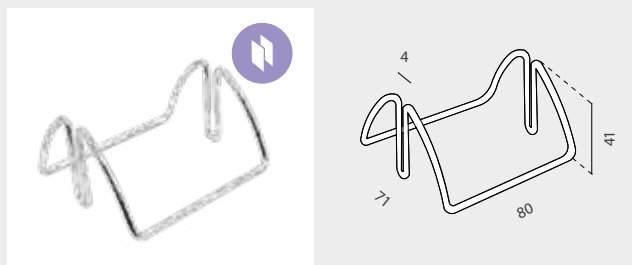

INFORMATION

This stylish open base is made of 3mm chromed wire. Suitable for different acrylic support sizes with a maximum thickness of 4mm for double sided use. Ideal as desktop marketing tool for a whole range of businesses. Acrylic holder not included.

C.WIRE BASE	QTY	N.W	G.W	C.B.M	SIZE
Packing	1	0.32kg	0.43kg	0.0041	205x125x160 mm
13.574		Size: 80x41x71mm			x12

BASE DIVIDER



CHROME WIRE BASE FOR SIGN HOLDERS



* the graphic customization and acrylic (13.574) at this page are available but not included

HOLDER DETAILS

*mm



acrylic

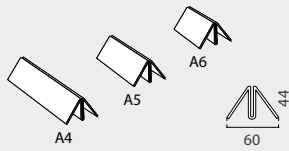

INFORMATION

This open Card Base has an "M" shape and 3 sizes. Suitable to hold portrait or landscape orientation documents. Paper slips in easily through the top and sides.

"M"	SIZE	THICKNESS			
13.035	210mm/A4	2mm	x10 	 	
13.036	148mm/A5	2mm	x10 	 	
13.037	105mm/A6	2mm	x10 	 	

"M" ACRYLIC HOLDER



HOLDER DETAILS

*mm



acrylic

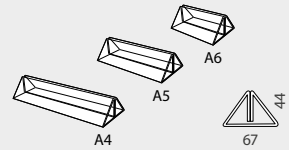

INFORMATION

This open Base has a "Volcano" shape and 3 sizes. Suitable to hold portrait or landscape orientation documents. Paper slips in easily through the top and sides.

"A"	SIZE	THICKNESS			
13.394	210mm/A4	2mm	x10 	 	
13.395	148mm/A5	2mm	x10 	 	
13.396	105mm/A6	2mm	x10 	 	

"A" ACRYLIC HOLDER



HOLDER DETAILS

*mm

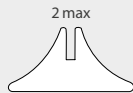

INFORMATION

This Luxe base made of injected Polystyrene holds A5 portrait sheets. It also allows other sizes in portrait or landscape orientation for 2mm maximum thickness. Paper slips in easily through the top.

LUXE	SIZE	THICKNESS			
13.034	148mm/A5	2mm	x10 	 	

LUXE BASE HOLDER



HOLDER DETAILS

*mm

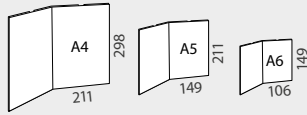

INFORMATION

This sign holder features a double-portrait shape with double-sided viewing and 3 available sizes. Paper slips through the top and sides.

DUO	SIZE	THICKNESS			
13.283	A4x2	2mm	x5		
13.402	A5x2	2mm	x5		
13.403	A6x2	2mm	x5		

DUO ACRYLIC HOLDER



HOLDER DETAILS

*mm

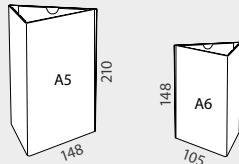

INFORMATION

This sign holder display features a triangular prism shape with triple-sided viewing and 2 available sizes. Paper slips through the top.

TRIANGLE	SIZE	THICKNESS			
13.386	A5x3	2mm	x4		
13.387	A6x3	2mm	x4		

TRIANGLE ACRYLIC HOLDER



HOLDER DETAILS

*mm

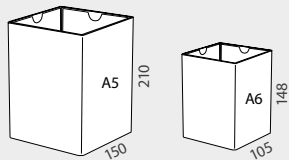

INFORMATION

This sign holder features a square prism shape with quadruple-sided viewing and 2 available sizes. Paper slips through the top.

SQUARE	SIZE	THICKNESS			
13.388	A5x4	2mm	x4		
13.389	A6x4	2mm	x4		

SQUARE ACRYLIC HOLDER



HOLDER DETAILS



INFORMATION

* mm

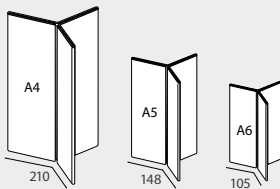

This Sign Holder features a "Y" shape. Available in 3 sizes with portrait orientation. This Sign Holder display is designed for triple-sided viewing. Paper slips through the top. Ideal for restaurants or coffee centers as a menu holder.

"Y"	SIZE	THICKNESS			
13.014	A4x3	2mm	x6		
13.015	A5x3	2mm	x6		
13.390	A6x3	2mm	x6		

"Y" ACRYLIC HOLDER



HOLDER DETAILS



INFORMATION

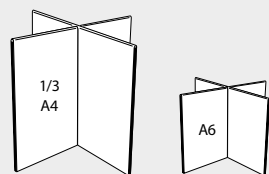

This Sign Holder features a cross shape. 3 sizes available with portrait orientation. This Sign Holder display is designed for quadruple-sided viewing. Paper slips through the top. Ideal for restaurants or coffee centers as a menu holder.

"X"	SIZE	THICKNESS			
13.437	A6	2mm	x5		
13.438	1/3 A4	2mm	x5		

"X" ACRYLIC HOLDER



HOLDER DETAILS



INFORMATION

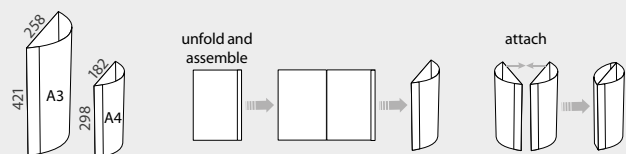

CURVED	SIZE	THICKNESS			
13.420	A3	0.4mm	x10		
13.421	A4	0.4mm	x10		

CURVED PVC DISPLAY



HOLDER DETAILS



INFORMATION

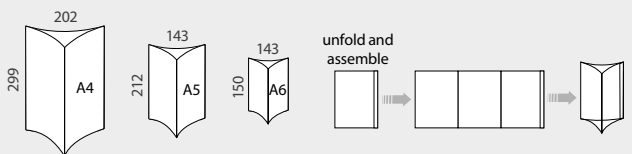

TRIANGLE	SIZE	THICKNESS			
13.422	A4x3	0.4mm	x10		
13.423	A5x3	0.4mm	x10		
13.424	A6x3	0.4mm	x10		

TRIANGLE PVC DISPLAY



HOLDER DETAILS



INFORMATION

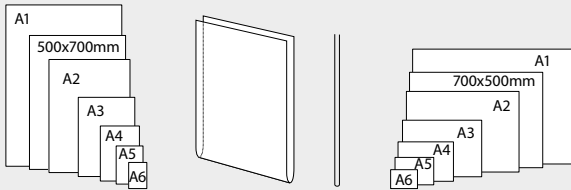

This sign pocket made of acrylic featuring landscape or portrait orientation and 7 available sizes. Suitable for wall mounting or hanging from ceiling for double-sided viewing. Paper slips in easily through the top and sides. Product supplied without holes.

SANDWICH	PORTRAIT	THICKNESS			
13.020P	A1	2mm	x5		
13.021P	A2	2mm	x5		
13.022P	A3	2mm	x5		
13.023P	A4	2mm	x10		
13.024P	A5	2mm	x10		
13.025P	A6	2mm	x10		
13.026P	500x700mm	2mm	x5		

SANDWICH	LANDSCAPE	THICKNESS			
13.020L	A1	2mm	x5		
13.021L	A2	2mm	x5		
13.022L	A3	2mm	x5		
13.023L	A4	2mm	x10		
13.024L	A5	2mm	x10		
13.025L	A6	2mm	x10		
13.026L	500x700mm	2mm	x5		

ACRYLIC POCKET



INFORMATION

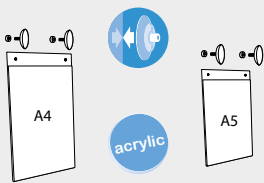

This acrylic Sign Pocket is made of acrylic and it is suitable for fixing on glass or flat surfaces thanks to its suction cups, which are included. Featuring portrait orientation with 2 sizes available. This "Sandwich" Sign Holder is designed for double-sided viewing. Paper slips in easily through the top and sides.

S.C. SANDWICH	SIZE	THICKNESS			
13.376	A4	2mm	x5		
13.397	A5	2mm	x5		

ACRYLIC POCKET WITH SUCTION CUPS



HOLDER DETAILS



DIMENSIONS



INFORMATION

This sign wall Pocket is made of acrylic. Featuring portrait or landscape orientation with 3 available sizes (A3, A4 and A5 format). This "Sandwich" Pocket has 2 holes at the top for hanging from ceiling or wall mounting. The paper slips in easily through the sides of the pocket.

W.SANDWICH	PORTRAIT	THICKNESS				
13.371P	A3	2mm	x5			
13.372P	A4	2mm	x5			
13.373P	A5	2mm	x5			
W.SANDWICH	LANDSCAPE	THICKNESS				
13.371L	A3	2mm	x5			
13.372L	A4	2mm	x5			
13.373L	A5	2mm	x5			

ACRYLIC WALL POCKET



HOLDER DETAILS

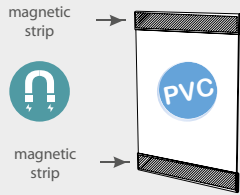

INFORMATION

This open display features a portrait shape and 7 sizes for documents. Includes 2 magnetic strips at the back side for fixing on metallic surfaces. Paper slips in easily through the sides.

SANDWICH	PORTRAIT	THICKNESS				
13.425	A1	0.5mm	x10			
13.426	A2	0.5mm	x10			
13.052	A3	0.5mm	x10			
13.053	A4	0.5mm	x10			
13.054	A5	0.5mm	x20			
13.055	A6	0.5mm	x20			
13.427	A7	0.5mm	x30			

MAGNETIC PVC POCKET



HOLDER DETAILS

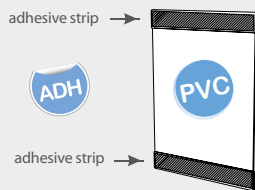

INFORMATION

This open display features a portrait shape and 7 sizes for documents. Includes 2 adhesive strips at the back side for fixing on different surfaces. Paper slips in easily through the sides.

SANDWICH	PORTRAIT	THICKNESS				
13.428	A1	0.5mm	x10			
13.429	A2	0.5mm	x10			
13.064	A3	0.5mm	x10			
13.065	A4	0.5mm	x10			
13.066	A5	0.5mm	x20			
13.067	A6	0.5mm	x20			
13.430	A7	0.5mm	x30			

ADHESIVE PVC POCKET



SMALL TRIARAMA MOBILE KIT

TRIARAMA DETAIL

INFORMATION *mm

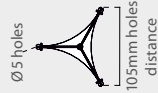
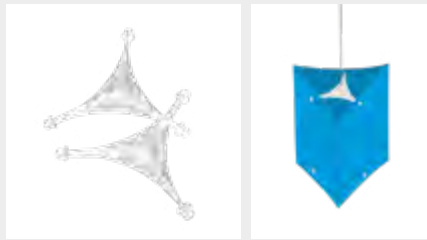

This 3-sided mobile kit has a Graphic size from A4 size up 400mm (200mm minimum size).

SMALL TRIARAMA

12.067

x2

MEDIUM TRIARAMA MOBILE KIT

TRIARAMA DETAIL

INFORMATION *mm

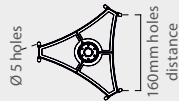
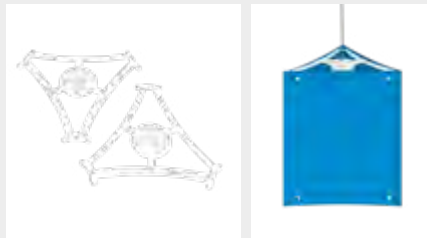

This 3-sided mobile kit has a Graphic size from A4 size up 400mm (200mm minimum size).

MEDIUM TRIARAMA

12.235

x2

BIG TRIARAMA MOBILE KIT

TRIARAMA DETAIL

INFORMATION *mm

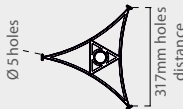
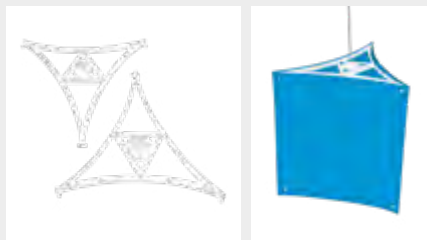

This 3-sided mobile kit has a Graphic size from 400mm up to 750mm (330mm minimum size).

BIG TRIARAMA

12.234

x2

CUADRAMA MOBILE KIT

QUADRAMA DETAIL

INFORMATION *mm

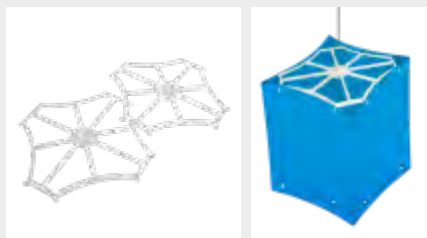

This 4-sided mobile kit has a Graphic size from A4 size up 400mm (200mm minimum size).

QUADRAMA

12.236

x2



* the graphics at this page are available but not included

PROFILE DETAILS



INFORMATION

CheapClip Kit includes 1 profile and 2 hangers. There are 3 profile lengths and 3 colors to choose from. Its snap-on locking system ensures a firm grip. Ideal for suspending posters to the ceiling or wall.

*mm



CHEAP 500	QTY	N.W	G.W	C.B.M	SIZE
Packing	12	0.16kg	0.36kg	0.014	360x80x520mm
10.621	<input type="checkbox"/>	Length: 500mm		x12	
10.622	<input type="checkbox"/>				
10.623	<input type="checkbox"/>				
CHEAP 800	QTY	N.W	G.W	C.B.M	SIZE
Packing	12	0.28kg	0.48kg	0.023	360x80x820mm
10.624	<input type="checkbox"/>	Length: 800mm		x12	
10.625	<input type="checkbox"/>				
10.626	<input type="checkbox"/>				
CHEAP 1000	QTY	N.W	G.W	C.B.M	SIZE
Packing	12	0.36kg	0.56kg	0.029	360x80x1020mm
10.627	<input type="checkbox"/>	Length: 1000mm		x12	
10.628	<input type="checkbox"/>				
10.629	<input type="checkbox"/>				

CHEAPCLIP



PROFILE DETAILS



INFORMATION

SoftClip Kit includes 1 profile and 2 hangers. There are 3 profile lengths and 3 colors to choose from. Its snap-on locking system ensures a firm grip. Ideal for suspending posters to the ceiling or wall.

*mm



SOFT 500	QTY	N.W	G.W	C.B.M	SIZE
Packing	12	0.28kg	0.4kg	0.014	360x80x520mm
10.612	<input type="checkbox"/>	500mm		x12	
10.613	<input type="checkbox"/>				
10.614	<input type="checkbox"/>				
SOFT 800	QTY	N.W	G.W	C.B.M	SIZE
Packing	12	0.52kg	0.72kg	0.023	360x80x820mm
10.615	<input type="checkbox"/>	800mm		x12	
10.616	<input type="checkbox"/>				
10.617	<input type="checkbox"/>				
SOFT 1000	QTY	N.W	G.W	C.B.M	SIZE
Packing	12	0.72kg	0.91kg	0.029	360x80x1020mm
10.618	<input type="checkbox"/>	1000mm		x12	
10.619	<input type="checkbox"/>				
10.620	<input type="checkbox"/>				

SOFTCLIP



PROFILE DETAILS

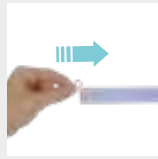



INFORMATION

*mm

BestClip Kit includes 1 profile and 2 hangers. There are 3 profile lengths and 3 colors to choose from. Its snap-on locking system ensures a firm grip. Ideal for suspending posters to the ceiling or wall.



BEST 500	QTY	N.W	G.W	C.B.M	SIZE
Packing	12	0.4kg	0.6kg	0.014	360x80x520mm
10.603	<input type="checkbox"/>	500mm			x12 
10.604	<input type="checkbox"/>				
10.605	<input checked="" type="checkbox"/>				
BEST 800	QTY	N.W	G.W	C.B.M	SIZE
Packing	12	0.64kg	0.84kg	0.023	360x80x820mm
10.606	<input type="checkbox"/>	800mm			x12 
10.607	<input type="checkbox"/>				
10.608	<input checked="" type="checkbox"/>				
BEST 1000	QTY	N.W	G.W	C.B.M	SIZE
Packing	12	0.72kg	0.92kg	0.029	360x80x1020mm
10.609	<input type="checkbox"/>	1000mm			x12 
10.610	<input type="checkbox"/>				
10.611	<input checked="" type="checkbox"/>				

BESTCLIP



PROFILE DETAILS





INFORMATION

*mm

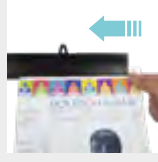
StrongClip Kit includes 1 profile and 2 hangers. There are 3 profile lengths and 3 colors to choose from. Its snap-on locking system ensures a firm grip. Ideal for suspending posters to the ceiling or wall.



STRONG 500	QTY	N.W	G.W	C.B.M	SIZE
Packing	12	0.52kg	0.72kg	0.029	360x160x520mm
10.630	<input type="checkbox"/>	500mm			x12 
10.631	<input type="checkbox"/>				
10.632	<input checked="" type="checkbox"/>				
STRONG 800	QTY	N.W	G.W	C.B.M	SIZE
Packing	12	1kg	1.2kg	0.035	270x160x820mm
10.633	<input type="checkbox"/>	800mm			x12 
10.634	<input type="checkbox"/>				
10.635	<input checked="" type="checkbox"/>				
STRONG 1000	QTY	N.W	G.W	C.B.M	SIZE
Packing	12	1.2kg	1.4kg	0.044	270x160x1020mm
10.636	<input type="checkbox"/>	1000mm			x12 
10.637	<input type="checkbox"/>				
10.638	<input checked="" type="checkbox"/>				

STRONGCLIP



PROFILE DETAILS

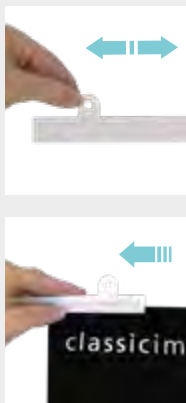

KIT INCLUDES

PROFILE *mm

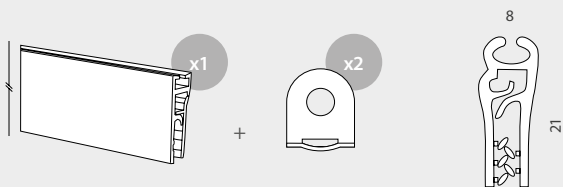

INFORMATION

PlastiClip Kit includes: 2 upper hooks (which are adjustable along the top rail) and 1 poster profile with snap-on locking system which ensures a firm grip. Also, PlastiClip features 5 profile lengths and 2 colors available. Ideal for suspending posters, "banner" promotions, special offers or prices to the ceiling over the products at the supermarkets or malls.

PLASTI 440	QTY	N.W	G.W	C.B.M	SIZE
Packing	12	0.48kg	0.68kg	0.004	130x90x440mm
10.526	<input type="checkbox"/>	440mm		x12	
10.527	<input checked="" type="checkbox"/>				
PLASTI 500	QTY	N.W	G.W	C.B.M	SIZE
Packing	12	0.6kg	0.8kg	0.005	130x90x500mm
10.528	<input type="checkbox"/>	500mm		x12	
10.529	<input checked="" type="checkbox"/>				
PLASTI 600	QTY	N.W	G.W	C.B.M	SIZE
Packing	12	0.72kg	0.92kg	0.007	360x90x600mm
10.530	<input type="checkbox"/>	600mm		x12	
10.531	<input checked="" type="checkbox"/>				
PLASTI 800	QTY	N.W	G.W	C.B.M	SIZE
Packing	12	0.88kg	1.05kg	0.009	130x90x800mm
10.532	<input type="checkbox"/>	800mm		x12	
10.533	<input checked="" type="checkbox"/>				
PLASTI 1000	QTY	N.W	G.W	C.B.M	SIZE
Packing	12	1.08kg	1.2kg	0.01	130x90x1000mm
10.534	<input type="checkbox"/>	1000mm		x12	
10.535	<input checked="" type="checkbox"/>				

PLASTICLIP



PROFILE DETAILS



KIT INCLUDES

PROFILE *mm



INFORMATION

AluGrip Kit features 4 profile lengths and 2 different hangers to choose. Its gripper system ensures a firm grip. Ideal for suspending posters to the ceiling or wall.

ALUGRIP 300	QTY	N.W	G.W	C.B.M	SIZE
Packing	4	0.31kg	0.5kg	0.0008	50x45x340mm
10.172	300mm	2 Grippers (G)	x4		
ALUGRIP 500	QTY	N.W	G.W	C.B.M	SIZE
Packing	4	0.51kg	0.7kg	0.0012	50x45x540mm
10.173	500mm	3 Grippers (G)	x4		
ALUGRIP 700	QTY	N.W	G.W	C.B.M	SIZE
Packing	4	0.7kg	0.85kg	0.0017	50x45x740mm
10.174	700mm	4 Grippers (G)	x4		
ALUGRIP 1000	QTY	N.W	G.W	C.B.M	SIZE
Packing	4	1kg	1.4kg	0.0023	50x45x1040mm
10.175	1000mm	5 Grippers (G)	x4		

GRIPPERS FOR ALUGRIP



Pack of 10 Grippers for fixing graphics inside the AluGrip profile system.

ALU GRIPPERS	QTY	N.W	G.W	C.B.M	SIZE
Packing	10	0.025kg	0.03kg	0.0005	75x75x90mm
10.176	50mm	x10			

ENDCAPS FOR ALUGRIP



Pack of 10 gray plastic Endcaps. It is suitable for completing the AluGrip profile.

ALU ENDCAPS	QTY	N.W	G.W	C.B.M	SIZE
Packing	10	0.007kg	0.008kg	0.0005	75x75x90mm
10.177	x10				

ALUGRIP

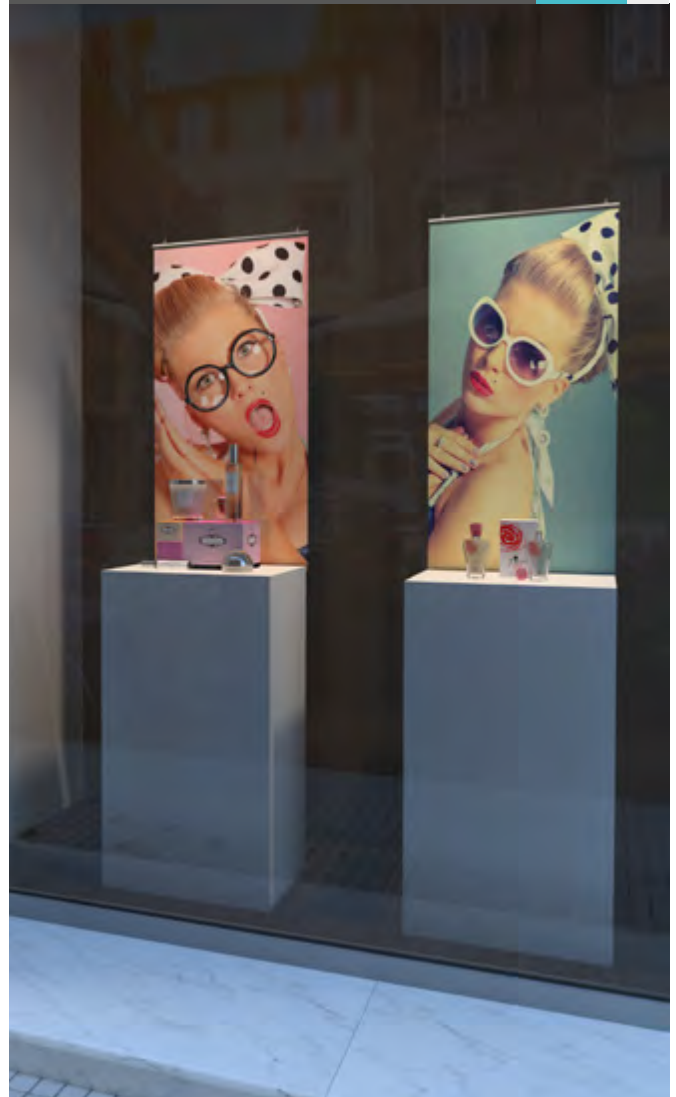

SIDEVIEW HANGERS FOR ALUGRIP

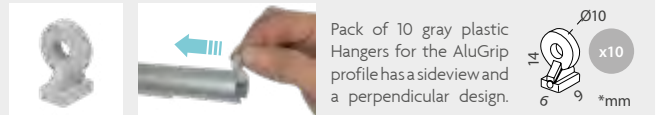

Pack of 10 gray plastic Hangers for the AluGrip profile has a sideview and a perpendicular design.

ALU HANGERS	QTY	N.W	G.W	C.B.M	SIZE
Packing	10	0.005kg	0.005kg	0.0005	75x75x90mm
10.178	x10				

FRONTVIEW HANGERS FOR ALUGRIP

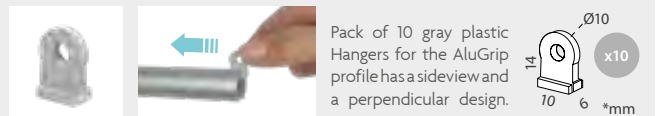

Pack of 10 gray plastic Hangers for the AluGrip profile has a sideview and a perpendicular design.

ALU HANGERS	QTY	N.W	G.W	C.B.M	SIZE
Packing	10	0.006kg	0.01kg	0.00004	65x10x65mm
10.179	x10				

PROFILE DETAILS



KIT INCLUDES

PROFILE *mm



INFORMATION

AluPoster features 6 profile lengths. Its click locking system profile ensures a firm grip for the graphic. Ideal for suspending posters to the ceiling or wall.

ALUPOSTER 300	QTY	N.W	G.W	C.B.M	SIZE
Packing	4	0.4kg	0.6kg	0.0014	80x60x310mm
10.086		300mm		x4	
ALUPOSTER 500	QTY	N.W	G.W	C.B.M	SIZE
Packing	4	0.72kg	0.92kg	0.0024	80x60x510mm
10.087		500mm		x4	
ALUPOSTER 800	QTY	N.W	G.W	C.B.M	SIZE
Packing	4	1.12kg	1.32kg	0.0038	80x60x810mm
10.088		800mm		x4	
ALUPOSTER 1000	QTY	N.W	G.W	C.B.M	SIZE
Packing	4	1.48kg	1.68kg	0.0048	80x60x1010mm
10.089		1000mm		x4	
ALUPOSTER 1200	QTY	N.W	G.W	C.B.M	SIZE
Packing	4	1.68kg	1.88kg	0.0058	80x60x1210mm
10.090		1200mm		x4	
ALUPOSTER 1500	QTY	N.W	G.W	C.B.M	SIZE
Packing	4	2kg	2.2kg	0.0072	80x60x1510mm
10.091		1500mm		x4	

ENDCAPS FOR ALUPOSTER



Pack of 10 grey plastic Endcaps for completing this profile. Ideal for changing the overall look of the Aluposter System.

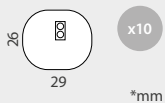

P.ENDCAP	QTY	N.W	G.W	C.B.M	SIZE
Packing	1	0.009kg	0.02kg	0.00004	65x10x65mm
13.399		x10			

ALUPOSTER



RING CLIP FOR ALUPOSTER



Pack of 10 grey plastic Hanger Ring Clips for suspending the AluPoster profile. Ideal for being used with Nylon Roll.

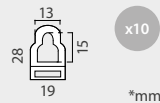

RING CLIP	QTY	N.W	G.W	C.B.M	SIZE
Packing	1	0.047kg	0.01kg	0.00004	65x10x65mm
13.400		x10			

PROFILE DETAILS







KIT INCLUDES

PROFILE *mm



INFORMATION

The AluClip features 6 profile lengths. Its clic locking system ensures a firm grip for the graphic. Ideal for suspending posters to the ceiling or the wall.

ALUCLIP 300	QTY	N.W	G.W	C.B.M	SIZE
Packing	4	0.35kg	0.5kg	0.0009	65x40x320mm
10.080			300mm		x4 
ALUCLIP 500	QTY	N.W	G.W	C.B.M	SIZE
Packing	4	0.57kg	0.8kg	0.0014	65x40x540mm
10.081			500mm		x4 
ALUCLIP 800	QTY	N.W	G.W	C.B.M	SIZE
Packing	4	0.9kg	1.2kg	0.0022	65x40x840mm
10.082			800mm		x4 
ALUCLIP 1000	QTY	N.W	G.W	C.B.M	SIZE
Packing	4	1.2kg	1.5kg	0.0027	65x40x1040mm
10.083			1000mm		x4 
ALUCLIP 1200	QTY	N.W	G.W	C.B.M	SIZE
Packing	4	1.4kg	1.8kg	0.0032	65x40x1240mm
10.084			1200mm		x4 
ALUCLIP 1500	QTY	N.W	G.W	C.B.M	SIZE
Packing	4	1.7kg	2.2kg	0.004	65x40x1540mm
10.085			1500mm		x4 

ENDCAPS FOR ALUCLIP



A Pack of 10 black plastic Endcaps is ideal for completing the AluClip profile.

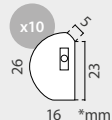

P. ENDCAP	QTY	N.W	G.W	C.B.M	SIZE
Packing	1	0.009kg	0.02kg	0.00004	65x10x65mm
13.398			x10 		

ALUCLIP



RING CLIP FOR ALUCLIP



This Pack of 10 plastic Hanger Ring Clip for suspending the AluClip profile system is ideal for changing the look of the Aluclip Profile System.

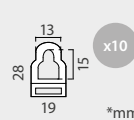

RING CLIP	QTY	N.W	G.W	C.B.M	SIZE
Packing	1	0.047kg	0.01kg	0.00004	65x10x65mm
13.400			x10 		

PROFILE DETAILS



KIT INCLUDES

PROFILE *mm

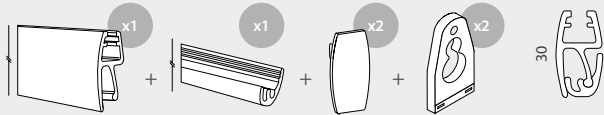

INFORMATION

Alulon features 6 profile lengths. Its snap-on locking system ensures a firm grip for the graphic. Ideal for suspending posters to the ceiling or the wall.

ALULON 500	QTY	N.W	G.W	C.B.M	SIZE
Packing	4	1.2kg	1.4kg	0.0017	540x90x35mm
10.571		500mm		x4	
ALULON 800	QTY	N.W	G.W	C.B.M	SIZE
Packing	4	1.8kg	2.1kg	0.0026	90x35x840mm
10.191		800mm		x4	
ALULON 1000	QTY	N.W	G.W	C.B.M	SIZE
Packing	4	2.2kg	2.6kg	0.0033	90x35x1040mm
10.572		1000mm		x4	
ALULON 1200	QTY	N.W	G.W	C.B.M	SIZE
Packing	4	2.7kg	3kg	0.0039	90x35x1240mm
10.193		1200mm		x4	
ALULON 1500	QTY	N.W	G.W	C.B.M	SIZE
Packing	4	3.4kg	3.8kg	0.0049	90x35x1540mm
10.194		1500mm		x4	
ALULON 3000	QTY	N.W	G.W	C.B.M	SIZE
Packing	4	6.5kg	7.4kg	0.0123	90x45x3025mm
10.195		3000mm		x4	

ENDCAPS FOR ALULON



A Pack of 10 black plastic Endcaps is ideal for completing the Alulon profile.



ENDCAP	QTY	N.W	G.W	C.B.M	SIZE
Packing	1	0.009kg	0.02kg	0.00004	65x10x65mm
10.196		x10			

ALULON

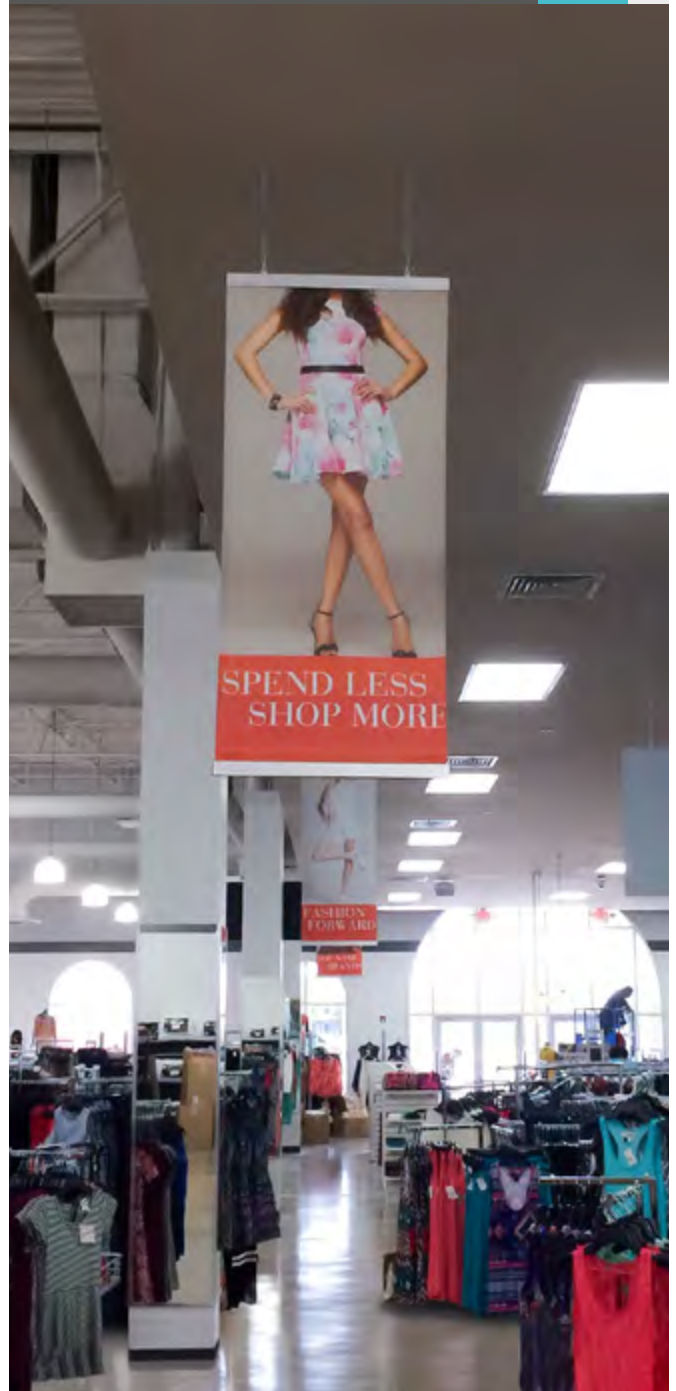

RING CLIP FOR ALULON



A Pack of 10 plastic Hanger Ring Clip. It is ideal for suspending the Alulon System profile.

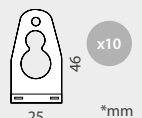

H.RING CLIP	QTY	N.W	G.W	C.B.M	SIZE
Packing	1	0.047kg	0.01kg	0.00004	65x10x65mm
10.197		x10			

PROFILE DETAILS



KIT INCLUDES

PROFILE *mm



INFORMATION

The FastClip System Kit includes: 2 upper grey plastic hangers (which are adjustable along the top rail), 2 grey plastic endcaps and 1 aluminium profile with a pack of retainers which ensures a firm grip for the poster or graphic. Also, FastClip features 6 aluminium profile lengths available. Ideal for suspending posters, "banner" promotions, special offers or prices to the ceiling over the products at retail stores or the supermarkets.

FASTCLIP 300	QTY	N.W	G.W	C.B.M	SIZE
Packing	4	0.65kg	0.8kg	0.0018	340x90x60mm
50.600	300mm	5 Retainers (R)		x4	

FASTCLIP 500	QTY	N.W	G.W	C.B.M	SIZE
Packing	4	1.17kg	1.4kg	0.0029	540x90x60mm
50.601	500mm	9 Retainers (R)		x4	

FASTCLIP 800	QTY	N.W	G.W	C.B.M	SIZE
Packing	4	1.7kg	2kg	0.0045	840x90x60mm
50.602	800mm	15 Retainers (R)		x4	

FASTCLIP 1000	QTY	N.W	G.W	C.B.M	SIZE
Packing	4	2kg	2.45kg	0.0056	90x60x1040mm
50.603	1000mm	19 Retainers (R)		x4	

FASTCLIP 1200	QTY	N.W	G.W	C.B.M	SIZE
Packing	4	2.4kg	2.9kg	0.0067	90x60x1240mm
50.604	1200mm	24 Retainers (R)		x4	

FASTCLIP 1500	QTY	N.W	G.W	C.B.M	SIZE
Packing	4	2.9kg	3.5kg	0.0083	90x60x1540mm
50.605	1500mm	30 Retainers (R)		x4	

FASTCLIP

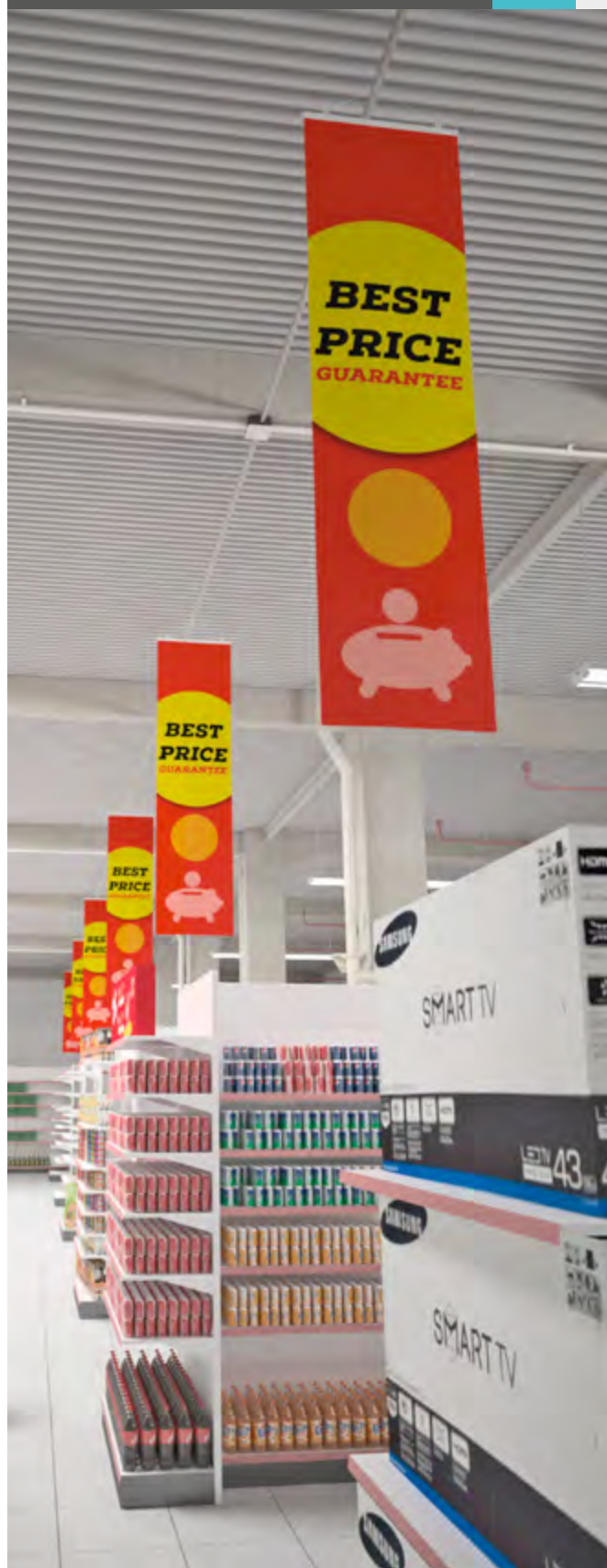

PROFILE DETAILS



KIT INCLUDES

PROFILE *mm





INFORMATION

The Semi Circular FastClip Kit includes: 2 upper hooks (which are adjustable along the top rail), 2 plastic endcaps, 1 poster profile with an adhesive strip on their back face and a pack of retainers which ensures a firm grip. Also, Semi Circular FastClip features 6 profile lengths available. Ideal for suspending posters, "banner" promotions, special offers or prices to the ceiling over the products at the supermarkets or retails stores.

SEMI C.F.300	QTY	N.W	G.W	C.B.M	SIZE
Packing	4	0.45kg	0.6kg	0.0015	340x100x45mm
50.606	300mm		5 Retainers (R)	x4	

SEMI C.F.500	QTY	N.W	G.W	C.B.M	SIZE
Packing	4	0.7kg	1kg	0.0024	100x45x540mm
50.607	500mm		9 Retainers (R)	x4	

SEMI C.F.800	QTY	N.W	G.W	C.B.M	SIZE
Packing	4	1kg	1.4kg	0.0038	100x45x840mm
50.608	800mm		15 Retainers (R)	x4	

SEMI C.F.1000	QTY	N.W	G.W	C.B.M	SIZE
Packing	4	1.3kg	1.8kg	0.0047	100x45x1040mm
50.609	1000mm		19 Retainers (R)	x4	

SEMI C.F.1200	QTY	N.W	G.W	C.B.M	SIZE
Packing	4	1.5kg	2.1kg	0.0056	100x45x1250mm
50.610	1200mm		24 Retainers (R)	x4	

SEMI C.F.1500	QTY	N.W	G.W	C.B.M	SIZE
Packing	4	1.95kg	2.5kg	0.0069	100x45x1540mm
50.611	1500mm		30 Retainers (R)	x4	

SEMI CIRCULAR FASTCLIP



POSTER SYSTEM Decorail

The Decorail is a profile system composed by an aluminium profile in which they can anchor **multiple advertising systems**. Ideal for **islands** and **supermarket modules**.

DECORAIL

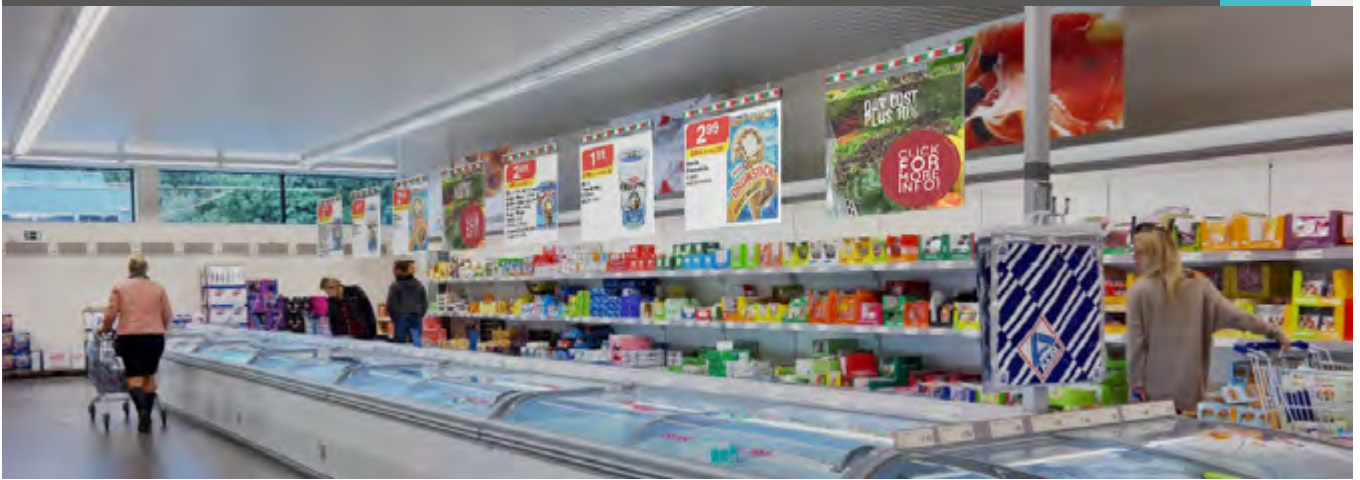

ALUMINIUM PROFILE FOR DECORAIL

PROFILE DETAILS



INFORMATION

*mm

The Decorail 47 mm high aluminium profile offers the optional opportunity to customize the inside front with a graphic. Ideal for promoting offers, products as priceholders, suspending signage over products, increasing their visibility in supermarket sections.



PROFILE	QTY	N.W	G.W	C.B.M	SIZE
Packing	4	6.5kg	7.4kg	0.0123	90x45x3025mm
50.620	3000mm		x4 		

ENDCAP FOR DECORAIL

ENDCAP DETAILS



INFORMATION

*mm

This pack of 10 Endcaps is made of plastic with a grey finish. They avoid the extraction of the profile graphic. With a simple insertion, they are ideal for completing the Decorail Profile Kit.

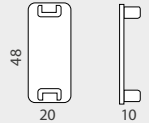

ENDCAP	QTY	N.W	G.W	C.B.M	SIZE
Packing	1	0.009kg	0.02kg	0.0004	65x10x65mm
50.622			x10 		

HANGER RING CLIP FOR DECORAIL

HANGER DETAILS

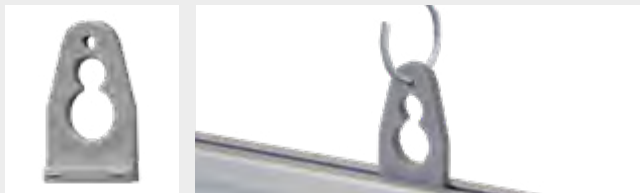

INFORMATION

*mm

This pack of 10 Hangers are made of plastic with a grey finish. They allow the hanging and side shift of the profile. Featuring 3 different diameters for suspending. With a simple insertion, they are ideal for completing the Decorail Profile.

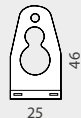

HANGER RING	QTY	N.W	G.W	C.B.M	SIZE
Packing	10	0.047kg	0.01kg	0.00004	65x10x65mm
10.197			x10 		

CLIP HANGER FOR DECORAIL

CLIP DETAILS



INFORMATION

*mm

This pack of 10 Clips Hangers is made of plastic. They allow the suspension and side shift of signage and promotional posters. With a simple side insertion, they are ideal for completing the Decorail Profile Kit.

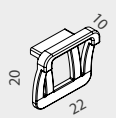

HANGER CLIP	QTY	N.W	G.W	C.B.M	SIZE
Packing	1	0.009kg	0.02kg	0.0004	65x10x65mm
50.623			x10 		

SIGN SYSTEM CONTENT

EN	Standard signage system for indoor use. Straight aluminium profile. Recommended materials: digital printing and vinyl cutting. Supplied in complete kits. Graphic and screws not included.
FR	Système de signalisation composé d'un profil en aluminium droit. Matières recommandées: papier photographique, vinyle de coupe, etc. Vendus en jeux complets. Visuel et vis non incluses.
PT	Sinalização de interior com perfil recto. Materiais recomendados: Papel fotográfico, vinil de recorte, etc. Kit completo. Impressão e parafusos de fixação não incluídos.
ES	Sistema de señalización estándar para uso interior. Perfilera de aluminio recta. Materiales recomendados: impresión digital y vinilo de corte. Kits completos. Gráfica y tornillería no incluidas.

SIGN SYSTEM DETAILS



two straight profiles



INFORMATION

PROFILE SIZE

*mm

- Straight profile
- Plastic pieces for fixing
- Aluminium plate
- Plastic endcaps

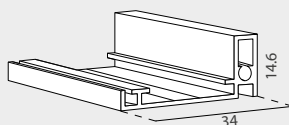

“BARGELLO” STRAIGHT



INSTALLING EXPLANATION

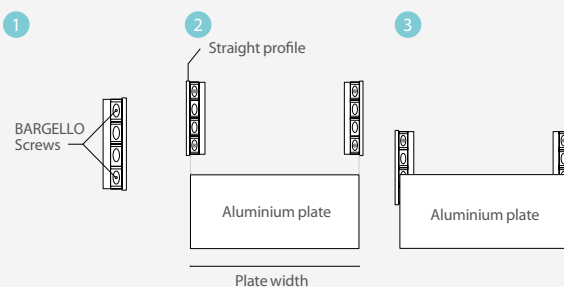

Possibility of fixing with double sided tape. Continue with the next steps if you wish to screw it to the wall:

1. Make two holes in the side profiles, as shown.
2. Screw the profiles to the wall, adjusting the width of the plate.
3. Fix the central plate by pressing on the side covers.

BARGELLO	SIZE	
15.634	120x60mm	
15.635	220x60mm	
15.636	300x60mm	
15.637	150x90mm	
15.638	220x90mm	
15.639	300x90mm	
15.668	124x120mm	
15.640	150x124mm	
15.641	220x124mm	
15.642	300x124mm	

BARGELLO	SIZE	
15.670	150x150mm	
15.643	220x150mm	
15.644	300x150mm	
15.645	400x150mm	
15.672	180x180mm	
15.646	500x60mm	
15.647	500x90mm	
15.648	500x124mm	
15.649	500x150mm	
15.650	500x180mm	

* Custom printing in full color is available but not included with the price, please request us.

SIGN SYSTEM CONTENT

EN	Standard signage system for indoor use. Curved aluminium profile. Recommended materials: digital printing and vinyl cutting. Supplied in complete kits. Graphic and screws not included.
FR	Système de signalisation composé d'un profil en aluminium courbé. Matières recommandées: papier photographique, vinyle de coupe, etc. Vendus en jeux complets. Visuel et vis non incluses.
PT	Sinalização de interior com perfil curvo. Materiais recomendados: Papel fotográfico, vinil de recorte, etc. Kit completo. Impressão e parafusos de fixação não incluídos.
ES	Sistema de señalización estándar para uso interior. Perfilera de aluminio curva. Materiales recomendados: impresión digital y vinilo de corte. Kits completos. Gráfica y tornillería no incluidas.

SIGN SYSTEM DETAILS



INFORMATION

PROFILE SIZE

*mm

- Curved profile
- Plastic pieces for fixing
- Aluminium plate
- Plastic endcaps

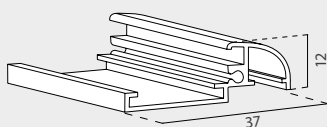

“ORSAY” CURVED

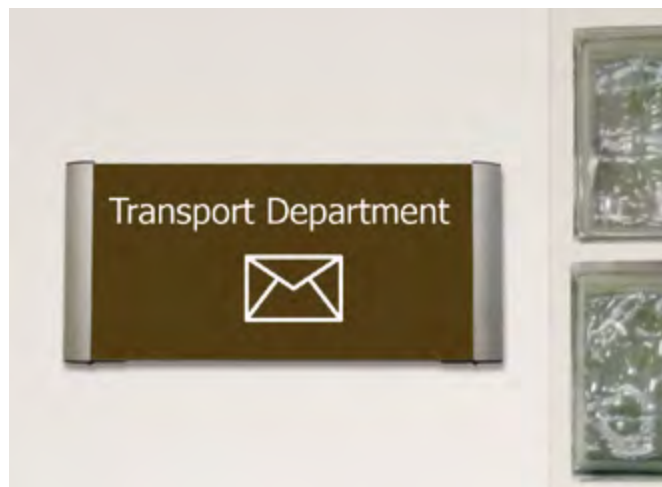

INSTALLING EXPLANATION

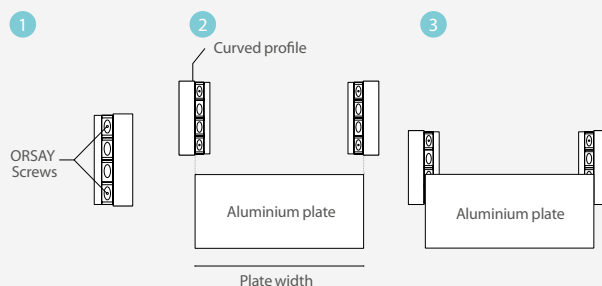

Possibility of fixing with double sided tape. Continue with the next steps if you wish to screw it to the wall:

1. Make two holes in the side profiles, as shown.
2. Screw the profiles to the wall, adjusting the width of the plate.
3. Fix the central plate by pressing on the side covers.

ORSAY	SIZE
15.651	120x60mm
15.652	220x60mm
15.653	300x60mm
15.654	150x90mm
15.655	220x90mm
15.656	300x90mm
15.657	150x124mm
15.658	220x124mm
15.659	300x124mm

ORSAY	SIZE
15.660	220x150mm
15.661	300x150mm
15.662	400x150mm
15.663	500x60mm
15.664	500x90mm
15.665	500x124mm
15.666	500x150mm
15.667	500x180mm

* Custom printing in full color is available but not included with the price, please request us.

SIGN SYSTEM CONTENT

EN	Signaling system composed by curved aluminum plates and side covers. Available in 3 different widths. This system allows the composition of curved wall directories according to customer needs. The components of this system are supplied separately.
FR	Système de signalisation avec profil d'aluminium courbé et bouchons latéraux. Disponible en 3 hauteurs différentes. Ce système permet la création de panneaux directionnels en fonction des besoins de clients. Les éléments de ce système sont vendus séparément.
PT	Perfil curvo de alumínio com tampas laterais para a criação de placas de sinalização. Está disponível em 3 alturas diferentes. Este sistema permite a construção de placas de sinalização mediante as necessidades do cliente. Os componentes deste sistema são vendidos por separado.
ES	Sistema de señalización compuesto por placas de aluminio curvas y tapas laterales. Disponible en 3 anchos distintos. Este sistema permite la composición de directorios de pared curvos según la necesidad del cliente. Los componentes de este sistema se suministran por separado.



“BEYELER” CURVED

Includes plastic protector



EXTERNAL SIZES

*mm



PROFILE (PRICE FOR LINEAR METER)

HEIGHT

10.224	60mm	
10.225	90mm	
10.226	140mm	













PROFILE CUT

10.233	Unit cutting	
--------	--------------	--

PLASTIC ENDCAPS

COLOR

HEIGHT

10.227		60mm	x10 
10.230		60mm	x10 
10.228		90mm	x10 
10.231		90mm	x10 
10.229		140mm	x10 
10.232		140mm	x10 

* Custom printing in full color is available but not included with the price, please request us.

SIDES DETAILS



DIMENSIONS

*mm

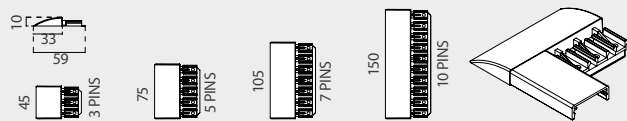

REF.	COLOR	PINS	LENGTH	UNIT PACK
15.310		3 Pins	45mm	x10
15.311		5 Pins	75mm	x10
15.312		7 Pins	105mm	x10
15.313		10 Pins	150mm	x10

DATA FRAME DETAILS



DIMENSIONS

*mm

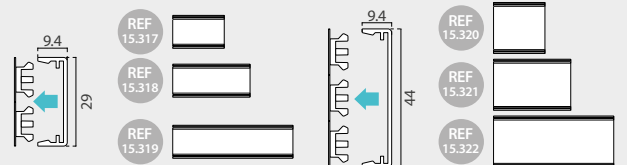

REF.	COLOR	PINS	HEIGHT	WIDTH	UNIT PACK
15.317		2 Pins	29mm	600mm	x4
15.318		2 Pins	29mm	900mm	x4
15.319		2 Pins	29mm	1400mm	x4
15.320		3 Pins	44mm	600mm	x4
15.321		3 Pins	44mm	900mm	x4
15.322		3 Pins	44mm	1400mm	x4

RIGID HOLDERS DETAILS



SET-UP | DIMENSIONS

*mm

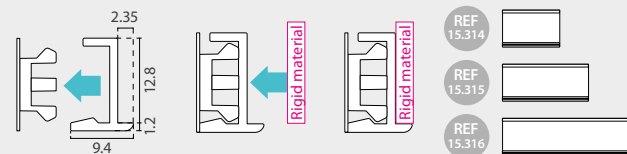

REF.	COLOR	PINS	MAX. THICK	HEIGHT	WIDTH	UNIT PACK
15.314		1 Pin	± 2.35mm	14mm	600mm	x4
15.315		1 Pin	± 2.35mm	14mm	900mm	x4
15.316		1 Pin	± 2.35mm	14mm	1400mm	x4

“VICENZA” SIGN SYSTEM



INFORMATION

The "Vicenza" wall signaling system is composed of multi-pin side connectors, directory profiles, rigid panel holders and profiles for inserting data sheets. Vinceza is ideal for being used as a directory for classrooms, hotels, hospitals, libraries, offices, banks or travel agencies.

INSERT HOLDER DETAILS



DIMENSIONS

*mm

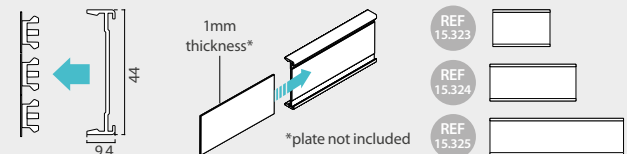

REF.	COLOR	PINS	THICK	HEIGHT	WIDTH	UNIT PACK
15.323		3 Pins	± 1mm	44mm	600mm	x4
15.324		3 Pins	± 1mm	44mm	900mm	x4
15.325		3 Pins	± 1mm	44mm	1400mm	x4

* Custom printing in full color is available but not included with the price, please request us.

SIGN DETAILS



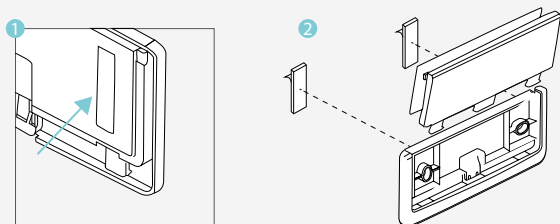

INSTALLING EXPLANATION - FOAM ADHESIVE STRIP



INFORMATION

This Wall signage system is composed of folding plastic pockets with transparent front for a quick and easy graphic exchange. 3 sizes available.

DATA	SHAPE	SIZE
15.200		149x63mm
15.201		149x104mm
15.202		149x145mm

DATA POCKET

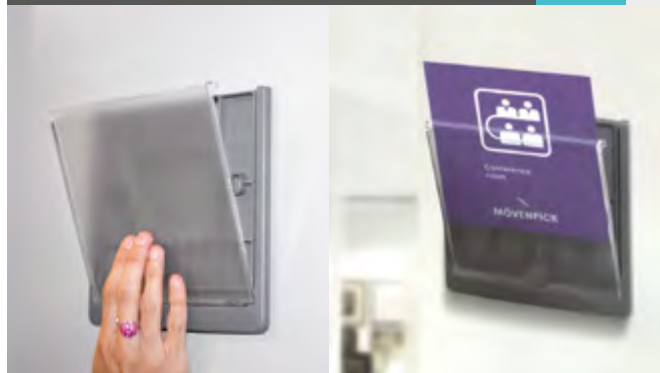

INSTALLING EXPLANATION - SCREWS

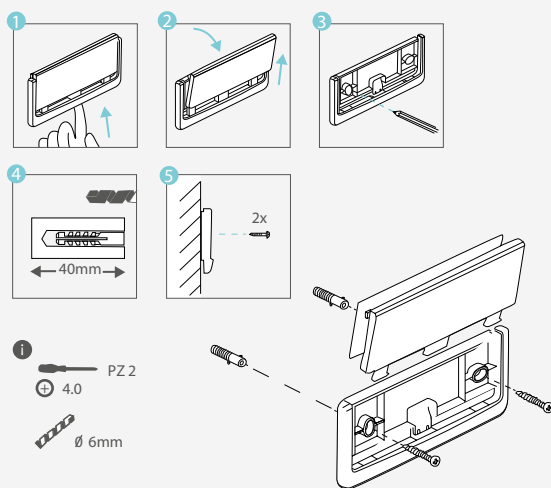

SIGN DETAILS



DIMENSIONS

*mm

The Data Frame includes an acrylic frame, available in 2 sizes (squared and rectangle) and 2 adhesives included for fixing easily the sign.

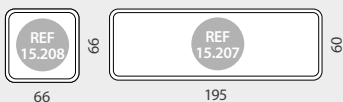

DATA	SIZE
15.207	195x60mm
15.208	66x66mm

ACRYLIC DATA FRAME



* Custom printing in full color is available but not included with the price, please request us.

SIGN DETAILS

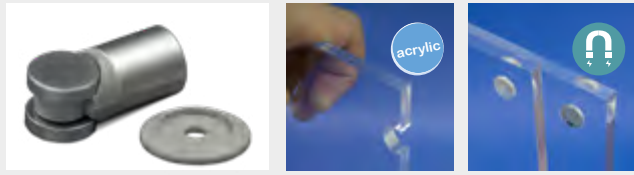

DIMENSIONS

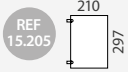
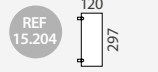
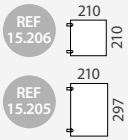
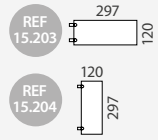

SETTING-UP

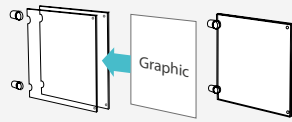

INFORMATION

This double-sided flag sign system for fixing on the wall allows an easy change of graphic thanks its magnetic closing acrylic sheets. The set includes: 2 acrylic sheets (3mm thickness) and 2 mounting silver standoffs pieces.

REF.	SHAPE	THICKNESS	SIZE
15.203		3mm	297x120mm
15.204		3mm	120x297mm
15.205		3mm	210x297mm
15.206		3mm	210x210mm

ACRYLIC FLAG



SIGN DETAILS

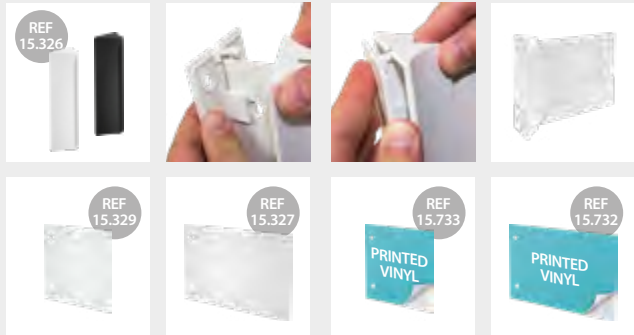

DIMENSIONS

*mm

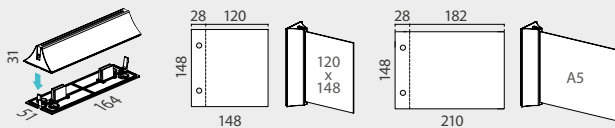

INFORMATION

You can choose between white or black wall support, 2 sizes of signs and with the printing included or without it. The recommended materials for printing are digital and vinyl cutting. The screws are not included.

REF.	COLOR	SIZE	UNIT PACK
15.326		164x51x31mm	x5

REF.	2- SIDED PRINTING	THICK	GRAPHIC SIZE	UNIT PACK
15.327	NO PRINTING	2mm	A5 (x2)	x5
15.329	NO PRINTING	2mm	148x148mm (x2)	x5

HALLWAY FLAG

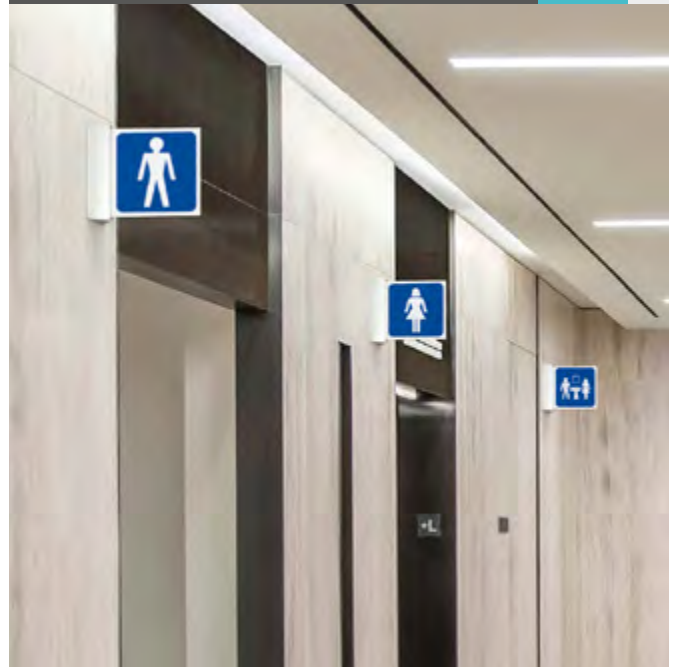

MORE SIGNS UNDER REQUEST: CASHDISPLAY.COM | EBERSIGN.COM



+ SIGNS AVAILABLE

REF.	2- SIDED PRINTING	THICK	GRAPHIC SIZE	UNIT PACK
15.732	PRINTING INCLUDED	2mm	A5 (x2)	x5
15.733	PRINTING INCLUDED	2mm	120x148mm (x2)	x5

SIGN DETAILS



SETTING-UP EXPLANATION

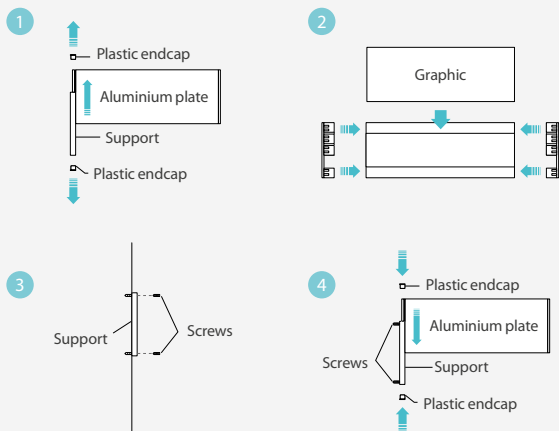

1. Remove the plastic endcaps and the plate from the wall support.
2. Remove the plastic endcaps and place the graphic inside the plate.
3. Screw the aluminium support direct to the wall, as indicated.
4. Reattach the aluminium plate and plastic endcaps inside the plate.

INFORMATION

The Straight Flag Kit contents: double-sided aluminium plates, wall fixing support and plastic endcaps, printing and screws are not included. This system is ideal for being used as signage in all types of corridors such as classrooms, hotels, hospitals, libraries, offices, banks or travel agencies.

REF.	SIZE
15.685	220x90mm
15.686	320x90mm
15.687	220x124mm
15.688	320x124mm
15.689	420x124mm
15.690	150x150mm
15.691	220x150mm
15.692	320x150mm
15.693	420x150mm

* Custom printing is available but not included. The mounting screws are not included.

STRAIGHT FLAG







STANDOFF DETAILS

*mm



INFORMATION

Golden or chromed finish. Ideal for creating flag signage or as a shelf stand.

	COLOR	SIZE	MAX. THICKNESS	
15.560		25x25mm	9.5mm	x4 
15.558		35x35mm	12mm	x4 
15.561		25x25mm	9.5mm	x4 
15.559		35x35mm	12mm	x4 

CLAW STANDOFF EDGE PANEL

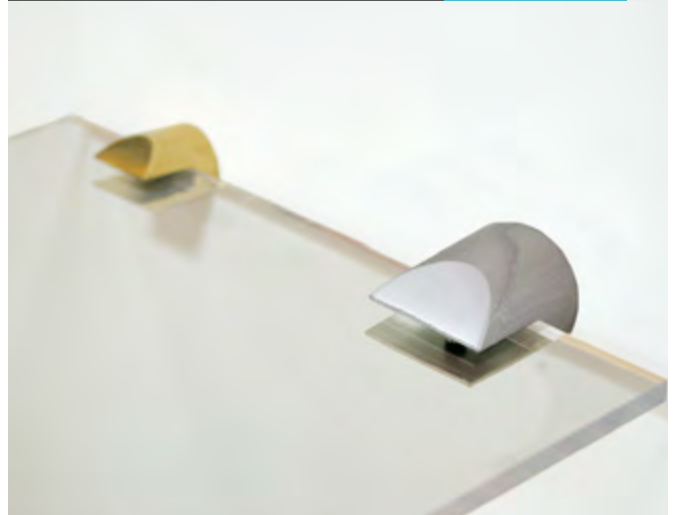

STANDOFF DETAILS

*mm



INFORMATION

Gold or chromed finish. Ideal for creating flag signage or as a shelf stand.

	COLOR	SIZE	MAX. THICKNESS	
15.554		30mm	7.5mm	x2 
15.555		50mm	9.5mm	x2 
15.556		30mm	7.5mm	x2 
15.557		50mm	9.5mm	x2 

HALF DISC STANDOFF EDGE PANEL



STANDOFF DETAILS

*mm



INFORMATION

Gold or chromed finish. Ideal for creating flag signage or as a shelf stand.

	COLOR	SIZE	MAX. THICKNESS	
15.563		50x25mm	10mm	x4 
15.562		80x28mm	12mm	x4 





* Custom printing is available but not included. The mounting screws are not included.

STANDOFF DETAILS

*mm



	COLOR	MAX. THICKNESS	SIZE	
15.565		10mm	25x25mm	x4 
15.564		10mm	25x25mm	x4 







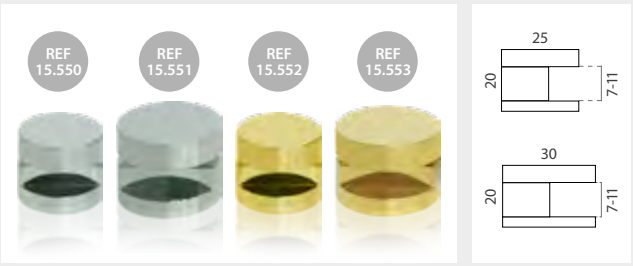

SQUARE STANDOFF EDGE PANEL



STANDOFF DETAILS

*mm



	COLOR	MAX. THICKNESS	SIZE	
15.550		7-11mm	Ø25x20mm	x4 
15.551		7-11mm	Ø30x20mm	x4 
15.552		7-11mm	Ø25x20mm	x4 
15.553		7-11mm	Ø30x20mm	x4 

DISC STANDOFF EDGE PANEL



STANDOFF DETAILS



DIMENSIONS AND SET-UP

*mm

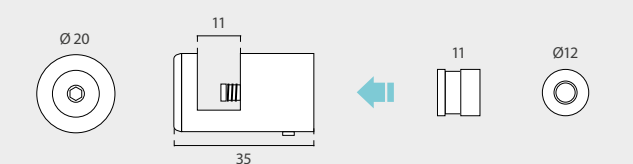

INFORMATION

Signage Mounting is a wall signaling support system which does not need to make holes in the panel. Acrylic support is available but not included.

	MAX. THICKNESS	SIZE	
15.249	11mm	Ø20x35mm	x4 

SATIN STANDOFF EDGE SPACER PANEL

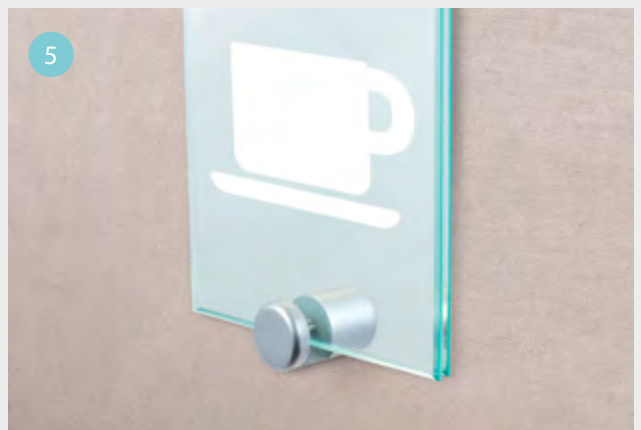

* Custom printing is available but not included. The mounting screws are not included.

SIGN DETAILS



LED

INFORMATION

DIMENSIONS *mm

This signaling system is specially designed to illuminate acrylic or transparent panels with white Led Light. It is supplied in complete kits that includes: Satin aluminium profile holder, white LEDs inside, power supply, plug and wires. The acrylic panel and the mounting screws are not included.

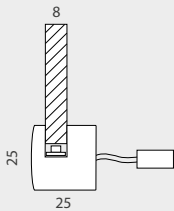

LED SIGN	SIZE	LED
15.725	120mm	9 LEDs
15.726	180mm	12 LEDs
15.727	280mm	21 LEDs

LED SIGN SUPPORT



SIGN DETAILS



LED

INFORMATION

DIMENSIONS *mm

This LED system features a complete kit that includes: 4 satin aluminium standoffs with 6 white LED light bulbs, a power supply with plug and wires. Easy and fast installation. The acrylic panel and the wall mounting screws are not included.

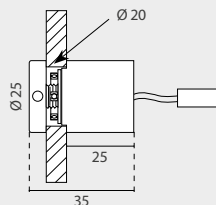

SIZE		
15.724	Ø25x25mm	x4 

LED SIGN SCREW STANDOFF



* Custom printing is available but not included. The mounting screws are not included.



SIGN DETAILS

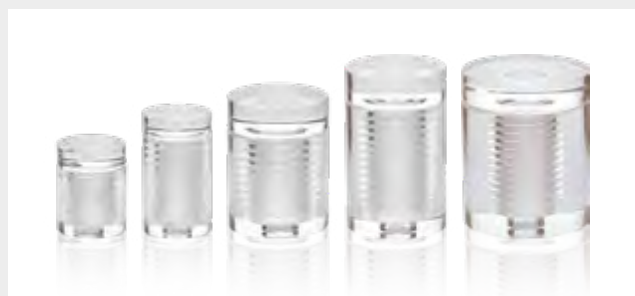

DIMENSIONS

*mm

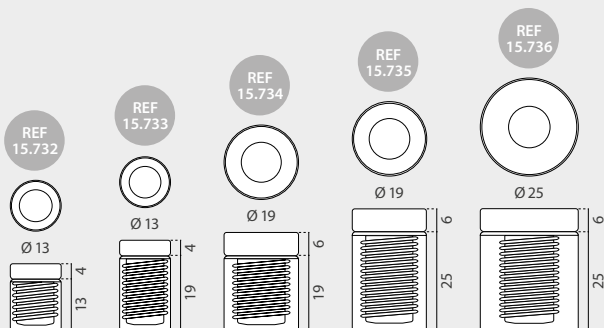

INFORMATION

The transparent stand-offs highlight messages by adding a spacing effect to the wall signs. These stand-offs are made up of two transparent pieces, which allow to separate the sign plate from the wall and at the same time hide the screws to give it a better finish. Ideal for being used as a directory for classrooms, hotels, hospitals, libraries, offices, banks or travel agencies.

TRANSPARENT SCREW STANDOFF



TRANSPARENT SCREW STANDOFF Ø13mm

REF.	SIZE	UNIT PACK
15.732	Ø13x13mm	x4
15.733	Ø13x19mm	x4

TRANSPARENT SCREW STANDOFF Ø19mm

REF.	SIZE	UNIT PACK
15.734	Ø19x19mm	x4
15.735	Ø19x25mm	x4

TRANSPARENT SCREW STANDOFF Ø25mm

REF.	SIZE	UNIT PACK
15.736	Ø25x25mm	x4

* Custom printing is available but not included. The mounting screws are not included.

FIXING STANDOFF Push Standoffs

SIGN DETAILS



EXTERNAL SIZE

*mm

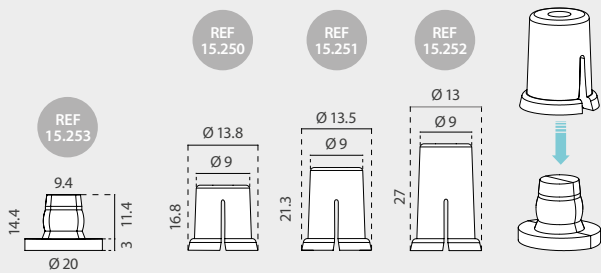



INFORMATION

Stand-offs highlight the messages by adding a spacing effect and allowing a quick graphic change. They are made of white polystyrene and mounting pieces are made of transparent polycarbonate, so it allows a complete integration in the finish. Ideal for generating sign letters or directories for classrooms, hotels, hospitals, offices, banks or for travel agencies.

PLASTIC STANDOFF 16.8mm

15.250		16.8mm	x20 
--------	---	--------	---

PLASTIC STANDOFF 21.3mm

15.251		21.3mm	x20 
--------	---	--------	---

PLASTIC STANDOFF 27mm

15.252		27mm	x20 
--------	---	------	---

PLASTIC STANDOFF 14.4mm

15.253		14.4mm	x20 
--------	---	--------	---

WHITE FIX STANDOFFS



* Custom printing is available but not included. The mounting screws are not included.

FIXING STANDOFF Push Standoffs

SIGN DETAILS



INSTALLING EXPLANATION

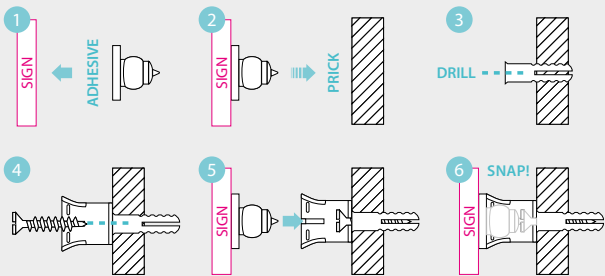

DIMENSIONS

*mm

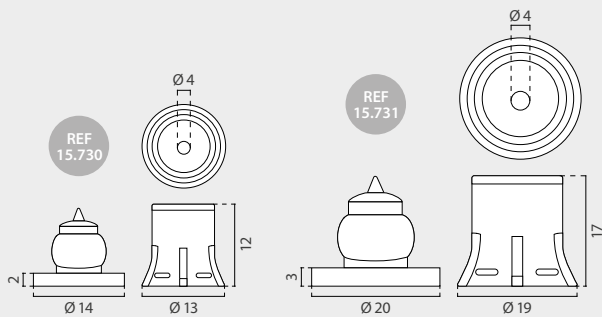

INFORMATION

These transparent standoffs allow to separate the signal, letter or directory from the wall, adding a separation effect to gain more visual impact. Also, thanks to being transparent, they allow a complete integration in the finish. They are ideal for generating sign letters or directories for classrooms, hotels, hospitals, libraries, offices, banks or for travel agencies.

TRANSPARENT PUSH STANDOFF

REF.	SIZE	UNIT PACK
15.730	Ø14x14mm	x10 
15.731	Ø19x20mm	x10 

* Custom printing is available but not included. The mounting screws are not included.

TRANSPARENT SNAP STANDOFFS

new



FIXING STANDOFF Push Standoffs

SIGN DETAILS



EXTERNAL SIZES

*mm

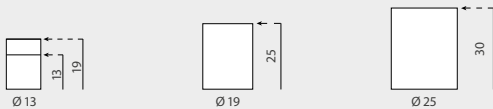

Ø13x13mm

	COLOR	SIZE		
15.528		Ø13x13mm	x4	
15.532		Ø13x13mm	x4	
15.536		Ø13x13mm	x4	
15.540		Ø13x13mm	x4	

Ø13x19mm

	COLOR	SIZE		
15.529		Ø13x19mm	x4	
15.533		Ø13x19mm	x4	
15.537		Ø13x19mm	x4	
15.541		Ø13x19mm	x4	

Ø19x25mm

	COLOR	SIZE		
15.530		Ø19x25mm	x4	
15.534		Ø19x25mm	x4	
15.538		Ø19x25mm	x4	
15.542		Ø19x25mm	x4	

Ø25x30mm

	COLOR	SIZE		
15.531		Ø25x30mm	x4	
15.535		Ø25x30mm	x4	
15.539		Ø25x30mm	x4	
15.543		Ø25x30mm	x4	

COLOR ALUMINIUM STANDOFF



* Custom printing is available but not included. The mounting screws are not included.

FIXING STANDOFF Push Standoffs

SIGN DETAILS







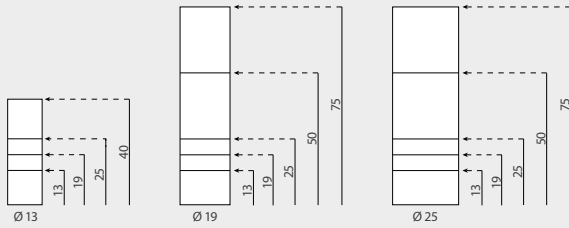





EXTERNAL SIZES

*mm









GOLD-CHROMED STANDOFF Ø13mm

COLOR	SIZE		
15.500		Ø13x13mm	x4 
15.501		Ø13x19mm	x4 
15.502		Ø13x25mm	x4 
15.503		Ø13x40mm	x4 

COLOR	SIZE		
15.504		Ø13x13mm	x4 
15.505		Ø13x19mm	x4 
15.506		Ø13x25mm	x4 
15.507		Ø13x40mm	x4 

GOLD-CHROMED STANDOFF Ø19mm







COLOR	SIZE		
15.508		Ø19x13mm	x4 
15.509		Ø19x19mm	x4 
15.510		Ø19x25mm	x4 
15.511		Ø19x50mm	x4 
15.512		Ø19x75mm	x4 







COLOR	SIZE		
15.513		Ø19x13mm	x4 
15.514		Ø19x19mm	x4 
15.515		Ø19x25mm	x4 
15.516		Ø19x50mm	x4 
15.517		Ø19x75mm	x4 

GOLDEN-CHROMED STANDOFF



GOLD-CHROMED STANDOFF Ø25mm

COLOR	SIZE		
15.518		Ø25x13mm	x4 
15.519		Ø25x19mm	x4 
15.520		Ø25x25mm	x4 
15.521		Ø25x50mm	x4 
15.522		Ø25x75mm	x4 

COLOR	SIZE		
15.523		Ø25x13mm	x4 
15.524		Ø25x19mm	x4 
15.525		Ø25x25mm	x4 
15.526		Ø25x50mm	x4 
15.527		Ø25x75mm	x4 

* Custom printing is available but not included. The mounting screws are not included.

FIXING STANDOFF Cover & Desktop Standoffs

SIGN DETAILS









INFORMATION

Covers are ideal for creating name plates and guidance systems made of glass. Simple and stylish, they allow you to highlight your details.

CHROMED

	COLOR	SIZE		
15.544		Ø15mm	x4 	
15.545		Ø19mm	x4 	
15.546		Ø25mm	x4 	

GOLDEN

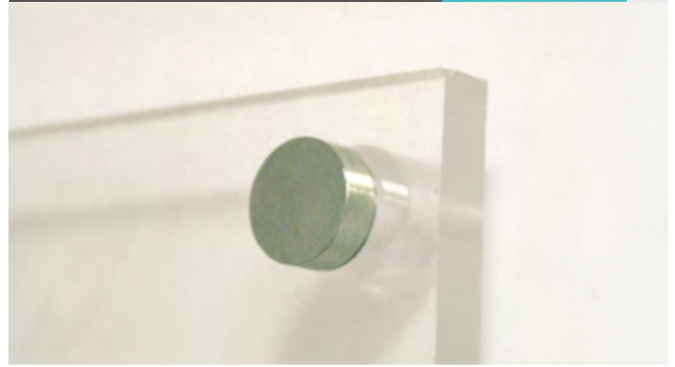

	COLOR	SIZE		
15.547		Ø15mm	x4 	
15.548		Ø19mm	x4 	
15.549		Ø25mm	x4 	

SCREW COVERS





STANDOFF DETAILS



	COLOR	SIZE		
15.567		Ø8x80mm	x2 	



STANDOFF DETAILS



	COLOR	SIZE		
15.569		Ø8x80mm	x2 	



STANDOFF DETAILS



	COLOR	SIZE		
15.568		Ø8x80mm	x2 	

STANDOFF DETAILS



	COLOR	SIZE		
15.570		Ø8x80mm	x2 	

STEEL DESK SUPPORT



INFORMATION

Covers are ideal for creating name plates and guidance systems made of glass. Simple and stylish, they allow you to highlight your details.

OUTDOOR SIGN SYSTEM



EXTERNAL SIZES

*mm

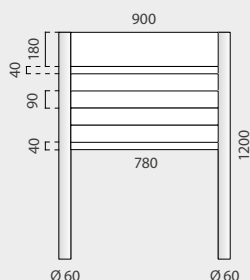

INFORMATION

This sign includes:

- 2 aluminium poles (Ø60x1200mm)
 - 2 plastic endcaps per post
 - 1 aluminium profile 180mm height
 - 2 aluminium profiles 40mm height
 - 4 aluminium profiles 90mm height
- It is ideal for creating outdoor guidance systems.

OUTDOOR SIGN

SIZE

15.716

900x1200mm

EXTERNAL SIZES

*mm

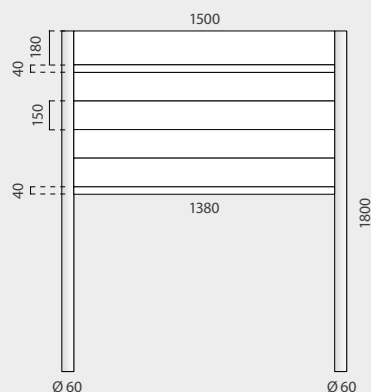

INFORMATION

This sign includes:

- 2 aluminium poles (Ø60x1800mm)
 - 2 plastic endcaps per post
 - 1 aluminium profile 180mm height
 - 2 aluminium profiles 40mm height
 - 4 aluminium profiles 150mm height
- It is ideal for creating outdoor guidance systems.

OUTDOOR SIGN

SIZE

15.717

1500x1800mm

DIN SIZES AND DINA FORMATS

A0	841x1189mm
A1	594x841mm
A2	420x594mm
A3	297x420mm

A4	210x297mm
A5	148x210mm
A6	105x148mm
A7	74x105mm

A8	52x74mm
A9	37x52mm
A10	26x37mm

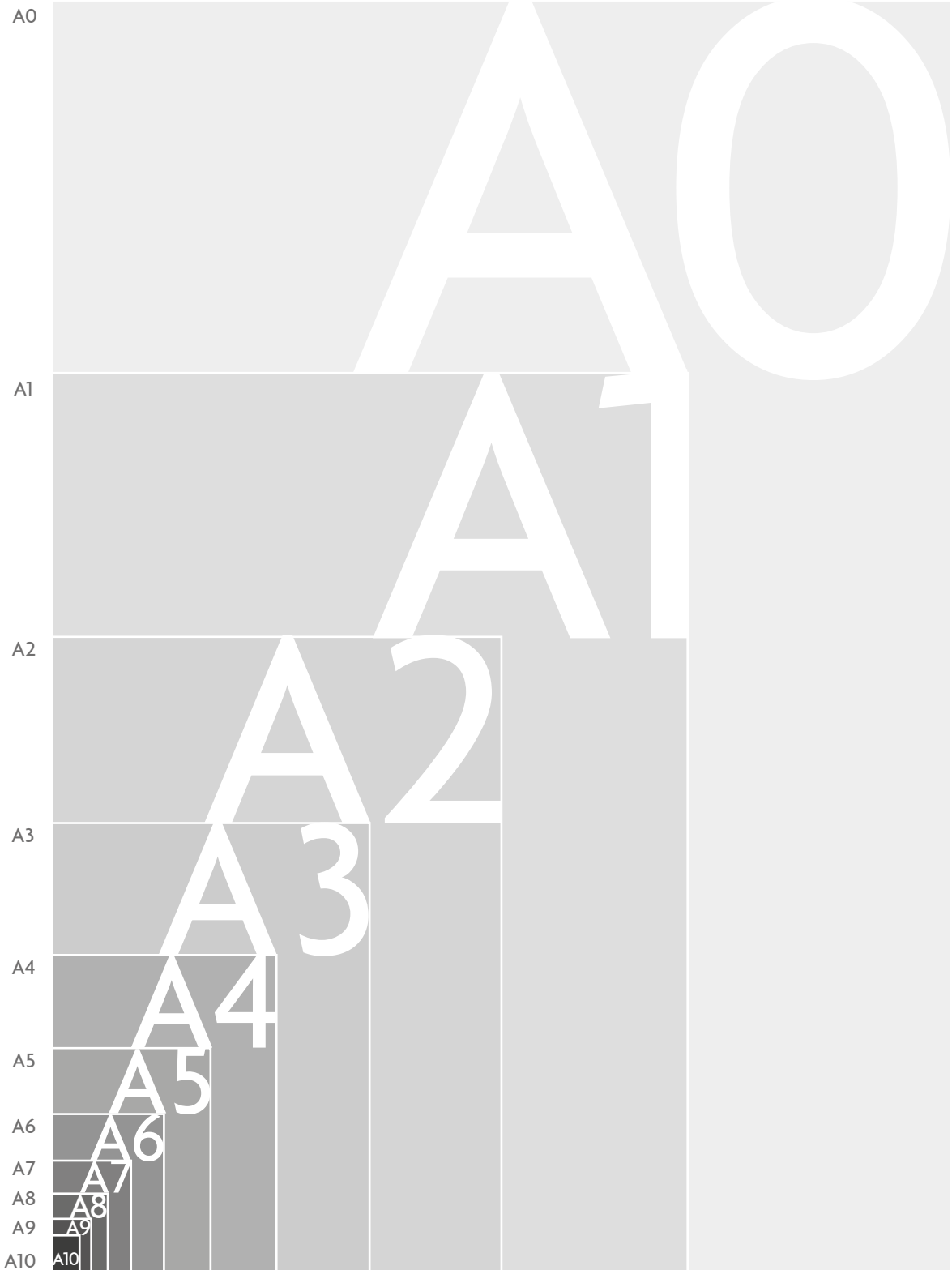



Cable Kit

09

Complete range of signage systems through steel cables and tensors which provide an complete solution for the exhibition at selling point areas.



- 412** OMEGA SYSTEM
- 414** DELTA SYSTEM
- 416** GAMMA SYSTEM
- 418** EPSILON SYSTEM
- 420** FREE STANDING
- 421** ACRYLIC POCKET
- 422** LIGHT BOX



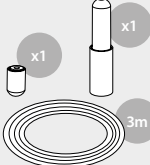

OMEGA FIXING KIT

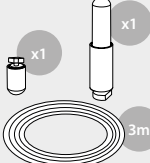
DETAIL	KIT INCLUDES	INFORMATION
		Fixing kit contains: 3m length wire cable + 1 top fixing unit + 1 bottom fixing unit. The Omega Kit is ideal for storefronts, travel agencies or for banks.
FIXING KIT		
12.547	x2 	



OMEGA CHANNEL KIT

DETAIL	KIT INCLUDES	INFORMATION
		Channel kit contains: 3m length wire cable + 1 top channel unit + 1 bottom channel unit. Omega Kit is ideal for storefronts, travel agencies or for banks.
CHANNEL KIT		
12.546	x2 	



OMEGA TOP FIXING

DETAIL	SIZE *mm	INFORMATION
		This metallic unit is suitable for a top fixation with the ceiling. It features a satin silver finish.
TOP FIXING	SIZE	
12.544	Ø14x24mm	x10 

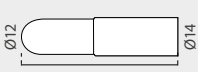

OMEGA TOP CHANNEL

DETAIL	SIZE *mm	INFORMATION
		This metallic unit is suitable for a top fixation with channel connector. It features a satin silver finish.
TOP CHANNEL	SIZE	
12.542	Ø14x26mm	x10 

OMEGA BOTTOM FIXING

DETAIL	SIZE *mm	INFORMATION
		Metallic unit for a bottom fixation with the floor. With a satin silver finish.
BOT. FIXING	SIZE	
12.545	Ø14x57mm	x10 

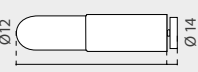
OMEGA BOTTOM CHANNEL



DETAIL	SIZE *mm	INFORMATION
		Metallic unit for being used with channel connector. With a satin silver finish.
BOT. CHANNEL	SIZE	
12.543	Ø14x59mm	x10 

OMEGA SYSTEM



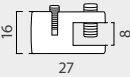

* Acrylic Pockets at this page are available but not included

OMEGA SINGLE POCKET CLIP

DETAIL	SIZE	*mm	INFORMATION
			This metallic single pocket clip is suitable for wires up to Ø1.5mm - Ø3mm. With silver finish.
SINGLE CLIP	SIZE		
12.540	Ø16x27mm	x10 	

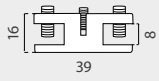



OMEGA DOUBLE POCKET CLIP

DETAIL	SIZE	*mm	INFORMATION
			Double metallic single panel clip for wires up to Ø1.5mm - Ø3mm. With silver finish.
DOUBLE CLIP	SIZE		
12.541	Ø16x39mm	x10 	

ALUMINIUM TRACK

DETAIL	INFORMATION
	This track aluminium features 2 lengths available (2m or 3m).
TRACK	LENGTH
12.127	2000mm
12.128	3000mm

TRACK ENDCAP



DETAIL	SIZE	*mm	INFORMATION
			Connect this endcap to the aluminium track. Made of gray plastic.
ENCAP	SIZE		
12.428	31x25mm	x10 	

WIRE CABLE

DETAILS	INFORMATION		
			
WIRE CABLE	LENGTH	Ø WIRE	
12.315	25m	1.5mm	
12.311	25m	3mm	

Roll of wire cable suitable for Cablekit systems, with a length of 25m. 2 diameters available: Ø1.5mm and Ø3mm.







OMEGA LOAD

DETAIL	SIZE	*mm	INFORMATION
			This Ø40 Aluminium load for wires is 500g weight. 170mm height.
LOAD	SIZE	WEIGHT	
12.117	Ø40x170mm	500g	





OMEGA SYSTEM



ACRYLIC POCKET

POCKET	STANDARD FORMATS	*mm
		
12.125	A4 Horizontal	x10 
12.351	A3 Horizontal	x10 
12.126	A4 Vertical	x10 
12.352	A3 Vertical	x10 

This transparent 2mm acrylic Pocket folder features 2 formats with 2 orientations.

POCKET	STANDARD FORMATS	*mm
12.125	A4 Horizontal	x10 
12.351	A3 Horizontal	x10 
12.126	A4 Vertical	x10 
12.352	A3 Vertical	x10 

DELTA TOP/WALL FIXING

FIXING DETAIL INFORMATION *mm

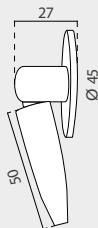

This movable and stylish Top Support is suitable for ceiling or wall. It includes adjust for tension. Convenient for wire with a diameter of Ø1.5mm or Ø3mm. With chrome finish. Ideal for storefronts, travel agencies or banks.

WALL FIXING	BASE SIZE		
12.316	Ø45x27mm	x4	

DELTA TOP/BOTTOM FIXING

FIXING DETAIL INFORMATION *mm

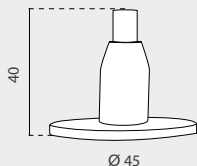

Elegant and fixed support for ceiling or floor. Convenient for wire with a diameter of Ø1.5mm or Ø3mm. With chrome finish. Ideal for real states, storefronts, travel agencies or banks.

BOTTOM FIXING	SIZE		
12.317	Ø45x40mm	x4	

CHROMED POCKET CLIP

CLIP DETAIL SIZE *mm INFORMATION

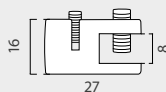

This chromed pocket fixing Clip is suitable for a single pocket. It is convenient for wire with a diameter of Ø1.5mm or Ø3mm.

CHROMED CLIP	SIZE		
12.318	Ø16x27mm	x10	

DOUBLE CHROMED POCKET CLIP

CLIP DETAIL SIZE *mm INFORMATION

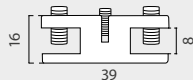

This chromed pocket fixing Clip is suitable for 2 pockets. It is convenient for wire with a diameter of Ø1.5mm or Ø3mm.

DOUBLE CH.	SIZE		
12.319	Ø16x39mm	x10	

DELTA SYSTEM

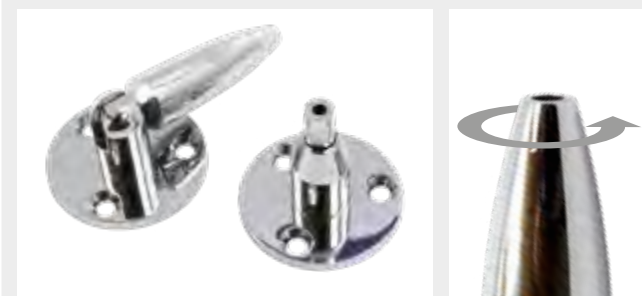

* Acrylic Pockets at this page are available but not included

WIRE CABLE Ø 1mm

CABLE DETAIL

INFORMATION



Roll of wire cable suitable for Cablekit systems. With a diameter of Ø1mm and a length of 25m. This hanging wire cable provides tension and firmness to the displaying of pockets.

Ø1 CABLE	LENGTH	Ø WIRE
12.121	25m	1mm

WIRE CABLE Ø 1.5mm

CABLE DETAIL

INFORMATION



Roll of wire cable suitable for Cablekit systems. With a diameter of Ø1.5mm and a length of 25m. This hanging wire cable provides tension and firmness to the displaying of pockets.

Ø1.5 CABLE	LENGTH	Ø WIRE
12.315	25m	1.5mm

WIRE CABLE Ø 3mm

CABLE DETAIL

INFORMATION

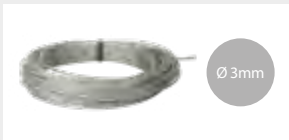

Roll of wire cable suitable for Cablekit systems. With a diameter of Ø3mm and a length of 25m. This hanging wire cable provides tension and firmness to the displaying of pockets.

Ø3 CABLE	LENGTH	Ø WIRE
12.311	25m	3mm

ACRYLIC POCKET



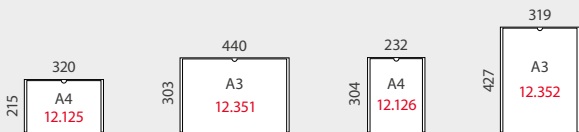

acrylic

*mm



This transparent 2mm acrylic Pocket folder features 2 formats with 2 orientations.

POCKET	STANDARD FORMATS			
12.125	A4 Horizontal	x10		
12.351	A3 Horizontal	x10		
12.126	A4 Vertical	x10		
12.352	A3 Vertical	x10		

DELTA SYSTEM



GAMMA TOP/WALL FIXING

FIXING DETAIL SIZE *mm

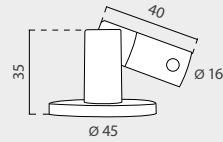

INFORMATION

This movable and stylish Top Support is suitable for ceiling or wall. Convenient for wire with a diameter of Ø1.5mm or Ø3mm. With chrome finish. It is ideal for storefronts, travel agencies or banks.

WALL FIXING	BASE SIZE	
12.312	Ø45x35mm	x4 

GAMMA WALL/BOTTOM FIXING

FIXING DETAIL SIZE *mm

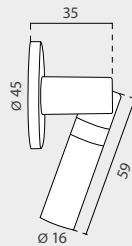

INFORMATION

This movable and stylish bottom support is suitable for wall or floor placement. It includes adjust for tension Convenient for cable wire up to Ø1.5 - Ø3mm. With silver finish. Ideal for real states, for storefronts, travel agencies or banks, creating advertisement mosaics.

BOTTOM FIXING	BASE SIZE	
12.313	Ø45x35mm	x4 

GAMMA SINGLE POCKET CLIP

CLIP DETAIL



INFORMATION SIZE *mm

This silver Vertical fixing Clip is suitable for holding a single panel. Convenient for cable wire with a diameter of Ø1.5mm or Ø3mm.

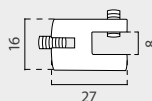

CHROMED CLIP	SIZE	
12.314	Ø16x27mm	x10 

GAMMA SYSTEM



* Acrylic Pockets at this page are available but not included

GAMMA SYSTEM

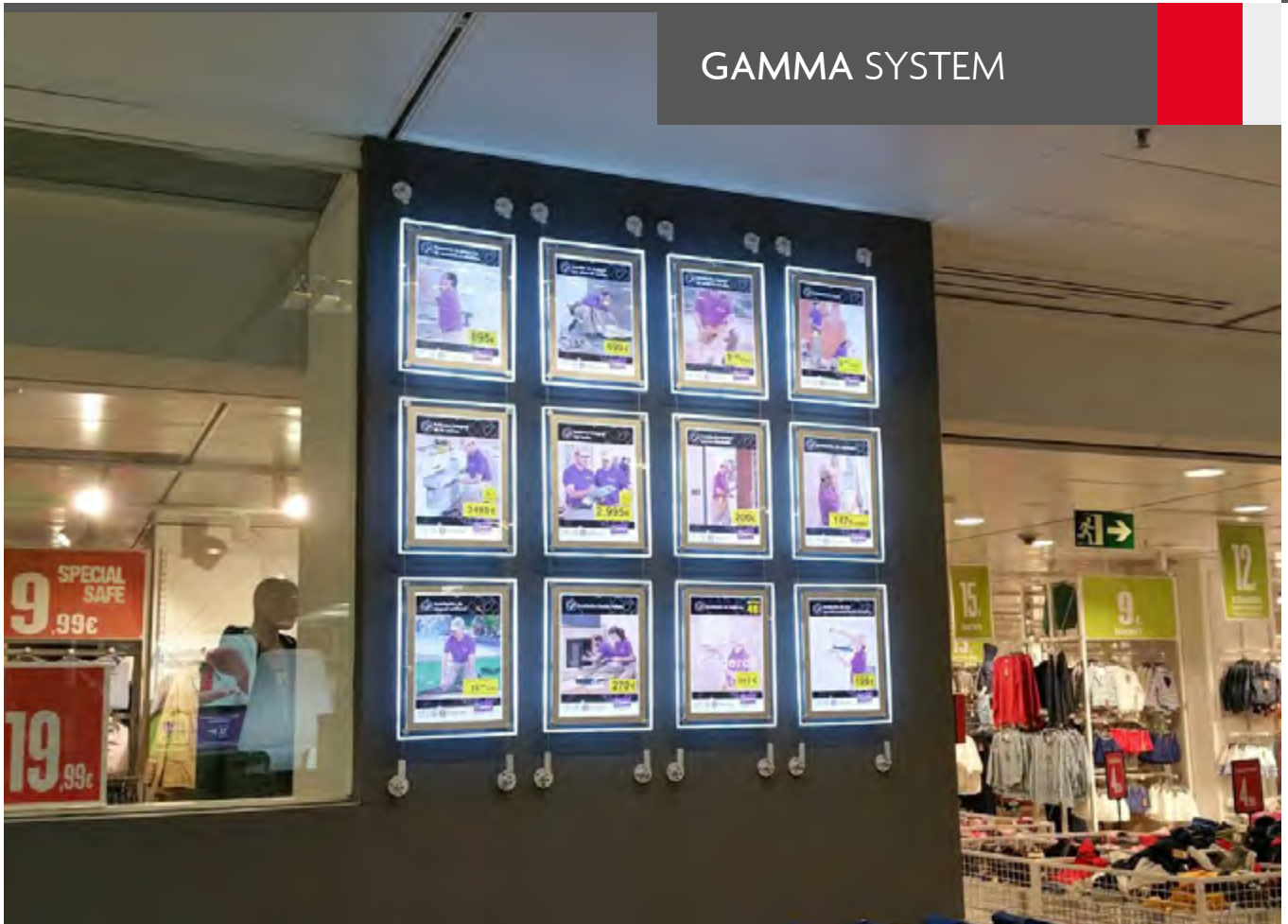

WIRE CABLE Ø 1.5mm

CABLE DETAIL

INFORMATION

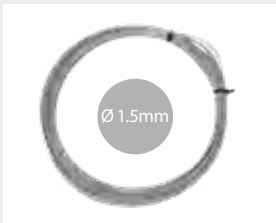

Roll of wire cable suitable for Cablekit systems. With a diameter of Ø1.5mm and a length of 25m. This hanging wire cable provides tension and firmness to the displaying of pockets.

Ø1.5 CABLE	LENGTH	Ø WIRE
12.315	25m	1.5mm

WIRE CABLE Ø 3mm

CABLE DETAIL

INFORMATION









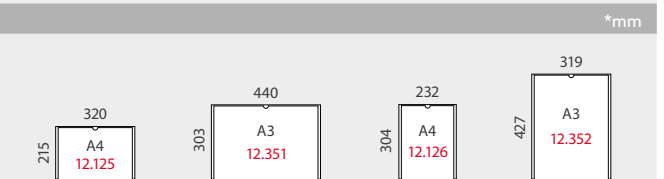

Roll of wire cable suitable for Cablekit systems. With a diameter of Ø3mm and a length of 25m. This hanging wire cable provides tension and firmness to the displaying of pockets.

Ø3 CABLE	LENGTH	Ø WIRE
12.311	25m	3mm

ACRYLIC POCKET



This transparent 2mm acrylic Pocket folder features 2 formats with 2 orientations.

POCKET	STANDARD FORMATS			
12.125	A4 Horizontal	x10		
12.351	A3 Horizontal	x10		
12.126	A4 Vertical	x10		
12.352	A3 Vertical	x10		

* Magnetic Light Boxes at this page are available but not included

EPSILON TOP/WALL FIXING

FIXING DETAIL INFORMATION *mm

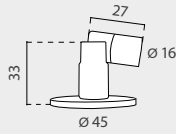

This movable and stylish Support is suitable for ceiling or wall. Convenient for cable wire up to Ø1.5 - Ø3mm. With chrome finish. Ideal for real states, for storefronts, travel agencies or banks.

BOTTOM FIXING	SIZE	
12.320	Ø45x40mm	x4 

EPSILON WALL/BOTTOM FIXING

FIXING DETAIL INFORMATION *mm

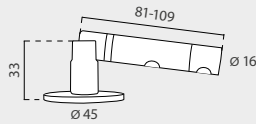

This movable and stylish Support is suitable for bottom/floor or wall. It includes adjust for tension. Convenient for cable wire up to Ø1.5 - Ø3mm. With chrome finish. Ideal for real states, travel agencies or banks.

WALL FIXING	BASE SIZE	
12.321	Ø45x33mm	x4 

CHROMED POCKET CLIP

CLIP DETAIL INFORMATION *mm

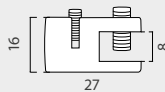

This chromed pocket fixing Clip is suitable for a single pocket. It is convenient for wire with a diameter of Ø1.5mm or Ø3mm.

CHROMED CLIP	SIZE	
12.318	Ø16x27mm	x10 

DOUBLE CHROMED POCKET CLIP

CLIP DETAIL INFORMATION *mm

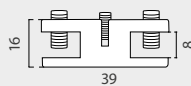

This chromed pocket fixing Clip is suitable for 2 pockets. It is convenient for wire with a diameter of Ø1.5mm or Ø3mm.

DOUBLE CH.	SIZE	
12.319	Ø16x39mm	x10 

EPSILON SYSTEM

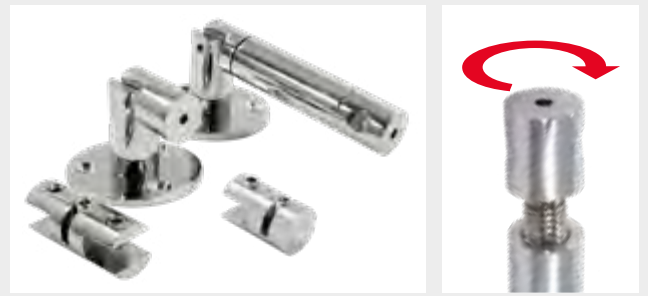

* Acrylic Pockets at this page are available but not included

WIRE CABLE Ø 1mm

CABLE DETAIL

INFORMATION

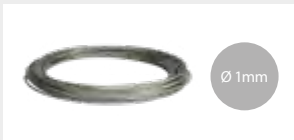

Roll of wire cable suitable for Cablekit systems. With a diameter of Ø1mm and a length of 25m. This hanging wire cable provides tension and firmness to the displaying of pockets.

Ø1 CABLE	LENGTH	Ø WIRE
12.121	25m	1mm

WIRE CABLE Ø 1.5mm

CABLE DETAIL

INFORMATION



Roll of wire cable suitable for Cablekit systems. With a diameter of Ø1.5mm and a length of 25m. This hanging wire cable provides tension and firmness to the displaying of pockets.

Ø1.5 CABLE	LENGTH	Ø WIRE
12.315	25m	1.5mm

WIRE CABLE Ø 3mm

CABLE DETAIL

INFORMATION

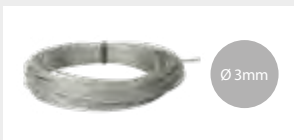

Roll of wire cable suitable for Cablekit systems. With a diameter of Ø3mm and a length of 25m. This hanging wire cable provides tension and firmness to the displaying of pockets.

Ø3 CABLE	LENGTH	Ø WIRE
12.311	25m	3mm



ACRYLIC POCKET

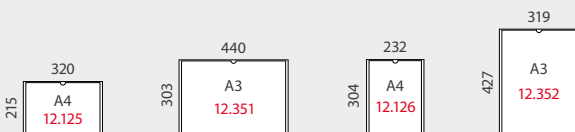

*mm



This transparent 2mm acrylic Pocket folder features 2 formats with 2 orientations.

POCKET	STANDARD FORMATS			
12.125	A4 Horizontal	x10		
12.351	A3 Horizontal	x10		
12.126	A4 Vertical	x10		
12.352	A3 Vertical	x10		

EPSILON SYSTEM



FREE STANDING Free Standing

FREE STANDING



*mm

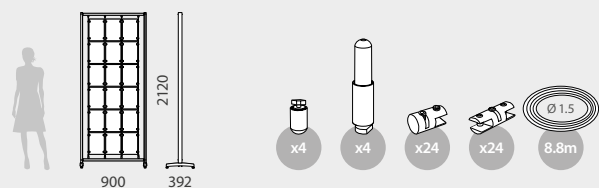

*mm

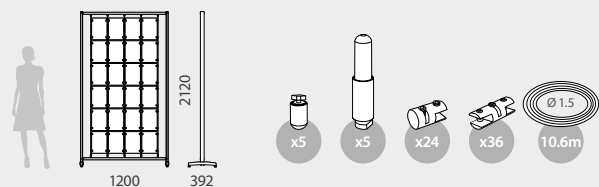

*mm

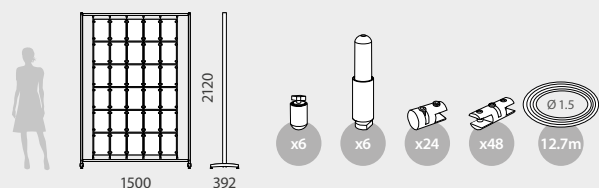

The Free Standing is a cable support system for aluminum frame with feet and levelers. Featuring 3 different models. Every kit of Free Standing includes: 1 aluminium Framework, Top connectors, Bottom connectors, Single pocket clips, Double pocket clips and Ø1.5mm cable. Acrylic pockets not included.

FREE STANDING	OUTER SIZE
12.354	900x2120x392mm
12.355	1200x2120x392mm
12.356	1500x2120x392mm



* Acrylic Pockets at this page are available but not included



*mm

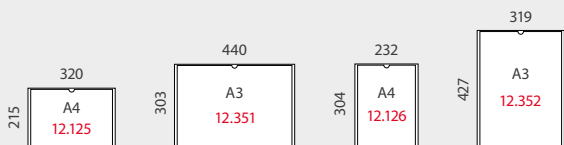

These transparent Pocket folders are made of 2mm acrylic thickness and 2 sizes are available (A3 and A4). It features an easy and simple graphic change. Also, portrait and landscape orientation of both sizes are available. These holder pockets can be used in a wide range of ways so users can create their own display based on their needs.

POCKET	STANDARD FORMATS				
12.125	A4 Horizontal	x10			
12.351	A3 Horizontal	x10			
12.126	A4 Vertical	x10			
12.352	A3 Vertical	x10			

ACRYLIC POCKET



* The Cable kit system at this page are available but not included with the acrylic pockets.



*mm

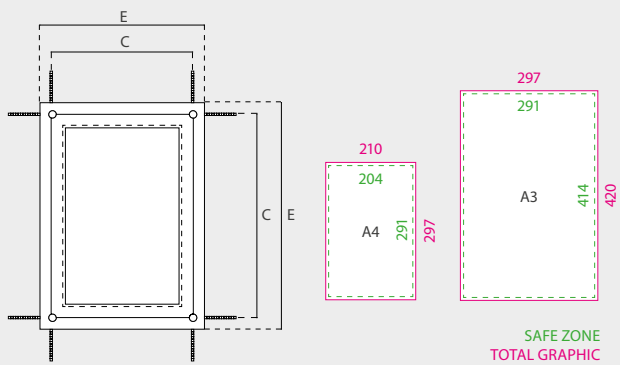

LIGHTBOX SIZE	E (EXTERNAL)	C (CABLE DISTANCE)	BRIGHTNESS	VOLTAGE	POWER
A4	276x363mm	240x327mm	≥ 1500LUX	12V	4.8W
A3	363x486mm	327x450mm	≥ 1500LUX	12V	9.6W

Light Boxes use 12V safe power and ultra bright LED lights and they are suitable for being used with any of the CableKit systems. Light Boxes feature a magnetic sealed design which makes it easy and fast to change the graphics. Compatible up to Ø1.5mm cable, these holder boxes can be used in a wide range of ways so users can create their own light display based on their needs. **Not suitable for use with aluminium track (ref. 12.127 and 12.128).** It features 2 formats (A4 and A3) with double sided format. The Kit Power Supply and its Power Connector are supplied separately. Ideal for being used on showcases, art expositions, storefronts, restaurants, hotels, banks, travel agencies, etc...

DOUBLE A4	QTY	N.W	G.W	C.B.M	SIZE
Packing	2	2.1kg	2.5kg	0.121	410x330x90mm
		Graphic size		External size	
12.550	2 Sided A4	363x276x8mm		x2	

DOUBLE A3	QTY	N.W	G.W	C.B.M	SIZE
Packing	2	3.5kg	4kg	0.02	550x410x90mm
		Graphic size		External size	
12.551	2 Sided A3	486x363x8mm		x2	

LIGHT BOX



KIT POWER SUPPLY FOR LIGHT BOX

POWER SUPPLY DETAILS

KIT INCLUDES



INFORMATION

Supply Kit has 12V safe power and contains 1 Power Cord and 1 Connector cable.

POWER SUPPLY	POWER	CABLE LENGTH
12.552	12V 2A	2.5+1.5m

POWER CONNECTOR FOR LIGHT BOX

CONNECTORS DETAILS

SIZE

*mm

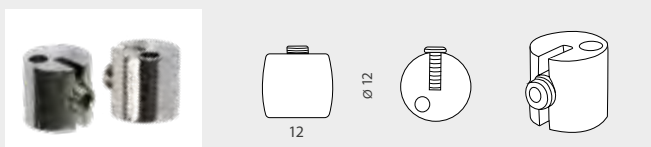

INFORMATION

These Power Connectors join the LED Lightboxes with the tension wire cable.

CONNECTOR	SIZE
12.553	Ø12x12mm x4 

FOR ANY CABLEKIT SYSTEM AVAILABLE

CABLE KIT DETAILS



INFORMATION

Light Boxes are suitable for being used with any of our CableKit systems.

WIRE CABLE

CABLE DETAILS

INFORMATION

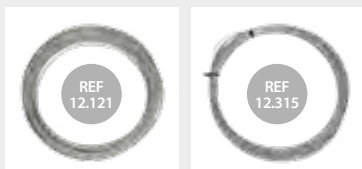

Roll of wire cable suitable for Cablekit systems, with a length of 25m. 2 diameters available: Ø1mm and Ø1.5mm.

WIRE CABLE	LENGTH	Ø WIRE
12.121	25m	1mm
12.315	25m	1.5mm

LIGHT BOX







Product
Exhibition

10

Complete range of dispenser displays, tower and shelf units for the product exhibition which provide an integral solution for the selling exhibition.

- 426 SHELVING DISPLAYS
- 429 DISPENSER DISPLAYS
- 435 BOWL DISPENSERS
- 437 CARDBOARD DISPLAYS
- 440 TURNTABLES
- 443 CUBE SYSTEM
- 444 ACRYLIC DISPLAYS
- 455 DISPLAY STANDS



SHELVING DISPLAY Multifunction Shelf

SHELVES + COVERS + CAPS

CUSTOMIZATION PACK 1



TINEO PACK 1	QTY	N.W	G.W	C.B.M	SIZE
Packing	1	4.1kg	4.6kg	0.0437	420x400x260mm
Color	<input checked="" type="checkbox"/>	<input checked="" type="checkbox"/>	<input checked="" type="checkbox"/>	<input type="checkbox"/>	
13.719	4 Shelves + 4 Top Covers + 4 End Caps				

DIMENSIONS

*mm



INFORMATION

With exposed sides, this 4-sided plastic shelving unit lets customers easily access the items on display while also providing you a means to quickly restock. Customize your Tineo and choose 1 color for a first pack of 4 shelves (A) 4 top covers (B) and 4 end caps (C). Then choose a second color for the pack of 12 Poles (D) and 4 Bottom Feet (E). Tineo has multiple functions for selling, displaying or promoting products, so it is a practical shelving unit that will look great in markets, retail stores, exhibition events or even at home.

POLES + FEET

CUSTOMIZATION PACK 2

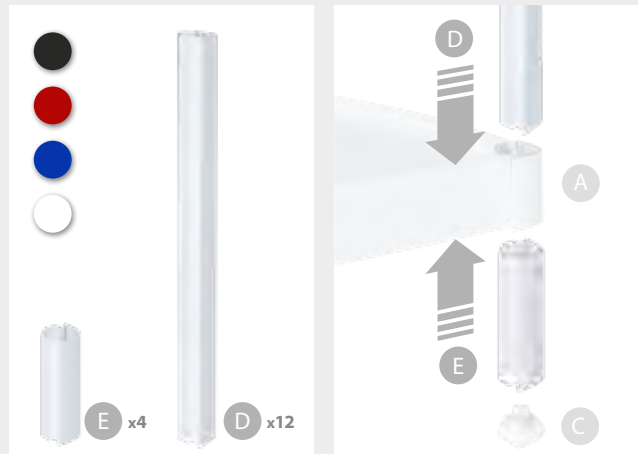

TINEO PACK 2	QTY	N.W	G.W	C.B.M	SIZE
Packing	1	1.70kg	2.05kg	0.0110	415x355x75mm
Color	<input checked="" type="checkbox"/>	<input checked="" type="checkbox"/>	<input checked="" type="checkbox"/>	<input type="checkbox"/>	
13.720	12 Poles + 4 Bottom Feet				

TINEO MULTIFUNCTION SHELF STAND



SHELVING DISPLAY Multifunction Shelf

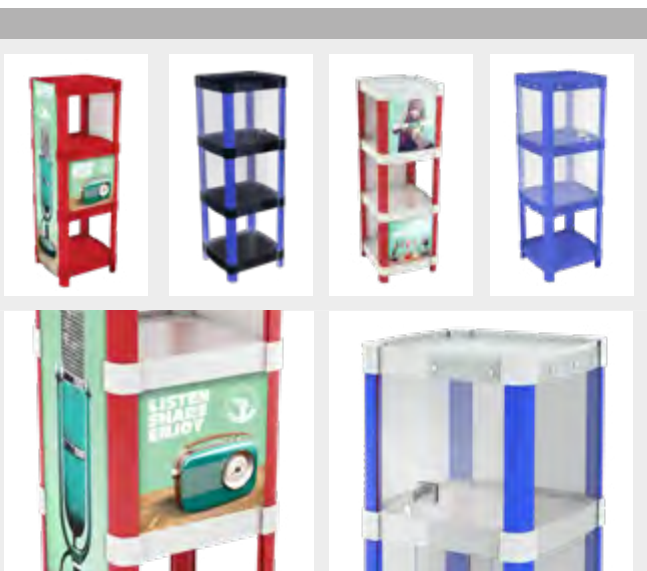

To make things even easier, the Multi-function Tineo Shelf Stand is designed to support new configurations applied by the customer, such as turning it into a display cabinet unit by using panels or incorporating graphics to the sides. Easy to assemble, each piece is designed for quick installation and use. Also, if you want to turn this shelf display to mobile, wheels for Tineo Shelf Stand are also available.



WHEELS FOR TINEO



WHEELS	QTY	N.W	G.W	C.B.M	SIZE
Packing	4	0.3kg	0.35kg	0.0008	130x105x60mm
14.102	2 Wheels + 2 Brake Wheels		x4		

FEET FOR TINEO



FEET	QTY	N.W	G.W	C.B.M	SIZE
Packing	4	0.084kg	0.13kg	0.0005	70x105x70mm
14.202	4 Adjustable feet		x4		

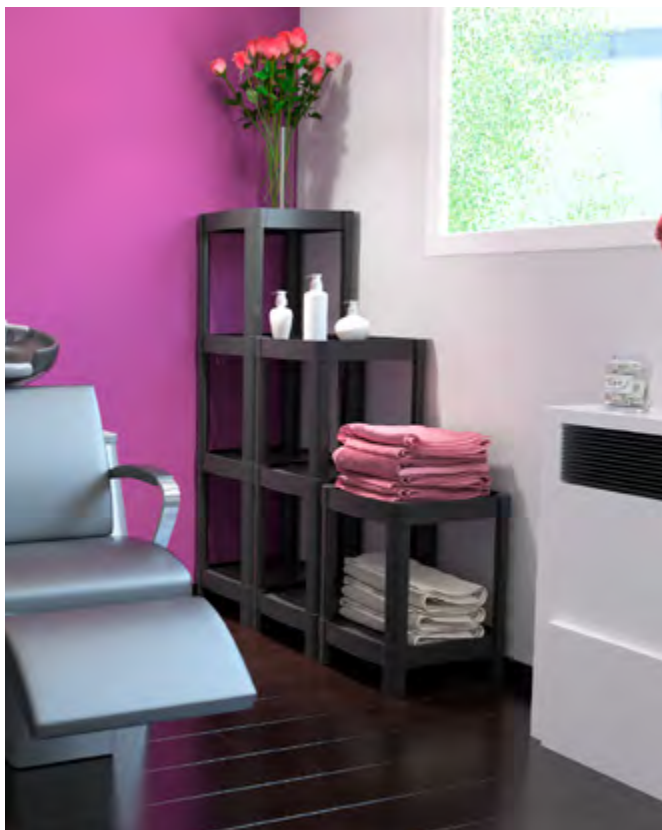

* Customization options are not included. / * Les possibles personnalisation ne sont pas incluses. / * As possibilidades de personalização em nenhum caso são fornecidas. / * Las opciones de personalización no están incluidas.

SHELVING DISPLAY Multifunction Shelf

DISPLAY DETAILS



*mm

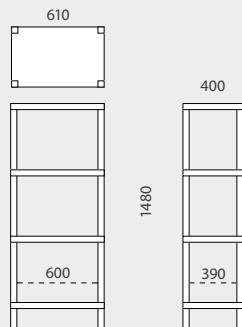

The Shelf display is fully removable, also it is lightweight and it features 4 different colors available. With exposed sides, this 4-sided plastic shelving unit lets customers easily access the items on the display while also providing you a means to quickly restock. Easy to set up in only a few seconds, this shelving display will look great in supermarkets or retail stores, supermarkets, exhibition events or even at home.

SHELF D.	QTY	N.W	G.W	C.B.M	SIZE
Packing	1	8kg	8.45kg	0.073	400x290x630mm

10.384	<input type="checkbox"/>				620x400x1480mm
10.386	<input checked="" type="checkbox"/>				
10.387	<input checked="" type="checkbox"/>				
10.388	<input checked="" type="checkbox"/>				

SHELF DISPLAY

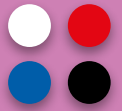

DISPLAY DETAILS



*mm

This "Easy" Display is made of injected plastic with cardboard. It has 3 shelves and top surface of a lower module with wheels. So in this way you have 4 spaces for displaying and exhibition of the product. Also, you can add your customised print to the top header and faces of the cardboard lower module (included) to suit your own requirements. This mobile display is very easy to move inside your business. Place the piece near the point of purchase locations for impulse buys on any merchandise you choose.

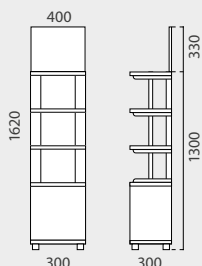

"EASY"	QTY	N.W	G.W	C.B.M	SIZE
Packing	1	4kg	4.8kg	0.0572	520x155x710mm
10.478	Top Graphic Size: 400x330mm				

"EASY" DISPLAY



DISPLAY DETAILS



*mm

Wire steel dumpbin features a collapsible design which allows an easy setup, packing and storing. Frame spacing allows for lifts to be used during store resets. It is ideal for displaying last minute add-on items on the point of sale.

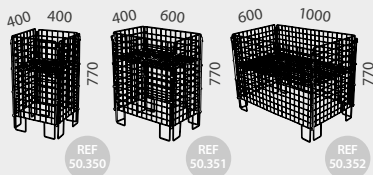

WIRE D1	QTY	N.W	G.W	C.B.M	SIZE
Packing	1	7.2kg	8.4kg	0.2	795x425x550mm
50.350	400x400x770mm				

WIRE D2	QTY	N.W	G.W	C.B.M	SIZE
Packing	1	8.8kg	10.2kg	0.27	795x620x550mm
50.351	600x400x770mm				

WIRE D3	QTY	N.W	G.W	C.B.M	SIZE
Packing	1	13.6kg	15.2kg	0.52	1205x790x550mm
50.352	1000x600x770mm				

WIRE DUMPBIN



PROMO SQUARE DUMPBIN



*mm

This squared transparent dumpbin features 1 shelf and the possibility of placing it in 2 different heights (370mm or 610mm) and get 2 different capacities. Also, you can add your customized print to suit your own requirements. The edge of the upper perimeter is reinforced with protective cover.

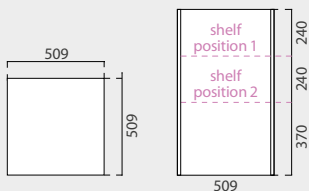

P.SQUARE	QTY	N.W	G.W	C.B.M	SIZE
Packing	1	4.35kg	5.1kg	0.02	540x45x900mm
10.440	Graphic Size: 610x505mm(x4) or 370x505(x4)				



TABLE DISPLAY



*mm

This stand dispenser features 1 front mouth and is easy to set-up. It allows to customize it with your own graphics. Perfect as eye-catching point of purchase presentation on any counter to display the last minute add-on items, for customers to purchase as they are checking out

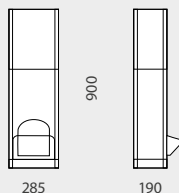

TABLE DISPLAY	QTY	N.W	G.W	C.B.M	SIZE
Packing	1	2.5kg	3.6kg	0.058	300x210x920mm
10.475	Total Display Size: 285x190x900mm				



WALL DISPLAY



*mm

This merchant stand features 1 front mouth and is easy to set-up. It allows to customize it with your own graphics. Perfect as eye-catching point of purchase presentation on any counter to display the last minute add-on items, for customers to purchase as they are checking out

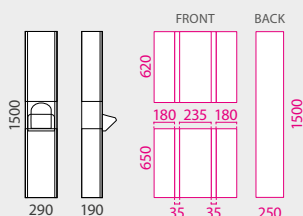

WALL DISPLAY	QTY	N.W	G.W	C.B.M	SIZE
Packing	1	3.7kg	5.46kg	0.1238	335x240x1540mm
10.476	Total Display Size: 290x190x1500mm				



FLOOR DISPLAY



*mm

This floor display features 2 front mouth pieces and is easy to set-up. Ideal as eye-catching point of purchase presentation on any counter to display the last minute add-on items at retail stores, supermarkets, bakeries, toy stores or tradeshows. Personalization with printing on adhesive is available but not included.

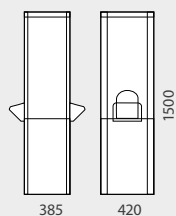

FLOOR DISPLAY	QTY	N.W	G.W	C.B.M	SIZE
Packing	1	7.35kg	8.2kg	0.27	450x400x1520mm
10.477	Total Display Size: 420x385x1500mm				



PROMO SHOP CONFIGURATIONS

*mm



REF 10.108

1165

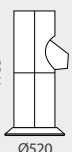

REF 10.109

1165

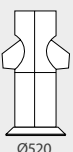

REF 10.102

1715



REF 10.103

1715

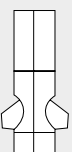

REF 10.104

1715

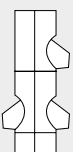

REF 10.105

1715



REF 10.106

SECTIONS ARTWORK

*mm

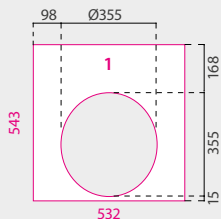
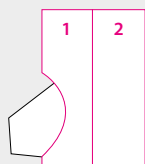

TOTAL GRAPHIC

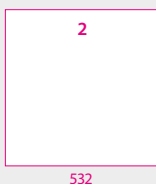

INFORMATION

This merchandiser stand is made of injected plastic and features an easy configuration to set-up. It allows personalization with graphs and a personal configuration, choosing the number of dispensers that require your needs. It is perfect as eye-catching point of purchase presentation at any store.

PROMO SHOP STANDARD GRAPHIC SIZE

PROMO SHOP	STANDARD GRAPHIC SIZE
10.108	Promo Shop ½
10.109	Promo Shop 1
10.102	Promo Shop 2
10.103	Promo Shop 3
10.104	Promo Shop 4
10.105	Promo Shop 5
10.106	Promo Shop 6

PROMO SHOP



DISPLAY DETAILS



DIMENSIONS

*mm

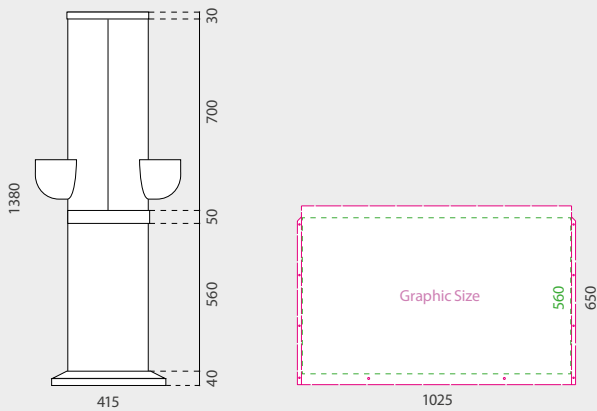

This fully removable merchandising display features 2 dispensers made of plastic and a transparent divided cylinder for the exhibition of 2 classes of products. Also it is available in blue or red color and the base allows the customization with graphic. This Dispenser Display is light weight and easy to set-up. The Promo Store is ideal for the exhibition of toys, candies, cosmetics, merchandising, samples, gifts or last minute add-on items at playstores, malls, shops, etc...

P.STORE	QTY	N.W	G.W	C.B.M	SIZE
Packing	1	2.58kg	3.93kg	0.1762	450x440x880mm
10.110		Graphic Size: 1045x650mm			

PROMO STORE



DISPLAY DETAILS



DIMENSIONS

*mm

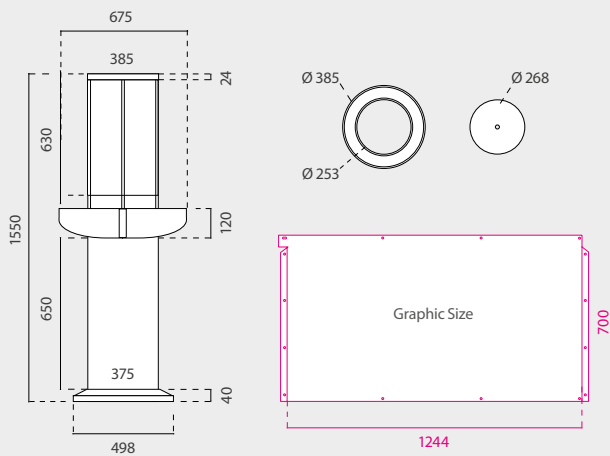

INFORMATION

This dispenser features a 675mm diameter plastic hemisphere. It allows personalization with graphic and is fully removable. Thanks to the easy access to the product, the Promo Bowls are ideal for the exhibition of toys, candies, merchandise, cosmetics, last minute add-on items, merchandising, samples, gifts or last minute add-on items at playstores, malls, shops, etc.

PROMO BRAND	GRAPHIC SIZE
10.429	1244x700mm

PROMO BRAND



BOWL DETAILS

INFORMATION

*mm

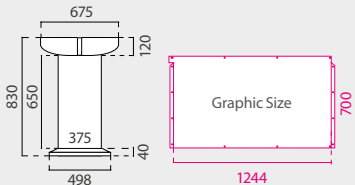
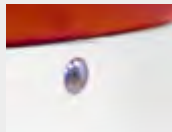

This merchandiser features a $\text{Ø}675\text{mm}$ plastic semisphere. It allows to be customized with a graphic (the printing service is available but not included).

PROMO CASH

GRAPHIC SIZE

13.468

1244x700mm

PROMO CASH



BOWL DETAILS

INFORMATION

*mm

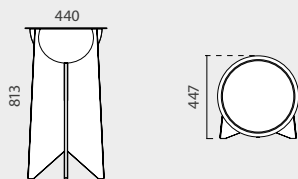

This merchandiser with lightweight wooden base features a $\text{Ø}440\text{mm}$ transparent polycarbonate semisphere. Ideal for the exhibition of last minute add-on items.

W.P.BOWL	QTY	N.W	G.W	C.B.M	SIZE
Semisphere	1	0.75kg	1.85kg	0.0561	492x485x235mm
Wood Base	1	4.95kg	5.75kg	0.0196	900x435x50mm
13.481		Natural Wood			

WOODEN PROMO BOWL



BOWL DETAILS

INFORMATION

*mm

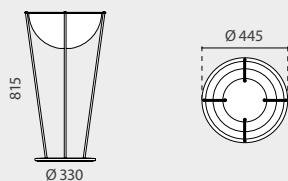

This merchandiser with aluminium base features a $\text{Ø}440\text{mm}$ transparent polycarbonate semisphere. Great visibility for the exhibition of products.

A.P.BOWL	QTY	N.W	G.W	C.B.M	SIZE
Semisphere	1	1.15kg	2.35kg	0.0561	492x485x235mm
Base	1	5kg	5.3kg	0.0055	350x350x45mm
50.383		Semisphere: $\text{Ø}445\text{mm}$ Base: $\text{Ø}330\text{mm}$			

ALUMINIUM PROMO BOWL



BOWL DETAILS



*mm

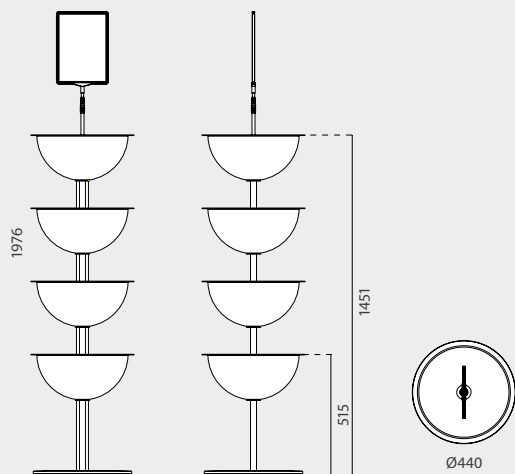

This merchandising multi-bowl is ideal for displaying the last minute add-on items thanks its 440mm diameter semispheres made of transparent polycarbonate. Adding 4 Bowls semispheres for the exhibition of more varieties of product. It features an 8 kg metallic base and includes a frame kit. Perfect for exhibition of candies, cosmetics, hair accessories, and much more.

P.BOWL	QTY	N.W	G.W	C.B.M	SIZE
Semispheres	1	2.45kg	3.50kg	0.074	480x480x320mm
Base+Profile	1	10.4kg	11.55kg	0.099	450x450x490mm
10.802		Semisphere: Ø440mm			

PROMO BOWL



DUMPBIN DETAIL

DIMENSIONS

*mm

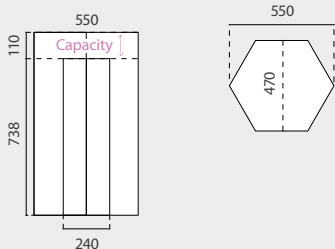

This white coated cardboard dumpbin is very lightweight (only 1.35 kg) and fast to set-up. It's ideal for getting the attention of the customers. Accra's design bets more on product display, allowing a faster access and business output.

ACCRA	QTY	N.W	G.W	C.B.M	SIZE
Packing	1	1.35kg	2kg	0.018	830x25x910mm
13.466					550x470x848mm

ACCRA



DUMPBIN DETAIL

DIMENSIONS

*mm

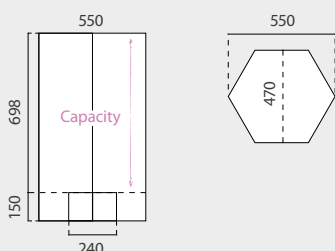

This white coated cardboard dumpbin is lightweight (only 1.35 kg), also it is fast to assemble. It's ideal for getting the attention of the customers. Lagos' design, thanks to its great capacity, bet more for the storage of the products.

LAGOS	QTY	N.W	G.W	C.B.M	SIZE
Packing	1	1.35kg	2kg	0.018	830x25x910mm
13.467					550x470x848mm

LAGOS



DUMPBIN DETAIL

DIMENSIONS

*mm

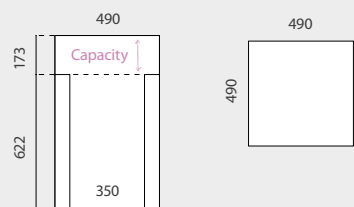

This white coated cardboard dumpbin is very light weight (only 1.15 kg) and also it is fast to set-up. It's ideal for getting the attention of the customers. Berna's design bets more on product display, allowing a faster access and business output.

BERNA	QTY	N.W	G.W	C.B.M	SIZE
Packing	1	1.15kg	1.8kg	0.0255	850x30x1000mm
10.732					490x490x795mm

BERNA



* the filmstrip used on Berna 10.732 is available on chapter 8 Signage, but not included in its price.

PODIUM DETAILS

*mm

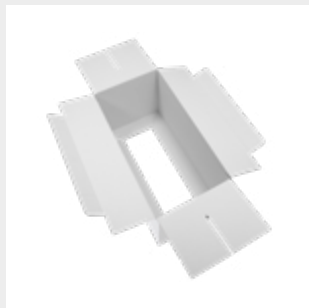

PODIUM SET UP

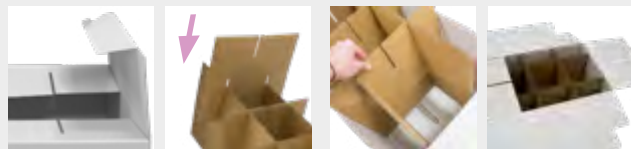

DIMENSIONS

*mm

This cardboard podium stand has a white finish so it is ideal for customizing with your own graphics. It is very lightweight and also very easy to set-up. Its folding design allows to generate a stable platform with a perfectly sealed appearance for promoting. So it's perfect as Eye-catching advertisement for products promoting at points of sale, retail stores, malls, shopping markets or as an exhibitor display to get the attention of the customers.

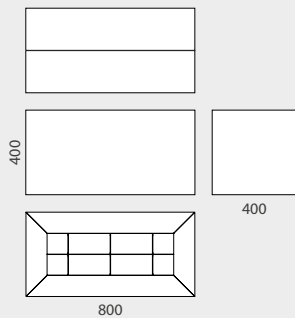

PODIUM	QTY	N.W	G.W	C.B.M	SIZE
Packing	1	2.15kg	3.15kg	0.051	1225x1040x40mm
13.729			400x800x400mm		

PROMOTIONAL
PODIUM STAND



DISPLAY DETAILS



DIMENSIONS

*mm

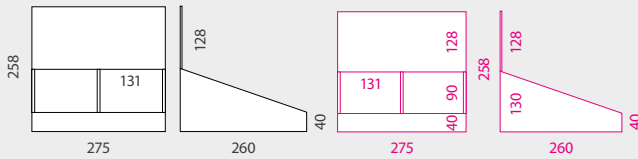

INFORMATION

Burdeos is a Lightweight and white coated display made of 1.5mm thickness cardboard. Easy and fast set up. The removable divider allows 1 or 2 spaces for exhibition. Ideal as eye-catching point of purchase presentation on any counter.

BURDEOS	QTY	N.W	G.W	C.B.M	SIZE
Packing	5	1.1kg	1.44kg	0.0123	570x500x50mm
10.868	275x260x258mm		x5 		

BURDEOS



DISPLAY DETAILS



DIMENSIONS

*mm

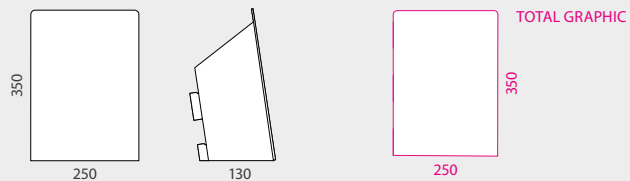

INFORMATION

Budapest is a lightweight and white coated display made of 1.5mm thickness cardboard. Ideal for displaying last minute add-on items, for customers to purchase as they are checking out. Hooks and printing is available but not included.

BUDAPEST	QTY	N.W	G.W	C.B.M	SIZE
Packing	5	0.525kg	0.7kg	0.0038	260x35x415mm
10.831	Graphic size: 250x350mm		x5 		

BUDAPEST



TURNTABLES Turntables

Rotary and pendulum 360° motors for product exhibition.
Different loads and features (LED, solar batteries, etc...).



INFORMATION

*mm

This electric turntable features a Ø410mm circular plate and a maximum load capacity of ±20kg. AC adapter included. Ideal for product display in stores, shop windows, supermarkets or museums.

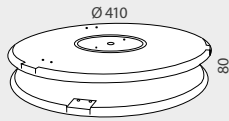

TURN Ø410	QTY	N.W	G.W	C.B.M	SIZE
Packing	1	1.9kg	2.15kg	0.015	420x90x420mm
10.987		Ø410x80mm			

TURNTABLE ±20kg | Ø410mm



ROTARY DETAILS

INFORMATION

*mm

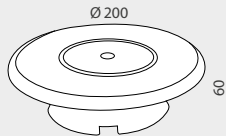

This electric turntable features a Ø200mm circular plate and a maximum load capacity of ±20kg. AC adapter included.

TURN Ø200	QTY	N.W	G.W	C.B.M	SIZE
Packing	1	0.75kg	0.9kg	0.0048	225x75x285mm
10.986		Ø200x60mm			

TURNTABLE ±20kg | Ø200mm



ROTARY DETAILS

INFORMATION

*mm

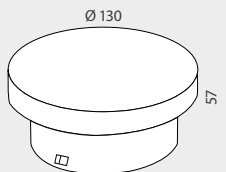

This electric turntable features a Ø130mm circular plate and a maximum load capacity of ±3kg. AC adapter included.

TURN Ø130	QTY	N.W	G.W	C.B.M	SIZE
Packing	1	0.4kg	0.5kg	0.0025	150x70x240mm
10.518		Ø130x57mm			

TURNTABLE ±3kg | Ø130mm



TURNTABLE DETAILS



INFORMATION

*mm

This electric turntable features a Ø120mm plate and a maximum load capacity of ±2.5kg. It also features interior lighting with 4 LEDs (included). It works with batteries or directly plugged in (turntable function only works plugged in). Ideal for product display in places such as shop windows, showcases, perfumeries, stores, supermarkets or museums.

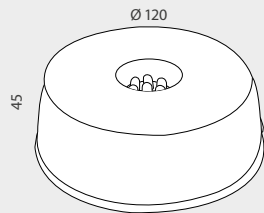

B.TURN 2KG Ø120	QTY	N.W	G.W	C.B.M	SIZE
Packing	1	0.4kg	0.45kg	0.0013	127x55x197mm
10.456					Ø120x45mm

BATTERY TURNTABLE

±2.5kg | Ø120mm



TURNTABLE DETAILS

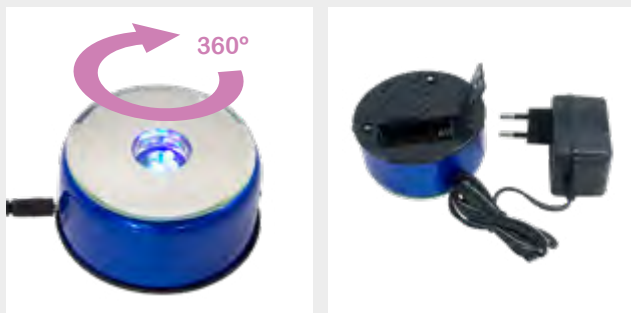



INFORMATION

*mm

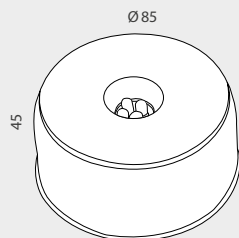
This electric turntable features a Ø85mm plate and a maximum load capacity of ±2kg. It also features interior lighting with 4 LEDs (included). It works directly plugged in or with batteries. Two colors available. Ideal for product display in places such as shop windows, showcases, perfumeries, stores, supermarkets or museums.



B.TURN 2KG Ø85	QTY	N.W	G.W	C.B.M	SIZE
Packing	1	0.3kg	0.35kg	0.002	125x75x190mm
10.407	 				Ø85x45mm

BATTERY TURNTABLE

±2kg | Ø85mm

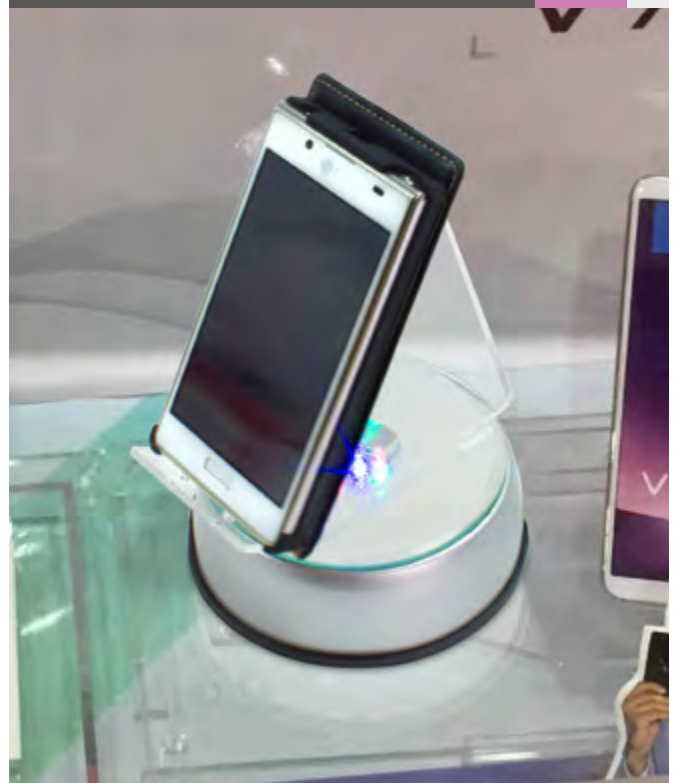

TURNTABLES Turntables

*mm



This electric turntable has a Ø85mm top plate and a maximum loading capacity of ±200g. It works with 1 AA battery (not included). Ideal for cordless exhibition of lightweight products.

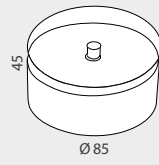

B.TURNTABLE	QTY	N.W	G.W	C.B.M	SIZE
Packing	1	0.12kg	0.15kg	0.0001	95x89x125mm
10.406		Ø85x45mm			

BATTERY TURNTABLE

±200g | Ø85mm



*mm



This solar powered turntable features a loading capacity of ±200g. It works with sunlight or indoor bright light. Ideal for cordless exhibition of lightweight products.



S.TURNTABLE	QTY	N.W	G.W	C.B.M	SIZE
Packing	1	0.08kg	0.1kg	0.0004	85x45x115mm
10.064		112x80x43mm			

SOLAR TURNTABLE

±200g



*mm



This solar powered pendulum display has a loading capacity of ±5g. It works with sunlight or indoor bright light. Ideal for cordless exhibition of lightweight products.



S.PENDULUM	QTY	N.W	G.W	C.B.M	SIZE
Packing	1	0.04kg	0.05kg	0.0002	55x30x105mm
10.358		100x50x30mm			

SOLAR PENDULUM DISPLAY

±5g



*mm



This battery powered pendulum display features a maximum loading capacity of ±14g. It works with 2 AA batteries (not included). Ideal for cordless exhibition of lightweight products.

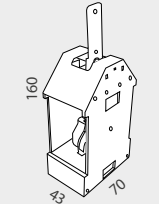

B.PENDULUM	QTY	N.W	G.W	C.B.M	SIZE
Packing	1	0.11kg	0.14kg	0.0006	75x50x165mm
10.063		160x70x43mm			

BATTERY PENDULUM DISPLAY











±14g















PIECES DETAIL *mm



"L" SHAPE *mm

"L" SHAPE	COLOR		
15.182		x4 	
15.183		x4 	
15.184		x4 	
15.185		x4 	
15.186		x4 	

"T" SHAPE *mm

"T" SHAPE	COLOR		
15.187		x4 	
15.188		x4 	
15.189		x4 	
15.190		x4 	
15.191		x4 	

"X" SHAPE *mm

"X" SHAPE	COLOR		
15.192		x4 	
15.193		x4 	
15.194		x4 	
15.195		x4 	
15.196		x4 	

CUBE SYSTEM



STAND DETAILS



INFORMATION

This transparent Stand is made of 3mm thickness acrylic. So it is ideal for displaying books, Dvd, videogames, etc... It is an excellent addition to book stores, malls, jewelry, sport stores or personal collection. 2 size models of Book Stand are available.

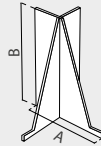

BOOK STAND	SIZE AxB	THICKNESS		
50.377	135x200mm	3mm	x5	
50.378	115x150mm	3mm	x5	

ACRYLIC BOOK STAND



STAND DETAILS



* mm

This stand for brochures is made of 3mm thickness acrylic and features 2 sizes available. This Brochure Stand is great for the exhibition of books, pamphlets or flyers...

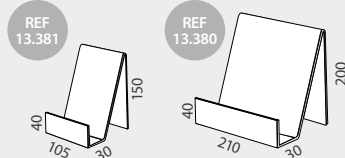

BROCHURE S.	SIZE	THICKNESS		
13.380	210x200x40mm	3mm	x5	
13.381	105x150x40mm	3mm	x5	

ACRYLIC LITERATURE STAND

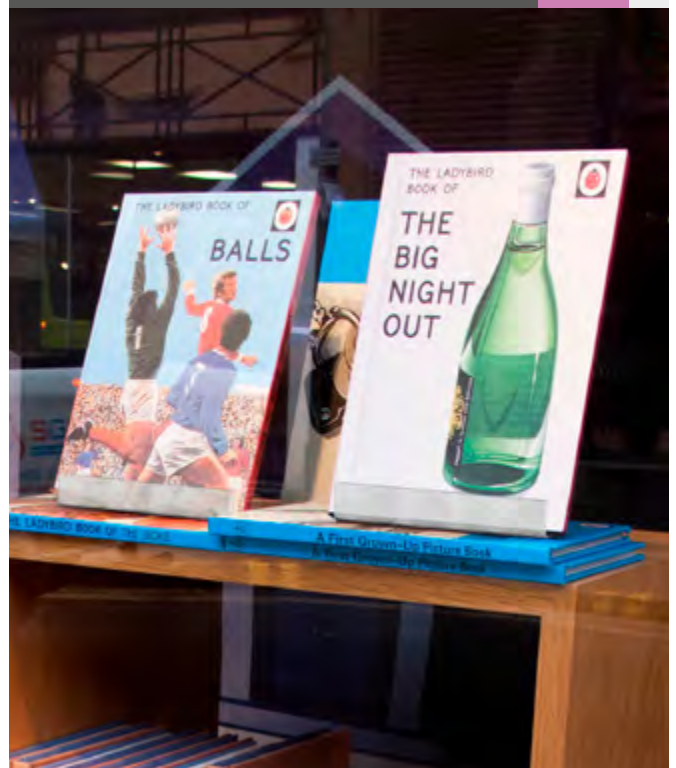



STAND DETAILS

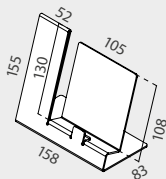

INFORMATION

This transparent stand for phones or pad/tablets is made of 2mm thickness acrylic and features a graphic holder (140x50mm) ideal for displaying the information of the device. This Phone/Pad Stand is great for malls and electronics or telephone stores.



PAD/PHONE S.	QTY	N.W	G.W	C.B.M	SIZE	
Packing	1	0.19kg	0.39kg	0.0086	320x235x115 mm	Thickness
13.562		Label Size: 140x50mm		x2		2mm

ACRYLIC PAD/PHONE STAND



STAND DETAILS



acrylic

* mm

This Monitor stand is made of 10mm thickness acrylic and features a flat surface of 547x251mm. Ideal to keep the worktable tidy and get an additional desk for the keyboard or the computer.

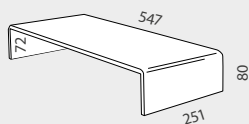

MONITOR S.	SIZE	THICKNESS	
50.380	547x251x80mm	10mm	x1 

ACRYLIC MONITOR STAND



STAND DETAILS



acrylic

* mm

This stand is made of 3mm thickness acrylic. The "U" stand is ideal for displaying some smaller products at different levels. It is an excellent addition to any retail store or for a personal collection.

REF 50.308

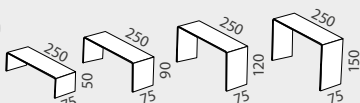

REF 50.309

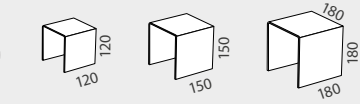

"U" SHAPED	SIZE	THICKNESS	
50.308	250x150x75mm	3mm	Set of 4

"U" SHAPED	SIZE	THICKNESS	
50.309	180x180x180mm	3mm	Set of 3

ACRYLIC "U" STAND



STAND DETAILS

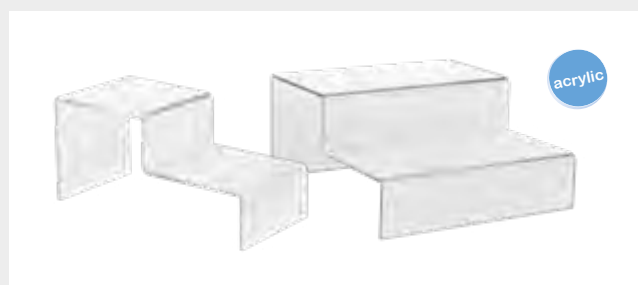

*mm

REF
50.306

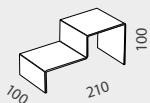

REF
50.307

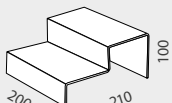

INFORMATION

This stand is made of 3mm thickness acrylic. So it is ideal for displaying some smaller promotional products at different levels, so it is an excellent addition to any retail store or personal collection for the exhibition of products.

2 STEPS	SIZE	THICKNESS	
50.306	100x100x210mm	3mm	x5
2 STEPS	SIZE	THICKNESS	
50.307	200x100x210mm	3mm	x5

ACRYLIC 2 STEPS STAND



STAND DETAILS



*mm

REF
50.304

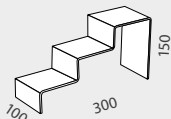

REF
50.305

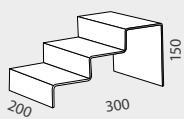

INFORMATION

This stand is made of 3mm thickness acrylic. So it is ideal for displaying some smaller promotional products at different levels, so it is an excellent addition to any retail store or personal collection. 2 sizes of display available.

3 STEPS	SIZE	THICKNESS	
50.304	100x150x300mm	3mm	x5
3 STEPS	SIZE	THICKNESS	
50.305	200x150x300mm	3mm	x5

ACRYLIC 3 STEPS STAND



STAND DETAILS



INFORMATION

* mm

This stand is made of 3mm thickness acrylic. The Podium stand is ideal for displaying some smaller products at different levels. It is an excellent addition to any retail store or for a personal collection.

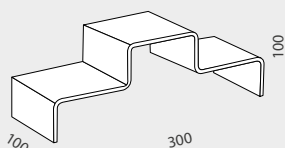

PODIUM	SIZE	THICKNESS	
50.303	100x100x300mm	3mm	x5 

ACRYLIC PODIUM STAND



STAND DETAILS



INFORMATION

* mm

This stand is made of 3mm thickness acrylic. The circular stand is ideal for displaying some smaller promotional products at different levels. An excellent addition to any retail store or personal collection. Sets of 4 pieces.

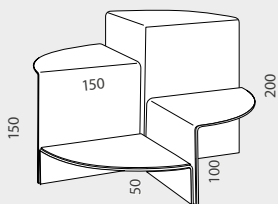

CIRCULAR S.	SIZE	THICKNESS	
50.334	Ø 300x200mm	3mm	Set of 4

ACRYLIC CIRCULAR STAND





STAND DETAILS



INFORMATION

* mm

This Pedestal is made of 3mm thick acrylic. It is an excellent addition to any retail store or personal collection. With 2 sizes available.

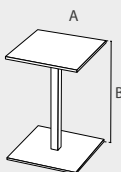

PEDESTAL	SIZE AxB	THICKNESS		
50.310	100x150mm	3mm	x5	
50.311	100x100mm	3mm	x5	

ACRYLIC PEDESTAL STAND



STAND DETAILS

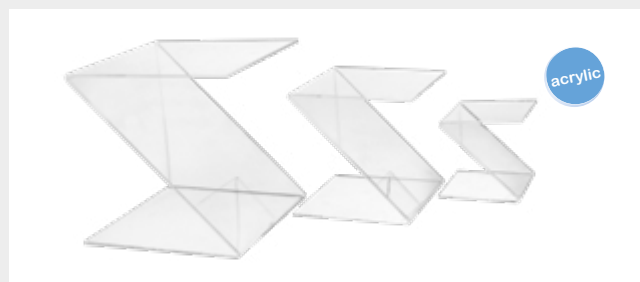

DIMENSIONS

*mm

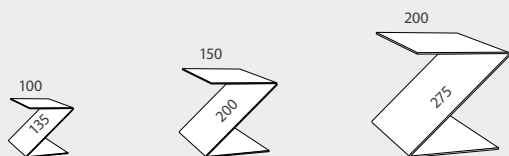

INFORMATION

This stand is made of 3mm thickness acrylic. The "Z" stand is ideal for displaying some smaller promotional products at different levels. An excellent addition to any retail store or personal collection. Sets of 3 pieces.

"Z" SHAPED	EXTERNAL SIZE SET	THICKNESS		
50.335	200x200x200mm	3mm	Set of 3	

ACRYLIC "Z" STAND





STAND DETAILS

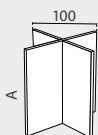

INFORMATION

This stand is made of 2mm or 3mm thickness acrylic (depending on model). So it is ideal for displaying some smaller promotional products at different levels, so it is an excellent addition to any retail store or personal collection. There are 4 sizes of "X" Stand available.



"X" SHAPED	SIZE	THICKNESS		
50.373	100x100xA25mm	2mm	x5	
50.372	100x100xA75mm	3mm	x5	
50.371	100x100xA100mm	3mm	x5	
50.370	100x100xA150mm	3mm	x5	

ACRYLIC "X" STAND



STAND DETAILS

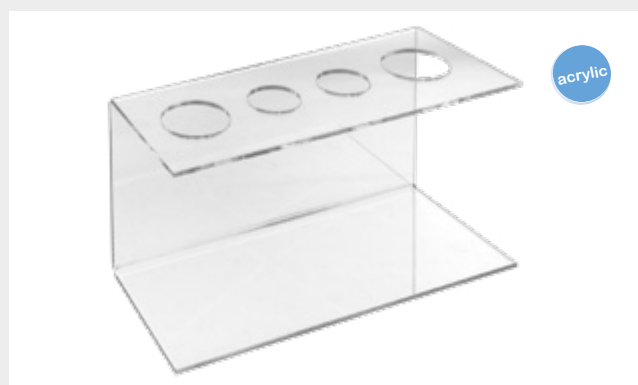

INFORMATION

* mm

This Podium is made of 3mm thickness acrylic. It is ideal for displaying ice cream cones or promotional items, so it is an excellent addition to any ice cream shop or personal collection.

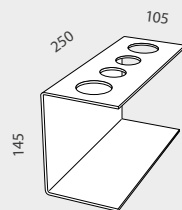

I.C. STAND	SIZE	THICKNESS		
50.336	250x145x105mm	3mm	x5	

ACRYLIC ICECREAM STAND



STAND DETAILS

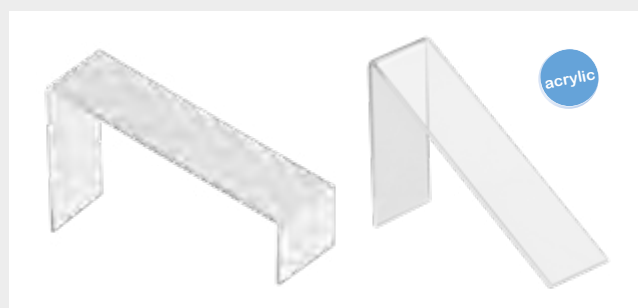

DIMENSIONS

* mm

REF 50.323

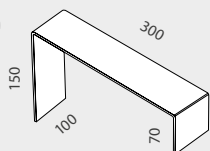

REF 50.322

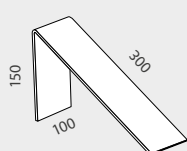

STAND DETAILS



DIMENSIONS

* mm

REF 50.300

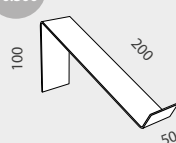

REF 50.302

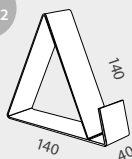

REF 50.301

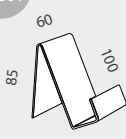

INFORMATION

This transparent Glorifier Stand is made of 2mm thickness acrylic. It is ideal for displaying smaller products, such as shoes, books, Dvd, videogames, etc... It is an excellent addition to book stores, malls, jewelry, sport stores or personal collection. Several angles and 5 models of Easel Stand are available.

GLORIFIER	SIZE	THICKNESS		
50.301	100x60x85mm	2mm	x10	
50.302	140x40x140mm	2mm	x6	
50.300	200x50x100mm	2mm	x10	
50.322	300x100x150mm	2mm	x10	
50.323	300x100x150mm	2mm	x10	

ACRYLIC GLORIFIER STAND



STAND DETAILS

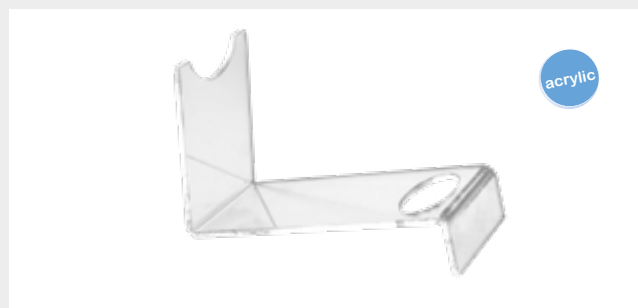

INFORMATION

* mm

This Bottle Stand is made of 5mm thickness acrylic. It is transparent and 220mm length and it is ideal for displaying bottles or cilindric items, so this acrylic stand is an excellent addition to any supermarket, wine store, retail store or just for a personal display collection.

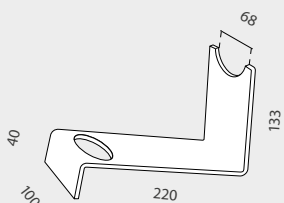

BOTTLES	SIZE	THICKNESS	
50.332	100x133x220mm	5mm	x5

ACRYLIC BOTTLE STAND



STAND DETAILS



INFORMATION

* mm

This transparent "Steps" Stand is made of 3mm thickness acrylic. It is ideal for displaying small objects, such as cans. It is an excellent addition to retail stores or markets.

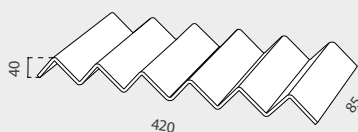

MOUNTAIN S.	SIZE	THICKNESS	
50.337	420x85x40mm	3mm	x5

ACRYLIC STEPS STAND



STAND DETAILS

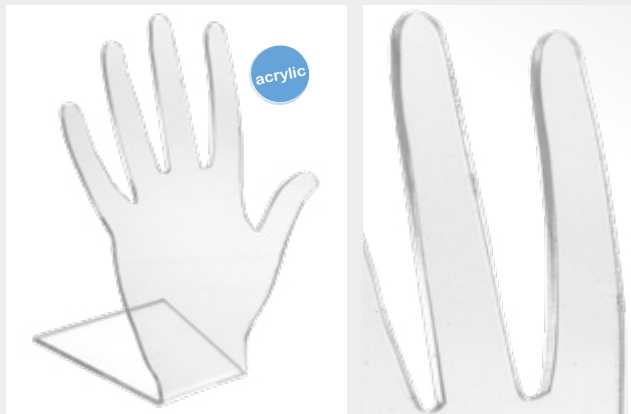

acrylic

INFORMATION

* mm

This display features a transparent hand shape and it is made of 3mm thickness acrylic. It is suitable for displaying rings or gloves. Ideal for being used on window shops.



HAND	SIZE	THICKNESS	
50.326	195x140x103mm	3mm	x5

ACRYLIC HAND STAND



STAND DETAILS



acrylic

INFORMATION

* mm

This transparent stand is made of 3mm thickness acrylic. It is ideal for displaying bracelets or jewelry. Ideal for being used on window shops and it is an excellent addition to any retail store or just for personal collection.

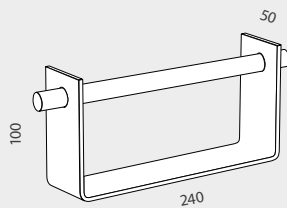

BRACELET S.	SIZE	THICKNESS	
50.315	240x100x50mm	3mm	x1

ACRYLIC BRACELET STAND



STAND DETAILS



INFORMATION

* mm

This transparent display features a "Neck-bust" shape and it is made of 3mm thickness acrylic. This display is suitable for showing necklaces or pendants. Ideal for displaying on window shops.

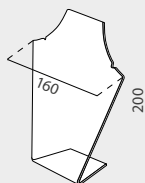

NECKLACE S.	SIZE	THICKNESS	
50.312	200x160mm	3mm	x5

ACRYLIC NECKLACE STAND



STAND DETAILS

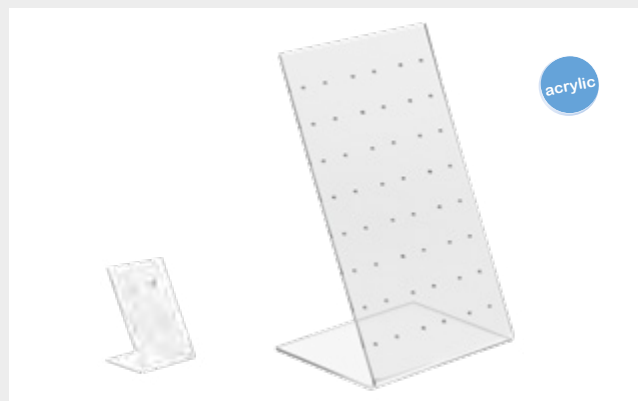

INFORMATION

* mm

This transparent display features an "L" shape and it is made of 3mm thickness acrylic. Suitable for displaying earrings. Ideal for being used on window shops.

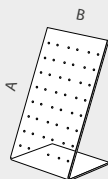

EARRINGS S.	SIZE AxB	THICKNESS	
50.316	220x120mm	3mm	x5
50.317	60x50mm	3mm	x5

ACRYLIC EARRING STAND



STAND DETAILS

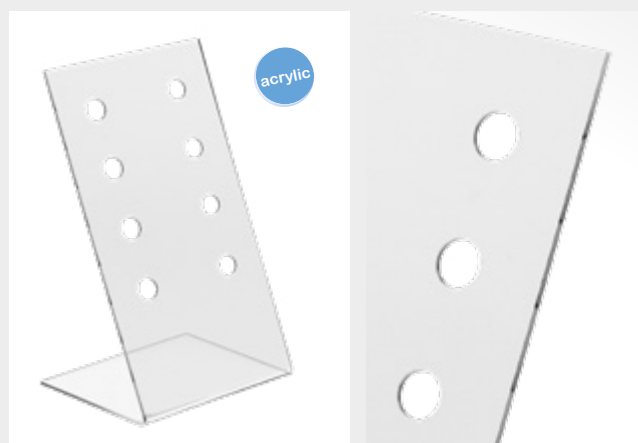

INFORMATION

* mm

This display features an "L" shape suitable for show glasses. Ideal for displaying on window shops.

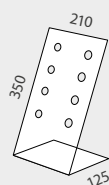

GLASSES S.	SIZE	THICKNESS	
50.324	350x210x125mm	3mm	x5 

ACRYLIC GLASSES STAND



STAND DETAILS





INFORMATION

* mm

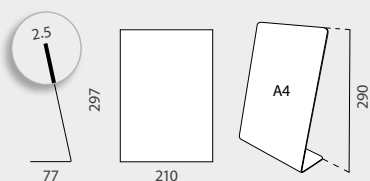
This "L" shaped mirror stand features an A4 format mirror with 2.5mm thickness, which can be labelled with logos. This stand is ideal for being used in optical stores, in jeweller's, at hairdresser or wherever the customer can get a unique and custom last impression.



"L" MIRROR	QTY	N.W	G.W	C.B.M	SIZE
Packing	1	0.98kg	1.39kg	0.0158	365x160x270 mm
13.573					x4 

"L" A4 PORTRAIT MIRROR STAND



DISPLAY DETAILS

*mm



INFORMATION

This stand feature 3 hooks for hanging or exhibiting handbags. Its height of 1 m makes it suitable for both handbags and shoulder bags. The stylish black colour finish, making it ideal for any restaurant or retail store.

HANDBAG STAND	QTY	N.W	G.W	C.B.M	SIZE	
Pole	1	0.85kg	1.15kg	0.0182	1045x140x125mm	
Base	1	2.85kg	3.01kg	0.0024	310x310x25mm	
13.848	Size base: Ø300mm		Height: 1010mm			

HANDBAG STAND



STAND DETAILS

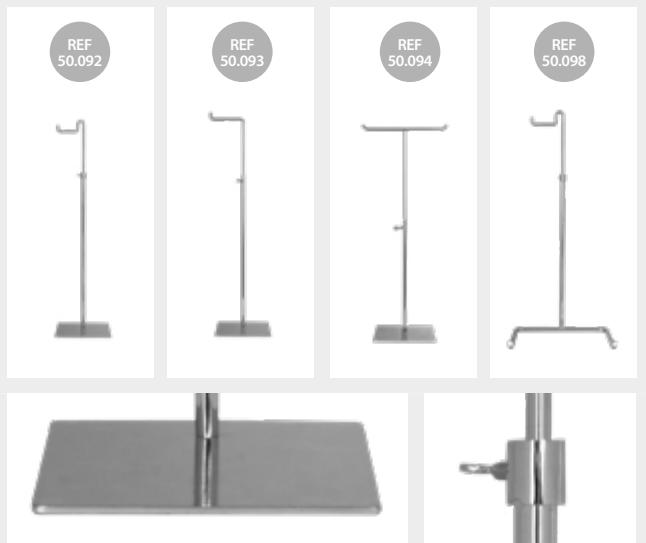

DIMENSIONS

*mm

These Handbag Displays Stand feature single or double hooks for using on countertops. With adjustable height from 273 to 580mm (depending on model).

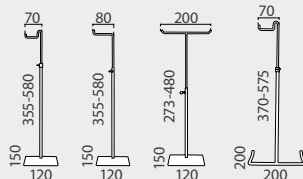

HANDBAG	SIZE BASE	HEIGHT	
50.092	120x150mm	355-580mm	x5 
50.093	120x150mm	355-580mm	x5 
50.094	120x150mm	273-480mm	x5 
50.098	200x200mm	370-575mm	x5 

HANDBAG DISPLAY





Cardboard

11

Complete range of cardboard displays and accessories which provide an integral solution for the exhibition at stores or business presentations.

- 458 CARDBOARD COUNTER
- 461 CARDBOARD STOOL
- 462 CARDBOARD LECTERN
- 463 CARDBOARD DISPLAY
- 469 CARDBOARD COMPLEMENTS
- 471 BROCHURE CARDBOARD HOLDER
- 474 CARDBOARD EASELS
- 476 CARDBOARD ACCESSORIES



COUNTER DETAILS



INFORMATION

*mm

Praga Counter is very lightweight and exhibitors can quickly assemble it in less than 5 minutes (no tools required). Fully removable. This counter has a header of 760x300mm (with PVC bars) for displaying company logos or graphs. Each counter that comes with a header is excellent for tradeshows, points of sale, promotional acts in malls or as a display to advertise your business in any exhibition or tradeshow.

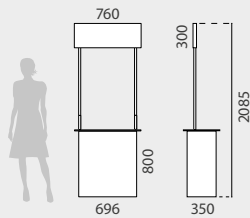

PRAGA	QTY	N.W	G.W	C.B.M	SIZE
Packing	1	3.05kg	3.9kg	0.0443	920x45x1070mm
10.730		696x350x2085mm			

PRAGA COUNTER



COUNTER DETAILS



INFORMATION

*mm

This counter is assembled in less than 5 minutes. It has an inner space at the bottom of the counter, so the extra brochures, business cards and pencils can be stored out of sight so your exhibition always appears clean and organized. Ideal for points of sale, promotional acts in malls or as a counter to advertise your business in for any exhibition or tradeshow.

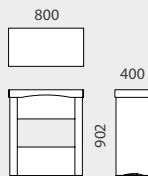

INZA	QTY	N.W	G.W	C.B.M	SIZE
Packing	1	1.8kg	2.8kg	0.0569	1055x980x55mm
13.750		800x400x902mm			

INZA COUNTER



DESK DETAILS



INFORMATION

*mm

This Counter Desk features the white color with the corrugated natural cardboard for a stylish finish. Also has a strong and stable design with an inner shelf for storing, also it has front-back/sides spaces for placing your own logo or graphic. Ideal for being used as a meeting point at exhibition acts, at events to promote your business or just as a side table at your home.

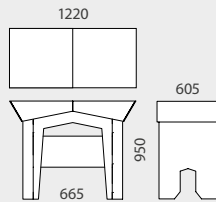

CALI	QTY	N.W	G.W	C.B.M	SIZE
Packing	1	5.25kg	6.3kg	0.0998	950x75x1400mm
13.728		1220x605x950mm			

CALI DESK

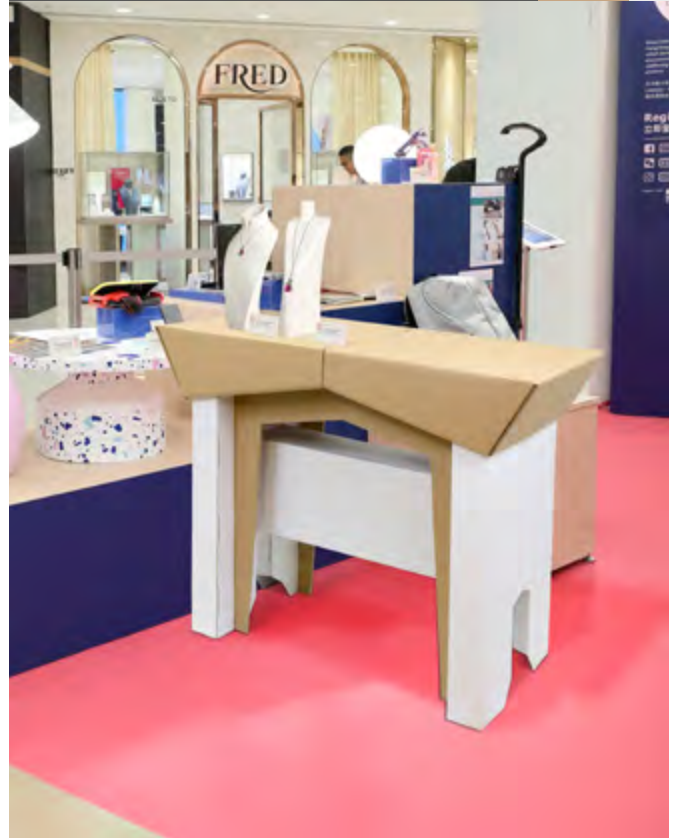

COUNTER DETAILS



INFORMATION

*mm

This Counter features the white color with the corrugated natural cardboard for a stylish finish. Miami is assembled in seconds. It has an inner space at the bottom of the counter, so business cards and pencils can be stored out of sight so your exhibition always appears clean and organized. Ideal for points of sale, promotions in malls or any tradeshow.

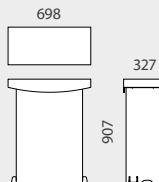

MIAMI	QTY	N.W	G.W	C.B.M	SIZE
Packing	2	3.85kg	5.10kg	0.066	1260x1045x50mm
13.749		698x327x907mm		x2 	

MIAMI COUNTER



COUNTER DETAILS



DIMENSIONS

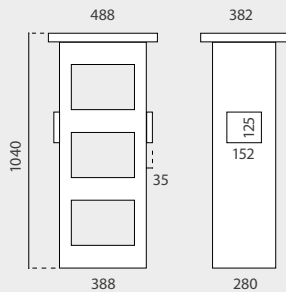

TEMPLATE

*mm

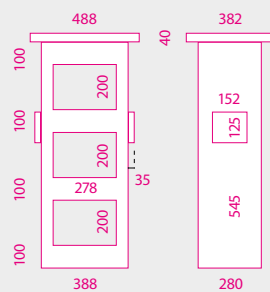

INFORMATION

This Exhibitor Counter is easy to assemble and lightweight. It is made of 5mm cardboard sheets thickness. It features 3 interior shelves and 1 table-top which allow customers to easily access product accessories from either side of the corrugated counter. Also, it has 2 brochure holders for promotional documents (left or right placed by the customer). The London Counter ships flat and is easy to assemble with the guidance of the provided instructions. Ideal for being used as an exhibitor or as a counter at points of sale, for tradeshow events, stores or for any temporary promotion.

LONDON	QTY	N.W	G.W	C.B.M	SIZE
Packing	1	1.35kg	2kg	0.0266	425x60x1045mm
10.733					488x382x1040mm

LONDON



STOOL DETAILS

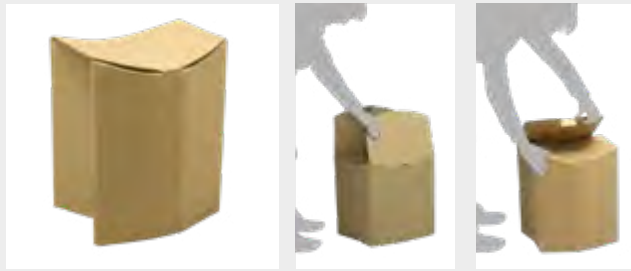

INFORMATION

*mm

This lightweight oval cardboard stool is assembled in seconds and comes in Kraft color. Also has a strong and stable design. Once folded it can be stored in a minimum space so it is ideal to be added to your meeting point at trade shows, eco-stores, events or for enhancing your office or home spaces.

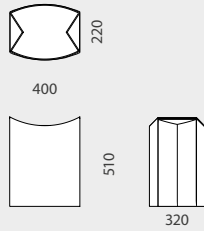

OVAL	QTY	N.W	G.W	C.B.M	SIZE
Packing	4	2.4kg	2.9kg	0.0514	705x90x810mm
13.735	320x400x510mm				x4 

OVAL STOOL



STOOL DETAILS



INFORMATION

*mm

This lightweight Kraft color stool is assembled in seconds. With great resistance thanks to its hexagonal base. Once folded it can be stored in a minimum space. Ideal for meeting points at trade shows, eco-stores or for enhancing your office or home spaces. There are 2 heights available.

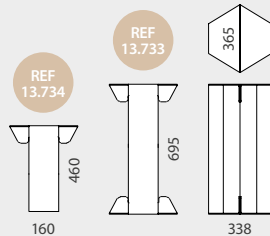

HEX LOW	QTY	N.W	G.W	C.B.M	SIZE
Packing	4	1.6kg	1.93kg	0.0371	535x90x770mm
13.734	338x460x365mm				x4 
HEX HIGH	QTY	N.W	G.W	C.B.M	SIZE
Packing	4	2.8kg	3.4kg	0.0612	535x90x1270mm
13.733	338x695x365mm				x4 

HEX STOOL



STAND DETAILS



INFORMATION

*mm

Nasau is composed of a single pre-cut and folded corrugated cardboard sheet and a top header. Assembled, it forms a column newspaper rack, the capital making the Lectern. A logo or a text can be printed on the top header. A tab on the lectern can be folded up to hold open books. Ideal for leaflets, magazines, newspapers stores, exhibitions or for meeting points at professional shows and exhibitions.

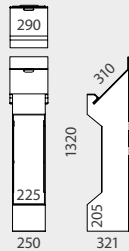

NASAU	QTY	N.W	G.W	C.B.M	SIZE
Packing	2	2kg	3kg	0.051	1225x1040x40mm
13.747	290x321x1320mm			x2	

NASAU STAND



DESK DETAILS



INFORMATION

*mm

This cardboard Kraft color lectern reading desk features a large inclined surface ideal for displaying large documents and a microphone holder with cable gland at the bottom for the speaker. Also, it has an extra shelf an inner space at the bottom for the extra brochures, business cards or pencils. Ideal for storing newspapers, leaflets, magazines at media events or for meeting points at trade fairs and exhibitions.

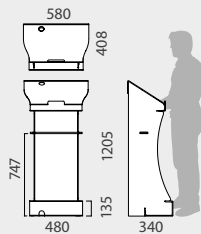

BERMUDA	QTY	N.W	G.W	C.B.M	SIZE
Packing	1	1.7kg	2.7kg	0.051	1225x1040x40mm
13.746	580x340x1205mm				

BERMUDA DESK



DISPLAY DETAILS



DIMENSIONS

TEMPLATE

*mm

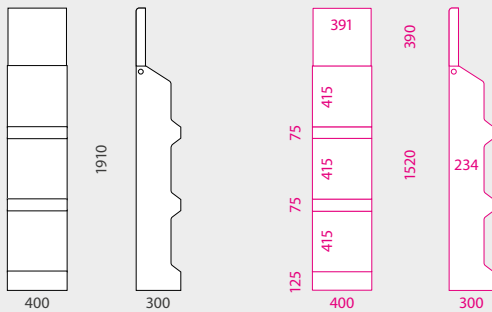

INFORMATION

The Viena Dispenser is easy to assemble and lightweight (1.1 kg). It is made of 3mm cardboard sheets thickness. It features 3 shelves which allow customers to easily access product accessories. Also, it has 1 upper header which allows to be customized. The Viena Counter ships flat and is easy to assemble with the guidance of the provided instructions. Ideal for being used as an exhibitor at points of sale, retail, stores, promotional acts in supermarkets, as a display to advertise your business in any event tradeshow or for any temporary promotion.

VIENA	QTY	N.W	G.W	C.B.M	SIZE
Packing	1	1.1kg	1.7kg	0.0222	720x20x1540mm
10.734					400x300x1910mm

VIENA



STAND DETAILS



DIMENSIONS

TEMPLATE

*mm

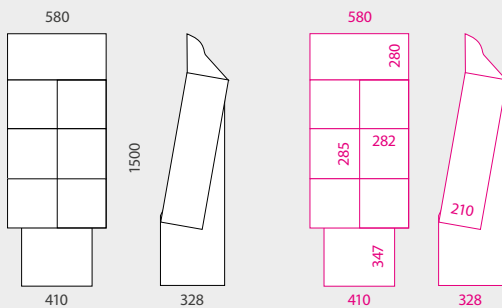

INFORMATION

Oslo is a very fast to assemble cardboard display with two white coated sides. Also, it is lightweight (2.8 kg). Includes 5mm thick cardboard upper header, 6 shelves displays (1.5mm cardboard's thickness) and a 5mm thick cardboard base. Ideal for using at points of sale, promotional acts in supermarkets or as a display to advertise your business in any event or any exhibition.

OSLO	QTY	N.W	G.W	C.B.M	SIZE
Packing	1	2.8kg	3.9kg	0.2196	820x255x1050mm
10.731					580x328x1500mm

OSLO



STAND DETAILS



DIMENSIONS

TEMPLATE

*mm

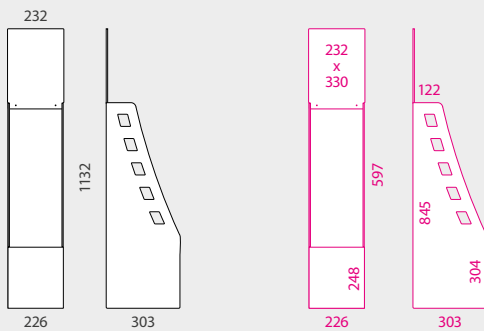

INFORMATION

This cardboard Brochure Stand is the perfect retail tool for magazine storage and display. Caribe Stand is designed with a shelf support of 219x302mm which is reinforced with a cross-piece for holding a variety of publications. This cardboard magazine holder, also known as a corrugated cardboard literature holder, is perfect for supermarkets, pharmacies, bookstores and more. Customize the Top Header to draw attention to your best selling magazines or literature. This cardboard magazine holder is an affordable alternative to pricier slatwall magazine holder displays.

CARIBE	QTY	N.W	G.W	C.B.M	SIZE
Packing	2	2.8kg	3.67kg	0.0238	900x660x40mm
13.745	226x303x1132mm		x2 		

CARIBE



DUMPBIN DETAIL

DIMENSIONS

*mm

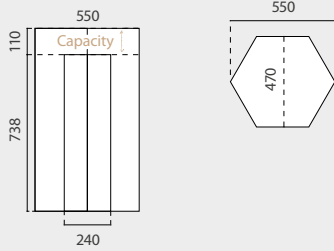

INFORMATION

This white coated cardboard dumpbin is very lightweight (only 1.35kg) and fast to set-up. It's ideal for getting the attention of the customers. Accra's design bets more on product display, allowing a faster access and business output.

ACCRA	QTY	N.W	G.W	C.B.M	SIZE
Packing	1	1.35kg	2kg	0.018	830x25x910mm
13.466					550x470x848mm

ACCRA



DUMPBIN DETAIL

DIMENSIONS

*mm

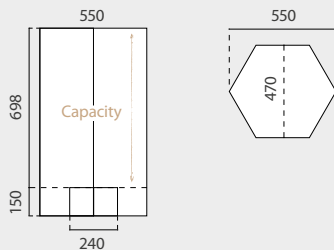

INFORMATION

This white coated cardboard dumpbin is lightweight (only 1.35 kg), also it is fast to assemble. It's ideal for getting the attention of the customers. Lagos' design, thanks to its great capacity, bet more for the storage of the products.

LAGOS	QTY	N.W	G.W	C.B.M	SIZE
Packing	1	1.35kg	2kg	0.018	830x25x910mm
13.467					550x470x848mm

LAGOS



DUMPBIN DETAIL

DIMENSIONS

*mm

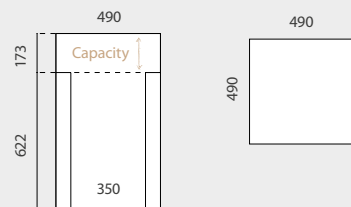

INFORMATION

This white coated cardboard dumpbin is very light weight (only 1.15 kg) and also it is fast to set-up. It's ideal for getting attention of the customers. Berna's design bets more on product display, allowing a faster access and business output.

BERNA	QTY	N.W	G.W	C.B.M	SIZE
Packing	1	1.15kg	1.8kg	0.0255	850x30x1000mm
10.732					490x490x795mm

BERNA



* the filmstrip on Berna (10.732) is available on Chapter 08 Signage, but not included in its price.

PODIUM DETAILS



PODIUM SET UP



INFORMATION

DIMENSIONS

*mm

This cardboard podium stand has a white finish so it is ideal for customizing with your own graphics. It is very lightweight and also very easy to set-up. Its folding design allows to generate a stable platform with a perfectly sealed appearance for promoting. So it's perfect as Eye-catching advertisement for products promoting at points of sale, retail stores, malls, shopping markets or as an exhibitor display to get the attention of the customers.

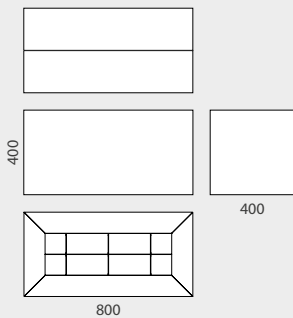

PODIUM	QTY	N.W	G.W	C.B.M	SIZE
Packing	1	2.15kg	3.15kg	0.051	1225x1040x40mm
13.729		400x800x400mm			

PROMOTIONAL PODIUM STAND



PHOTOCALL DETAILS



INFORMATION

*mm

The white finish Fasteasy photocall is ideal for customizing with your own graphics. Inexpensive and durable, this stand features the possibility of joining 2 or more photocalls to create large advertising spaces. Also, we supply this cardboard photocall with easel and plastic screws. It is lightweight, making it easy to transport and also easy to fold for storing.

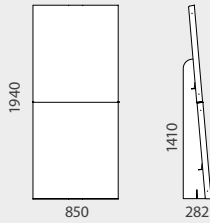

PHOTOCALL	QTY	N.W	G.W	C.B.M	SIZE
Packing	2	3.3kg	4.3kg	0.0569	1055x980x55mm
13.727	850x282x1940mm				x2 

FASTEASY PHOTOCALL



SIDEWALK DETAILS



INFORMATION

*mm

The Neiva A-Board has a white finish so it is ideal for customizing with your own offers or graphics. It's assembled in seconds. Features a folding design which allows an easy storage. Neiva is perfect as Eye-catching advertisement for products promotion at point of sale, malls, retail stores, shopping markets or as an exhibitor display to get the attention from the customers.

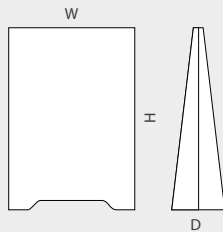

NEIVA	QTY	N.W	G.W	C.B.M	Size (WxHxD)
Packing	2	1.74kg	2.74kg	0.0569	1055x980x55mm
		Visual (X-Y)	External (WxHxD)		
Product		540x780	540x770x310		
13.748	Graphic Size: 1158x600mm				x2 

NEIVA SIDEWALK



CORNER DETAILS

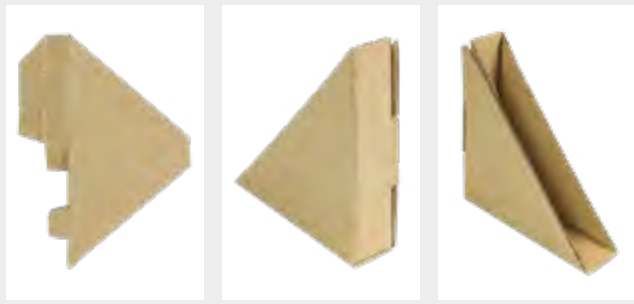

INFORMATION

*mm

This corrugated cardboard corner protectors are assembled in seconds and come in Kraft color. Also has a strong and tough design. They are a great solution for the protection and packaging of frame moldings. So they are ideal for safe transporting or storing of pictures.

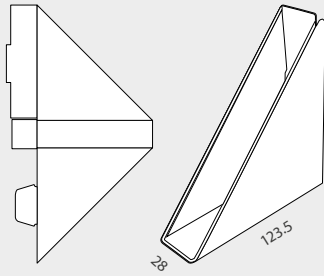

PROTECTORS	QTY	N.W	G.W	C.B.M	SIZE
Packing	50	1.25kg	1.50kg	0.0123	560x490x45mm
13.732	123.5x28x123.5mm			x50	

CORRUGATED CORNER PROTECTORS



BIN DETAILS



INFORMATION

*mm

This Bin is made from durable corrugated cardboard. Our storage bins do not require staples or tape to assemble as they have an efficient one-piece self-locking construction. Our kraft and white corrugated bin boxes include a write-on space for easy labelling and identification of the stored items. These bins are stored and shipped flat. Perfect for enhancing your office or home space.

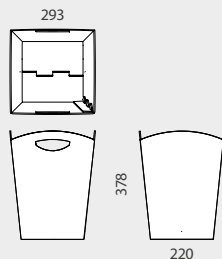

BIN	QTY	N.W	G.W	C.B.M	SIZE
Packing	4	1.67kg	2kg	0.0371	535x90x770mm
13.751	293x293x378mm			x4	

CARDBOARD BIN



BOXES DETAILS

*mm



BOXES SET UP



DIMENSIONS

*mm

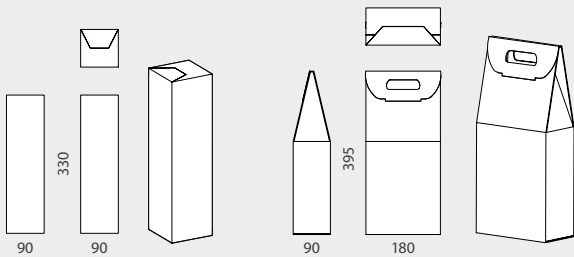

INFORMATION

These white coated bottle boxes are designed to enhance the presentation of your products by adding a little luxury to your clients' gifts. Just finish off with your own customization or a gift ribbon. This single white coated 75cl bottle box features a high quality design with upper closer, which will help you transport the bottle upright and without smashes, leaks or the base falling through. The double bottle box model, also features a high quality resisting upper handle for an easy transportation.

1 BOTTLE BOX	QTY	N.W	G.W	C.B.M	SIZE
Packing	10	1kg	1.25kg	0.123	560x490x45mm
13.731		90x330x90mm			x10 

2 BOTTLES BOX	QTY	N.W	G.W	C.B.M	SIZE
Packing	10	1kg	1.25kg	0.0123	560x490x45mm
13.730		90x395x180mm			x10 

**WINE BOTTLE
CARDBOARD BOX**



A5 HOLDER DETAILS

*mm

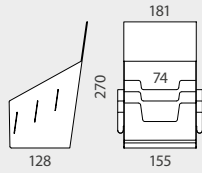

1/3 A4 HOLDER DETAILS

*mm

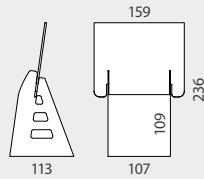

A5 HOLDER DETAILS

*mm

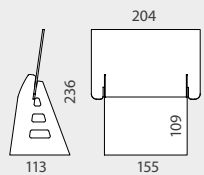

A4 HOLDER DETAILS

*mm

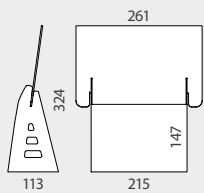



INFORMATION

These Brochure Holders are made of white coated cardboard and are ideal for being used over counter desktop for temporary promotions. The A4, A5 and 1/3 of A4 format models feature a slightly angled back design and high rear supports for a better displaying. The Triple A4 format model features 3 compartments. We provide the cardboard Holders flat, and it requires only a few simple folds to assemble it.

3x A5 D.	QTY	N.W	G.W	C.B.M	SIZE
Packing	10	0.25kg	0.40kg	0.0069	480x360x40mm
13.741	Leaflet size: A5			x10	

1/3 A4 D.	QTY	N.W	G.W	C.B.M	SIZE
Packing	10	0.25kg	0.40kg	0.0069	480x360x40mm
13.742	Leaflet size: 1/3 A4			x10	

A5 DISPENSER	QTY	N.W	G.W	C.B.M	SIZE
Packing	10	0.3kg	0.38kg	0.0069	480x360x40mm
13.744	Leaflet size: A5			x10	

A4 DISPENSER	QTY	N.W	G.W	C.B.M	SIZE
Packing	10	0.60kg	0.75kg	0.0127	655x485x40mm
13.743	Leaflet size: A4			x10	

CARDBOARD LEAFLET DISPENSER



HOLDER DETAILS



DIMENSIONS

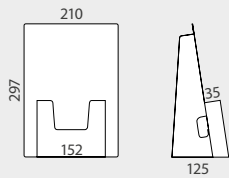

TEMPLATE

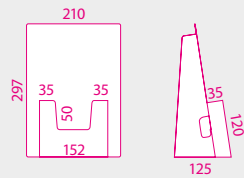

*mm

INFORMATION

Belgrado Brochure Holder is made of 1.5mm thickness white coated cardboard. With top header for customizing your presentation. High rear support and slightly angled back design allow increased visibility of the promotions.

BELGRADO	QTY	N.W	G.W	C.B.M	SIZE
Packing	5	0.33kg	0.5kg	0.0034	275x40x310mm
10.881	210x125x297mm		x5 		

BELGRADO

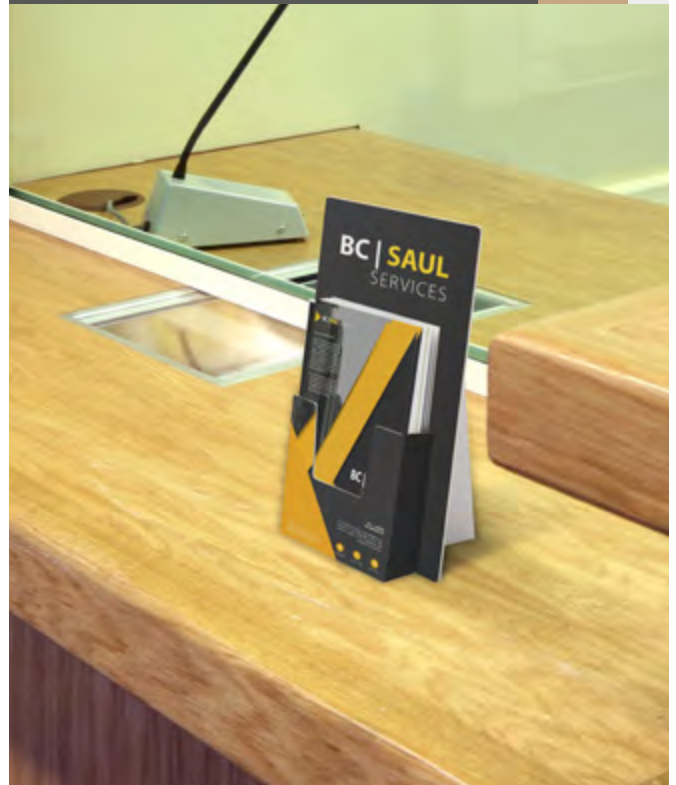

BALLOT BOX DETAILS



INFORMATION

*mm

Trieste Ballot Box is made of 2mm thickness white coated cardboard. It includes a top header for your presentations. It is ideal for promotional contests, used as suggestion box or just for voting thanks to its 2 sides brochure holders (125x35x152mm each of them).

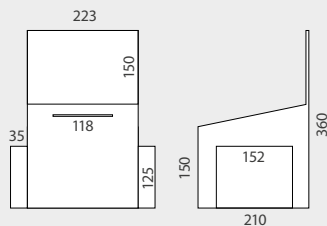

TRIESTE	QTY	N.W	G.W	C.B.M	SIZE
Packing	5	1.25kg	1.55kg	0.0143	570x500x50mm
13.080	223x210x360mm		x5 		

TRIESTE BALLOT BOX



DISPLAY DETAILS



DIMENSIONS

TEMPLATE

*mm

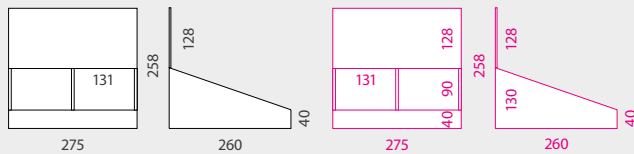

INFORMATION

Burdeos is a Lightweight and white coated display made of 1.5mm thickness cardboard. Easy and fast set up. The removable divider allows 1 or 2 spaces for exhibition. Ideal as eye-catching point of purchase presentation on any counter.

BURDEOS	QTY	N.W	G.W	C.B.M	SIZE
Packing	5	1.1kg	1.44kg	0.0123	570x500x50mm
10.868	275x260x258mm		x5 		

BURDEOS



DISPLAY DETAILS



DIMENSIONS

TEMPLATE

*mm



INFORMATION

Budapest is a lightweight and white coated display made of 1.5mm thickness cardboard. Ideal for displaying last minute add-on items, for customers to purchase as they are checking out. Hooks and printing is available but not included.

BUDAPEST	QTY	N.W	G.W	C.B.M	SIZE
Packing	5	0.525kg	0.7kg	0.0038	260x35x415mm
10.831	Graphic size: 250x350mm		x5 		

BUDAPEST



EASEL DETAILS



CARDBOARD EASELS

INFORMATION

- Lightweight
- White coated.
- Fast to assemble.
- 7 sizes available.
- Easy foldable to store.
- Easels are ideal for standing up a display.

DIMENSIONS

*mm





INFORMATION

The Easels are ideal for standing up displays and for creating wall presentations.

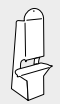

EASEL 140	QTY	N.W	G.W	C.B.M	SIZE
Packing	50	0.37kg	0.45kg	0.0029	170x85x200mm
12.085	Height: 140mm		x50 		



EASEL 275	QTY	N.W	G.W	C.B.M	SIZE
Packing	50	0.91kg	1.05kg	0.0073	250x85x340mm
12.086	Height: 275mm		x50 		



EASEL 310	QTY	N.W	G.W	C.B.M	SIZE
Packing	50	0.56kg	0.71kg	0.0056	240x65x365mm
12.115	Height: 310mm		x50 		



EASEL 470	QTY	N.W	G.W	C.B.M	SIZE
Packing	50	2kg	2.7kg	0.0074	395x310x605mm
12.444	Height: 470mm		x50 		



EASEL 680	QTY	N.W	G.W	C.B.M	SIZE
Packing	20	1.97kg	2.4kg	0.0171	565x40x760mm
12.116	Height: 680mm		x20 		



EASEL 900	QTY	N.W	G.W	C.B.M	SIZE
Packing	20	6.75kg	7.82kg	0.1131	715x280x565mm
12.445	Height: 900mm		x20 		



EASEL 1380	QTY	N.W	G.W	C.B.M	SIZE
Packing	20	10kg	11.4kg	0.1441	715x280x720mm
12.446	Height: 1380mm		x20 		

PODIUM DETAILS

*mm

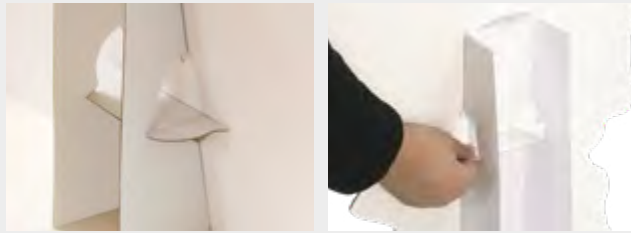
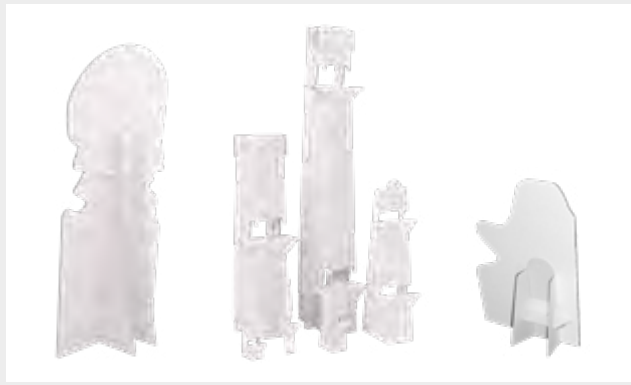

INFORMATION

The double wing cardboard easel backs adds that extra support for slightly and wider signs. They are ideal for creating stand up displays with big dimensions.

CARDBOARD EASELS



SHEETS DETAILS

*mm



INFORMATION

- Pack of 10 units.
- Lightweight sheets.
- 2 sided white coated.
- A4 and A3 sizes available.
- 1.5mm thickness cardboard.
- White sheets offer a nice clean look, also provides added durability and a pleasant white look in the workplace or home, for displaying, modelling, arts or protecting packages, easy to store.

A4 SHEETS	QTY	N.W	G.W	C.B.M	SIZE
Packing	10	0.32kg	0.4kg	0.0013	220x20x305mm
10.994		A4			x10 
A3 SHEETS	QTY	N.W	G.W	C.B.M	SIZE
Packing	10	0.65kg	0.8kg	0.0026	430x20x305mm
10.995		A3			x10 

SHEETS



FIXING SPEARS DETAILS



INFORMATION

*mm

The fixing spears are made of lightweight plastic, using it with nylon wire (not included) they are an easy solution for hanging promotional offers from ceiling. Also thanks to its design they are ideal for being used with foamboards signages.

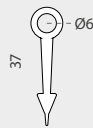

FIXING SPEARS LENGTH

12.538	37mm	x100 
--------	------	--

FIXING SPEARS



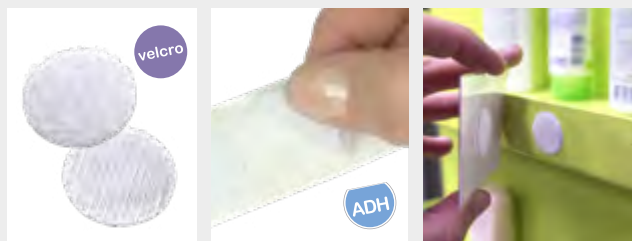

DISCS DETAILS



INFORMATION

These adhesive adjustable tape discs are easy to use and they are durable and strong. Allows an easily changing of signage position thanks to its male and female genuine VELCRO® brand sides. 3 diameters available. Ideal for being used with paper crafts, cardboard or displays.

TAPE DISCS DIAMETER

12.505	♂ 10mm	x1000 
12.506	♀ 10mm	
12.507	♂ 20mm	x1000 
12.508	♀ 20mm	
12.509	♂ 25mm	x1000 
12.510	♀ 25mm	

ADJUSTABLE TAPE DISCS



* VELCRO® is a registered trademark of Velcro BVBA. | VELCRO® est une marque déposée de Velcro Industries B.V. | VELCRO® é uma marca registrada de Velcro Industries B. V. | VELCRO® es una marca registrada de VelcroIndustries B. V.

DISPLAY DETAILS



INFORMATION

*mm

This open display features a portrait shape and 7 sizes for documents. Includes 2 adhesive strips at the back side for fixing on different surfaces. Paper slips in easily through the sides.

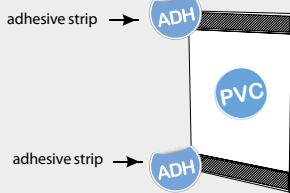

SANDWICH PORTRAIT THICKNESS

SANDWICH	PORTRAIT	THICKNESS				
13.428	A1	0.5mm	x10 			
13.429	A2	0.5mm	x10 			
13.064	A3	0.5mm	x10 			
13.065	A4	0.5mm	x10 			
13.066	A5	0.5mm	x20 			
13.067	A6	0.5mm	x20 			
13.430	A7	0.5mm	x30 			

ADHESIVE PVC POCKET



HANGER DETAILS

*mm

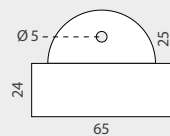

INFORMATION

Made of 0.04mm PVC and it has a front adhesive. Ideal for hanging foam board, cardboard, posters on walls, ceiling or hanging from prongs.

PVC HANGER

SIZE

12.512	65x49mm	x50 
--------	---------	---

ADHESIVE PVC HANGER



CONNECTOR DETAILS

INFORMATION

*mm

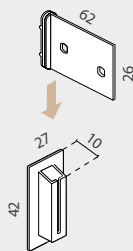

Two interlocking connector pieces for bonding into corrugated cardboard, which are designed for a solid and great supporting on shelf. Also allows an easy flat pack distribution. Ideal for the construction of cardboard displays.

C-27x42x62 PLATE SIZE BASE SIZE

12.517 62x26mm 27x42mm x100 

CARDBOARD CONNECTOR

62x26mm PLATE



CONNECTOR DETAILS

INFORMATION

*mm

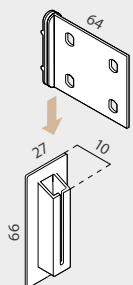

Two interlocking connector pieces for bonding into corrugated cardboard, which are designed and great supporting on shelf. Also allows an easy flat pack distribution.

C-27x66x64 PLATE SIZE BASE SIZE

12.516 64x43mm 27x66mm x100 

CARDBOARD CONNECTOR

64x43mm PLATE



CONNECTOR DETAILS

INFORMATION

*mm

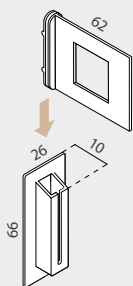

Two interlocking connector pieces for bonding into corrugated cardboard, which are designed and great supporting on shelf. Also allows an easy flat pack distribution.



C-26x66x62 PLATE SIZE BASE SIZE

12.515 62x47mm 26x66mm x100 

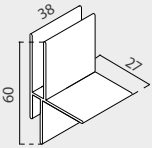

CARDBOARD CONNECTOR

62x47mm PLATE



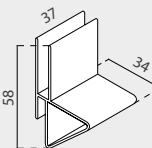

CLIP DETAIL	INFORMATION	DIMENSIONS	*mm
	Transparent PVC clip for quick and secure corrugated shelf construction by slotting into die cut holes.		
BRACKET	SIZE		
12.514	38x60x27mm	x100 	



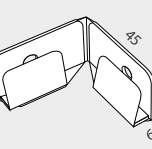

CLIP DETAIL	INFORMATION	DIMENSIONS	*mm
	Transparent and reinforced clip for quick and secure, high strength corrugated shelf construction by slotting into die cut holes.		
REINFORCED	SIZE		
12.513	37x58x34mm	x100 	



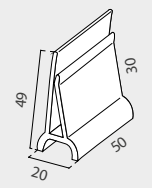

CASTER DETAIL	INFORMATION	DIMENSIONS	*mm
	Caster rises the cardboard display to avoid the contact with the ground and also enables easy moving of the cardboard display. Fast assembly with clip on bottom of cardboard display.		
SIMPLE	CORNER LENGTH		
12.286	45x45mm	x100 	



CASTER DETAIL	INFORMATION	DIMENSIONS	*mm
	This caster feet rises display from ground extending the life of usage. It enables easy moving of cardboard display. Easy assembly with clip on bottom of cardboard display.		
CLIP	HEIGHT		
12.518	49mm	x100 	

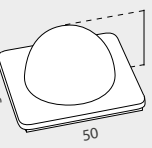

CASTER DETAIL	INFORMATION	DIMENSIONS	*mm
	This caster rises the cardboard display 23mm from the ground and protects it from damaging, featuring a 50x50mm adhesive foam. It also enables easy moving of display. Fast assembly.		
ADHESIVE	SIZE		
12.287	50x50x23mm	x100 	



CARDBOARD ACCESSORIES Rivets | Screws

INFORMATION

We provide an excellent selection of fasteners, such as plastic bolts, nuts or screws for the signage attachment and other applications.

Plastic rivet fasteners have numerous applications and come in a wide variety of styles, sizes, and configurations to accommodate different panel dimensions.

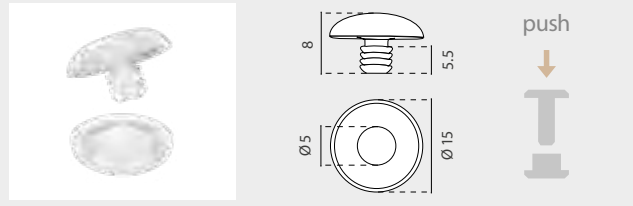

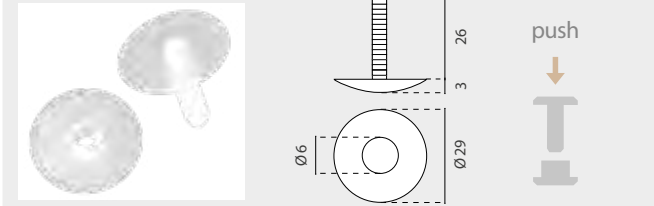

push

12.283 $\varnothing 15$ | $\varnothing 5$ mm 5.5mm x100 



push

12.285 $\varnothing 29$ | $\varnothing 6$ mm 26mm x100 

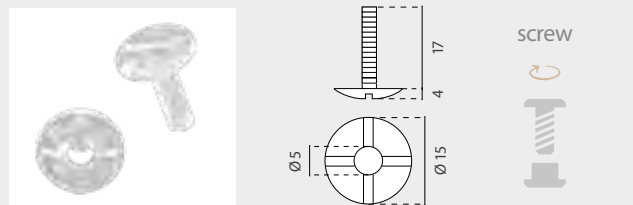

screw

12.367 $\varnothing 15$ | $\varnothing 5$ mm 17mm x100 

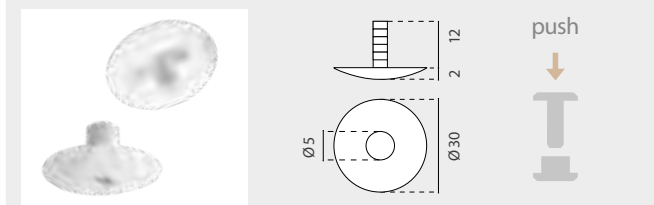

push

12.114 $\varnothing 30$ | $\varnothing 5$ mm 12mm x100 

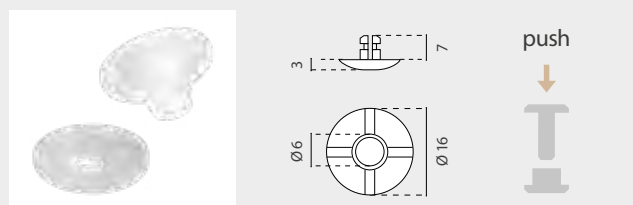

push

12.469 $\varnothing 16$ | $\varnothing 6$ mm 7mm x100 

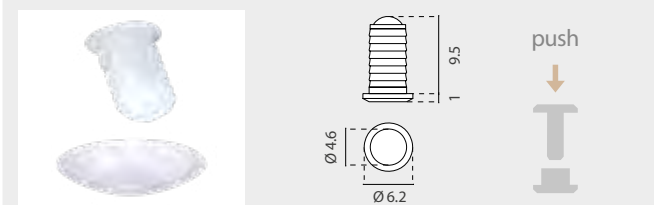



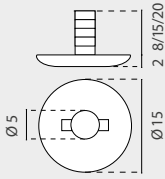

push

50.111 $\varnothing 6.2$ | $\varnothing 4.6$ mm 9.5mm x100 

CARDBOARD ACCESSORIES Rivets | Screws





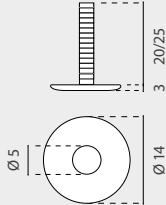

screw 

12.466	Ø 15 Ø 5mm	8mm	x100 
12.467	Ø 15 Ø 5mm	15mm	x100 
12.468	Ø 15 Ø 5mm	20mm	x100 



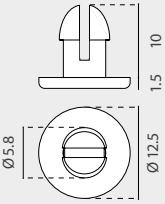

screw 

12.463	Ø 14 Ø 5mm	20mm	x100 
12.464	Ø 14 Ø 5mm	25mm	x100 



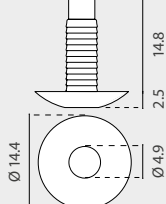

push 

12.521	Ø 12.5 Ø 5.8mm	10mm	x100 
--------	------------------	------	--



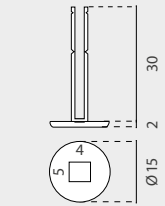

push 

50.110	Ø 14.4 Ø 4.9mm	14.8mm	x100 
--------	------------------	--------	--





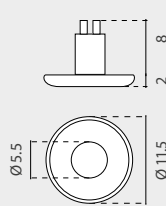

push 

12.532	Ø 15 6x5mm	30/12mm	x100 
--------	--------------	---------	--



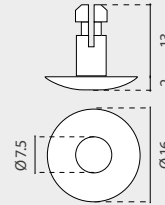

push 

12.533	Ø 11.5 Ø 5.5mm	10mm	x100 
--------	------------------	------	--



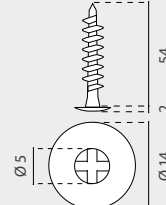

push 

12.534	Ø 16 Ø 7.5mm	15mm	x100 
--------	----------------	------	--



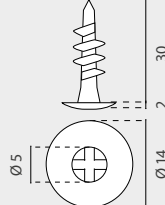

screw 

12.535	Ø 14 Ø 5mm	56mm	x100 
--------	--------------	------	--



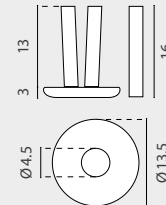

screw 

12.536	Ø 14 Ø 5mm	32mm	x100 
--------	--------------	------	--

push 

12.537	Ø 13.5 Ø 4.5mm	16mm	x100 
--------	------------------	------	--

GRIPPER DETAIL

INFORMATION

*mm



This "H" transparent PVC gripper takes up to 2mm thickness cards with 180° angle connection. Ideal for joining cardboard displays, mobiles construction or for displaying signage at POS.



H180 GRIPPER

SIZE

12.197 19x7x25mm x100 

"H" 180° GRIPPER

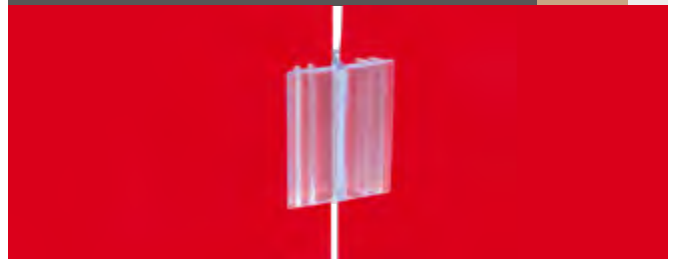

GRIPPER DETAIL

INFORMATION

*mm



This "V" transparent PVC gripper takes up to 2mm thickness cards with 60° angle connection. Ideal for joining cardboard displays, mobiles construction or for displaying signage at POS.

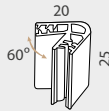

V60 GRIPPER

SIZE

12.371 20x25mm x100 

"V" 60° GRIPPER

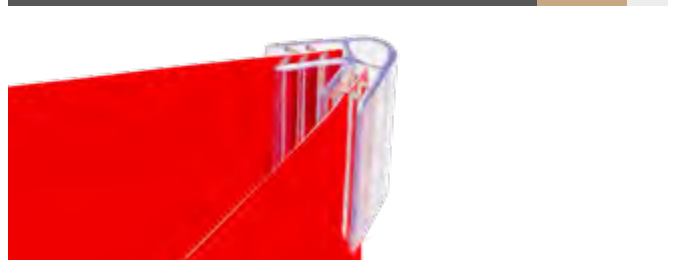

GRIPPER DETAIL

INFORMATION

*mm



This "L" transparent PVC gripper takes up to 2mm thickness cards with 90° angle connection. Ideal for joining cardboard displays, mobiles construction or for displaying signage at POS.

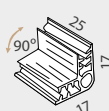

L90 GRIPPER

SIZE

12.198 17x17x25mm x100 

"L" 90° GRIPPER



GRIPPER DETAIL

INFORMATION

*mm



This "Y" transparent PVC gripper takes up to 2mm thickness cards with a 3 ways connection. Ideal for joining cardboard displays, mobiles construction or for displaying signage at POS.

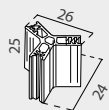

Y GRIPPER

SIZE

12.372 26x24x25mm x100 

"Y" GRIPPER



GRIPPER DETAIL

INFORMATION

*mm



This "X" transparent PVC gripper takes up to 2mm thickness cards with a 4 ways connection. Ideal for joining cardboard displays, mobiles construction or for displaying signage at POS.

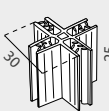







X GRIPPER

SIZE

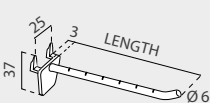
12.199 30x30x25mm x100 





"X" GRIPPER



PRONG DETAILS		INFORMATION		*mm
		Simple Plastic prong with 2 direct insert hook spikes wich lets you avoid the need for punching holes.		
SIMPLE PRONG	LENGTH			
12.261	51mm	x50		
12.262	76mm	x50		
12.263	102mm	x50		
12.264	127mm	x50		
12.265	152mm	x50		
12.266	210mm	x50		

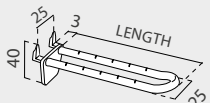





SIMPLE QUICK-STICK PRONG

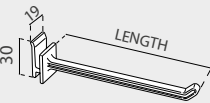

PRONG DETAILS		INFORMATION		*mm
		Double Plastic prong with 2 direct insert hook spikes wich lets you avoid the need for punching holes.		
DOUBLE PRONG	LENGTH			
12.258	105mm	x50		
12.259	152mm	x50		
12.260	210mm	x50		





DOUBLE QUICK-STICK PRONG

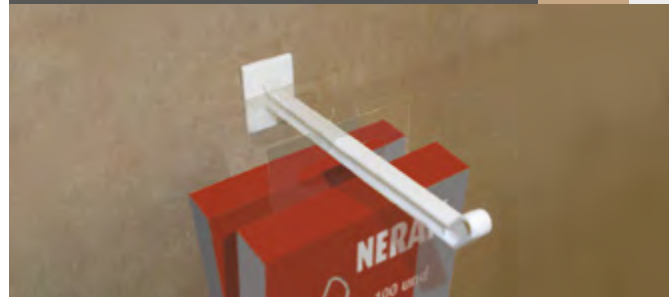

PRONG DETAILS		INFORMATION		*mm
		Plastic prong with plate for inserting in cardboard panels or displays. It requires a 19x10mm hole to fit.		
INSERT PRONG	LENGTH			
12.272	66mm	x50		
12.273	92mm	x50		
12.274	118mm	x50		
12.275	144mm	x50		
12.276	205mm	x50		

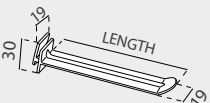
INSERT PRONG



PRONG DETAILS		INFORMATION		*mm
		Plastic flat prong with plate for inserting in cardboard panels or displays. It requires a 19x10mm hole to fit.		
INSERT FLAT	LENGTH			
12.269	61mm	x50		
12.270	105mm	x50		
12.271	130mm	x50		

INSERT FLAT PRONG

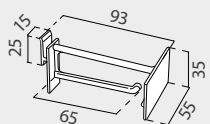

PRONG DETAILS		INFORMATION		*mm
		Plastic prong with holder and plate for inserting in cardboard panels. It requires a 19x10mm hole to fit in.		
INSERT PRONG	LENGTH			
12.112	65mm	x50		

INSERT PRONG WITH HOLDER



PRONG DETAILS

INFORMATION *mm

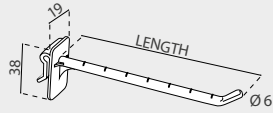

This plastic prong can be attached to thickness from 2 to 4mm. Available in 2 different lengths. Needs hole of 19x10mm.

CLIP PRONG	LENGTH		
12.267	110mm	x50	
12.268	195mm	x50	

CLIP PRONG



PRONG DETAILS

INFORMATION *mm

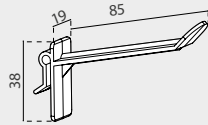
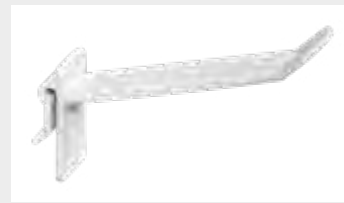

This plastic prong can be attached to thickness from 2 to 4mm. Available in 2 different lengths. Needs hole of 19x10mm.

CLIP FLAT PRONG	LENGTH		
12.330	85mm	x50	

CLIP FLAT PRONG

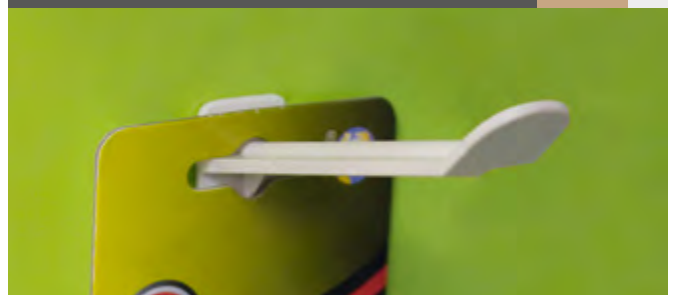

HOOK DETAILS

INFORMATION *mm



Clip-on over cardboard displays. "S" Hook is suitable to display small items, coupons, bags or samples. 15mm wide clip.

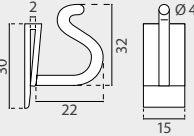

"S" HOOK	SIZE		
12.074	30x22x15mm	x100	

"S" COUPON HOOK



HOOK DETAILS

INFORMATION *mm



Clip-on over cardboard displays. "D" Hook is ideal for presenting coupons, gift cards or promotional products. 10mm wide clip.

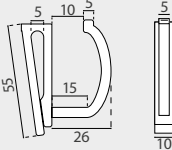

"D" HOOK	SIZE		
12.279	55x26x10mm	x100	

"D" COUPON HOOK





HOOK DETAILS

INFORMATION *mm

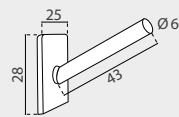

25x28mm adhesive pad with a 43mm length hook to attach directly to displays. No need for holes. For showing small items, like coupons or bags.



ADHESIVE HOOK	SIZE		
12.485	28x25x43mm	x100	 

SMALL PLASTIC PRONG



P.O.S. Solutions

12

Complete range of Grippers, Hangers, Price Holders, Hooks and Magnets which provide an integral solution for the exhibition at the Point Of Sale.

- 486 FRAME KIT
- 500 MINI FRAME KIT
- 502 PRICE HOLDERS
- 517 PRICE CARDS
- 518 HANGING SOLUTIONS
- 535 SUCTION CUPS
- 540 GRIPPERS
- 548 CARDBOARD SOLUTIONS
- 550 CARDBOARD ACCESSORIES
- 552 SHELF SIGNAGE







FRAME COLOR DETAILS







INFORMATION

This high quality Frames are available in 4 standard sizes and 8 different colors. The poster is inserted from the short side of the frame. All frames are suitable for being used in portrait or landscape setup. Thanks to its design and its multiple accessories to combine it, the Frame Kit is one of the most used systems for displaying prices or promotions in the supermarkets and in retail stores.

FRAME	SIZE	STANDARD	
12.053	105x148mm	A6	x10 
12.054	148x210mm	A5	x10 
12.055	210x297mm	A4	x10 
12.056	297x420mm	A3	x10 

PROTECTOR DETAILS



PROTECTOR	SIZE	THICKNESS	
12.057	A6	0.3mm	x10 
12.058	A5	0.3mm	x10 
12.059	A4	0.3mm	x10 
12.060	A3	0.3mm	x10 

FRAMES



POSTER PROTECTOR



INFORMATION

This sleeves protectors are made in 0.3mm "anti-reflective" and transparent glasspack. It is ideal for protecting your promotions from exposure or deterioration.

"T" CLIP DETAILS



INFORMATION

*mm

"T" Clip is designed for being combined with Ø10mm telescopic poles, also is suitable for using with any Frame of Frame Kit Series. This "T" Clip is available in 4 different colors: transparent, red, black and grey.

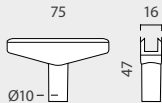

"T" CLIP COLOR

12.077



x20 

"T" CLIP



FRAME JOIN CLIP DETAILS

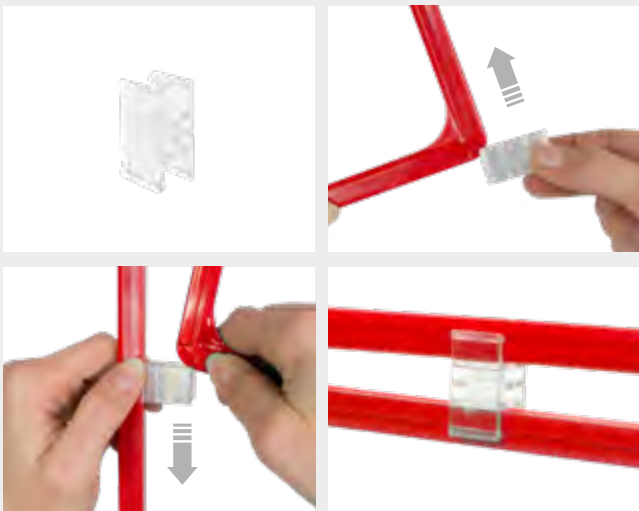

INFORMATION

*mm

The Frame Join Clip is made of transparent plastic and it is suitable for being used with all our Frame Kit Series and also, for being used with portrait and landscape orientation. It is ideal for joining together frames and create associated promotions chained by 2 or more Frames Kits.

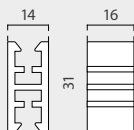

FRAME JOIN

12.087

x20 

FRAME JOIN CLIP



BIG CLIP DETAILS



INFORMATION

The Big Clip is made of transparent plastic. Suitable for being used with Frame Kit Series. It is ideal for wire baskets, tubes or shelves.

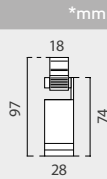

*mm

BIG CLIP

MAX. SIZE

50.813

28x97x27mm

x20 

BIG CLIP FOR FRAME KIT



CLAMP DETAILS

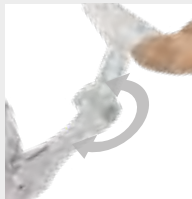

INFORMATION

This big Clamp + "T" Clip are made of transparent plastic. Suitable for being used with all Frame Kit series. Ideal for tubes, dumpbins or shelves.

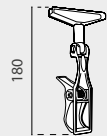

*mm

CLAMP

HEIGHT

12.291

180mm

x20 

CLAMP FOR FRAME KIT



UNICLIPPER DETAILS



INFORMATION

This Uniclipper is made of opaque plastic and it includes a "T" Clip. Suitable for being used with all Frame Kit series. Ideal for tubes, dumpbins or for shelves.

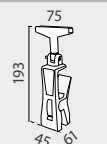

*mm

UNICLIPPER

MAX. SIZE

50.860

75x193x61mm

x20 

UNICLIPPER FOR FRAME KIT



BASKET CLIP DETAILS



INFORMATION

The Basket Clip is made of transparent plastic. It is suitable for being used with all Frame Kit Series. Also it is ideal for connecting frames with the wire dumpbins or any Ø10mm tubes.

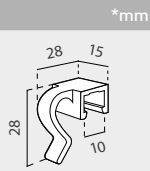

BASKET CLIP

12.084	x20 
--------	---

BASKET CLIP





TUBE CLIP DETAILS



INFO

*mm



- REF 12.083  Ø26
- REF 12.082  Ø22
- REF 12.081  Ø18

Transparent ring with frame clip connector. 3 diameters available.

TUBE CLIP	DIAMETER	
12.081	Ø18mm	x20 
12.082	Ø22mm	x20 
12.083	Ø26mm	x20 

TUBE CLIP



RING "T" CLIP DETAILS

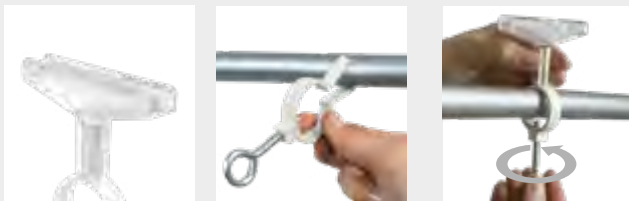

INFORMATION

*mm

Transparent "T" Clip + Adjustable white Ring. Suitable for being used with Frame Kit. It is suitable for being used with all Frame Kit Series. Ideal for poles, tubes, baskets or grating.

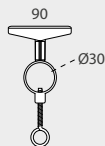

RING "T"	DIAMETER	
12.292	Ø30mm	x20 

RING "T" CLIP



RING CLIP DETAILS



INFORMATION

*mm

This Clip is made of transparent plastic and it features a 360° rotatory ring. It is suitable for being used with all Frame Kit Series. Ideal for holding frames.



RING CLIP

12.090

x20 



RING CLIP
FOR FRAME KIT



10 HOOK CLIP DETAILS

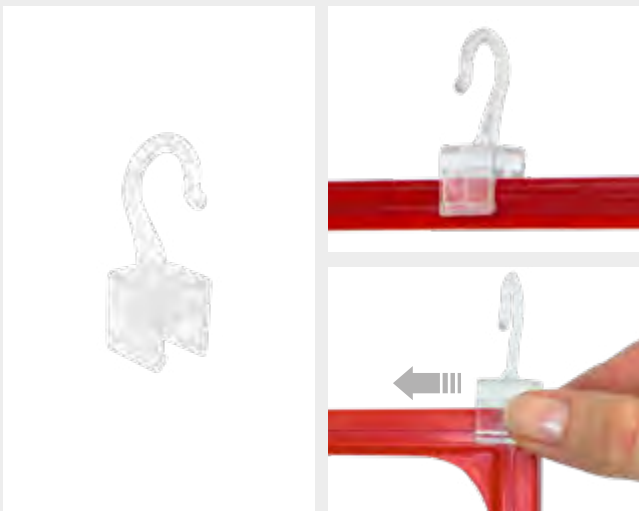

INFORMATION

*mm

This Hook Clip is made of transparent plastic. It is suitable for being used with all Frame Kit Series. It is ideal for hanging promotions at the supermarkets.



HOOK CLIP 10

DIAMETER

12.091

Ø10mm

x20 

HOOK CLIP 10mm



20 HOOK CLIP DETAILS

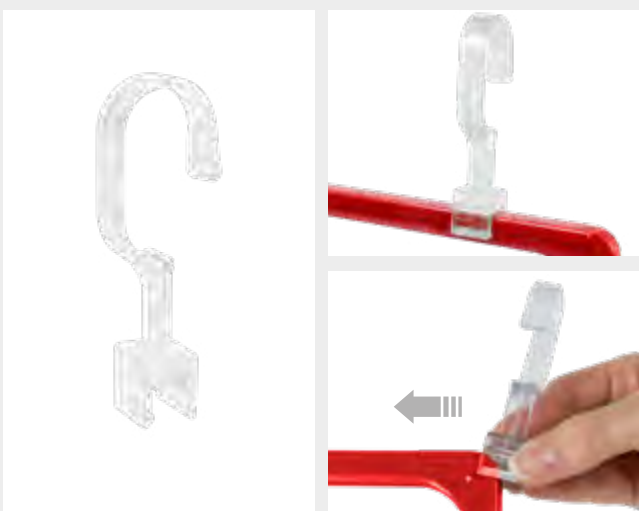

INFORMATION

*mm

This big Hook Clip is made of transparent plastic. It is suitable for being used with all Frame Kit Series. It is ideal for hanging promotions at the supermarkets.



HOOK CLIP 20	DIAMETER		
12.092	Ø20mm	x20 	

HOOK CLIP 20mm



FRAME SIDE HOOK DETAILS





INFORMATION

*mm

This Frame Side Hook is made of transparent plastic. It features two designs (left and right) for being used on both sides of any Frame Kit Series. Ideal for wire baskets or dumpbins.



SIDE CLIP	DIAMETER		
12.094	Ø20mm	 x10 Uni	 x10 Uni

FRAME SIDE HOOK



RAIL CLIP DETAILS

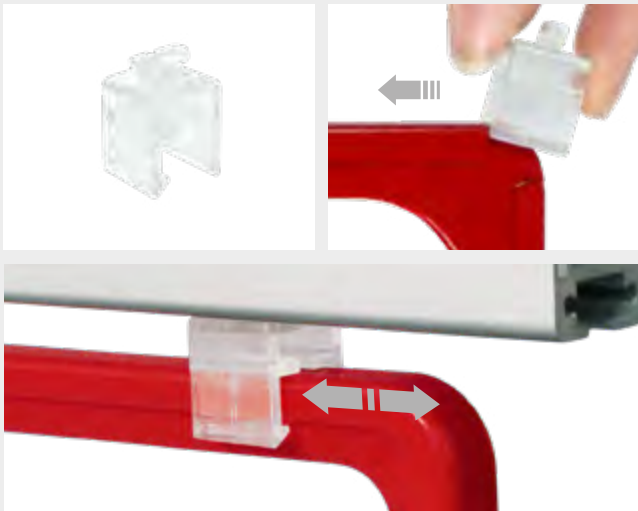

INFORMATION

*mm

The Rail Clip is made of transparent plastic. It is suitable for being used with all Frame Kit Series. Also it is ideal for connecting frames to ceiling-rails and get an easily mobile Frame Kit system over all the products in promotion.

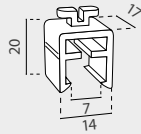

RAIL CLIP

12.089 x20 

RAIL CLIP



WALL CLIP DETAILS



INFORMATION

*mm

The Wall Clip is made of transparent plastic. It is suitable for being used with all Frame Kit Series. It is ideal for connecting frames with walls, inclined surfaces or in any other place where leaving the Frame Kit fixed was needed.

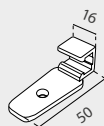

WALL CLIP

12.080 x20 

WALL CLIP



FRAME ADHESIVE CLIP DETAILS



INFORMATION

*mm

The Frame Adhesive Clip is made of transparent plastic. It is suitable for being used with all Frame Kit Series. Also it is ideal for fixing frames to different surfaces thanks to its adhesive mobile Frame Kit system over all the products in promotion.

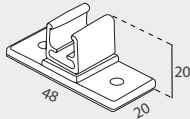

ADHESIVE CLIP

SIZE

12.639

48x20x20mm

x100 

FRAME ADHESIVE CLIP

NEW



FRAME BASE CLIP DETAILS



INFORMATION

*mm

This Base Clip is made of transparent plastic. Its slightly inclined design is ideal for displaying promotions and offers by using any Frames Kit Series.

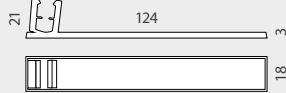

BASE CLIP

12.093

x10 

FRAME BASE CLIP



GRIPPER CLIP DETAILS

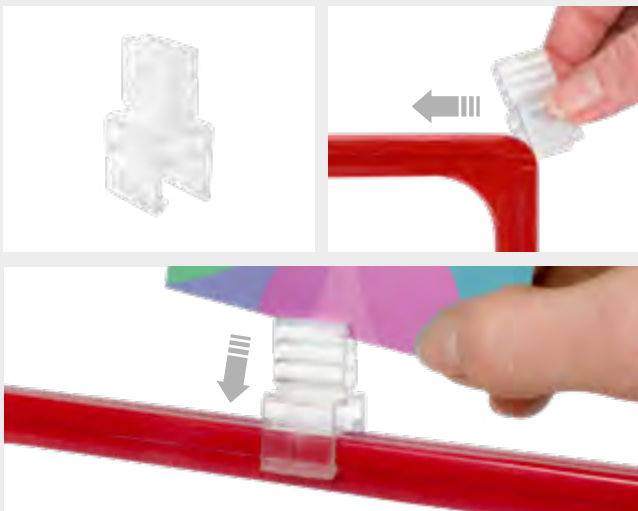

INFORMATION

*mm

The Gripper Clip is made of transparent plastic and it is suitable for being used with all Frame Kit Series. Also it is perfect for attaching last-minute promotions to a Frame Kit. It holds cards up to 1mm thick.

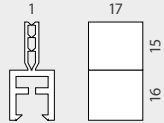

GRIPPER CLIP

12.088

x20 

GRIPPER CLIP



FRAME KIT GRIPPER DETAILS



INFORMATION

*mm

This Gripper is made of transparent plastic. It is suitable for being used with all Frame Kit Series. Ideal for cards or promotional labels up to 3mm thickness.

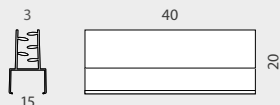

FRAME GRIP

12.524

x100 

FRAME KIT GRIPPER



SUPPORT DETAIL

INFORMATION

*mm



This support is made of grey plastic. It is suitable for being used with all Frame Kit Series. It is ideal as magnetic base or holder for frames on gondolas or metallic shelves.

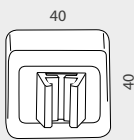

FRAME MAG.

12.096

x20 

FRAME CLIP MAGNETIC SUPPORT



SUPPORT DETAIL

INFORMATION

*mm



This support is made of grey plastic. It is suitable for being used as intermediate support for telescopic tubes. It is ideal as holder for telescopic tubes on gondolas or metallic shelves.

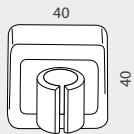

MID MAG.

12.097

x20 

MIDDLE TUBE MAGNETIC SUPPORT



SUPPORT DETAIL

INFORMATION

*mm



This support is made of grey plastic. It is suitable for being used as end support for telescopic tubes. It is ideal for holding telescopic tubes on gondolas or metallic shelves.

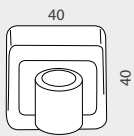

END TUBE

12.098

x20 

END TUBE MAGNETIC SUPPORT



SUPPORT DETAIL

INFORMATION

*mm



This support is made of grey plastic. It is suitable for being used as holder for all Frame Kit series. It is ideal as magnetic base or holder for frames on gondolas or metallic shelves.

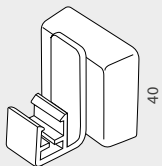

HOOK MAG.

12.099

x20 

FRAME HOOK MAGNETIC SUPPORT



MAGNETIC CLIP

INFORMATION

*mm



This T Clip is made of grey plastic. It is suitable for being used as holder for all Frame Kit series. It is ideal as magnetic base or holder for frames on gondolas or metallic shelves.

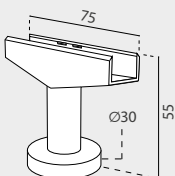

T CLIP

12.079

x20 

"T" CLIP MAGNETIC SUPPORT











PLASTIC BASE STAND DETAILS

*mm



INFORMATION

"T" Clamp + Telescopic Tube + Plastic Base. Ideal for placing underneath pallets.

PLASTIC	SIZE *mm		
12.239	Pole: 150+150	x10	
12.240	Pole: 150+150	x10	
12.062	Pole: 300+300	x10	
12.063	Pole: 300+300	x10	
12.065	Pole: 500+500	x10	
12.066	Pole: 500+500	x10	
12.242	Pole: 750+750	x10	
12.243	Pole: 750+750	x10	

EXTENDABLE FLOOR
PLASTIC STAND



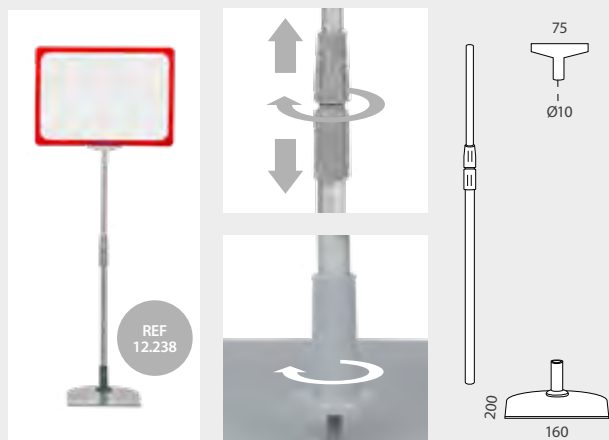

METALLIC BASE STAND DETAILS

*mm



INFORMATION

"T" Clamp + Telescopic Tube + Metallic Base. Ideal for placing underneath pallets.

METALLIC	SIZE *mm		
12.238	Pole: 150+150	x10	
12.061	Pole: 300+300	x10	
12.064	Pole: 500+500	x10	
12.241	Pole: 750+750	x10	

EXTENDABLE FLOOR
METALLIC STAND



* the frames at this page are available but not included

STAND DETAILS

INFORMATION

*mm



This Stand includes 1 telescopic pole (1900mm max. height) + Ø240mm rounded metal base + "T" Clamp. Ideal for placing close to the product.

EXT. STAND STAND POLE

12.068	950+950mm	x10 
--------	-----------	---

EXTENDABLE CLAMP STAND



STAND DETAILS

INFORMATION

*mm



It includes 1 telescopic pole (1900mm max. height) + Ø240mm rounded metal base + 1 Upper arm + 2 hooks. Ideal for placing close to the product.

EXT. STAND STAND POLE UPPER ARM

12.405	950+950mm	507mm	x10 
--------	-----------	-------	---

EXTENDABLE 1 ARM STAND



STAND DETAILS

INFORMATION

*mm



It includes 1 telescopic pole (1900mm max. height) + Ø240mm metal base + "T" Clamp + 1 Upper arm + 4 hooks. Ideal for placing close to the product.

EXT. STAND STAND POLE UPPER ARM

12.406	950+950mm	1010mm	x10 
--------	-----------	--------	---

EXTENDABLE 2 ARM STAND



* the frames at this page are available but not included

CLAMP SUPPORT DETAILS



INFORMATION

*mm

This clamp is suitable for pole stands and it is ideal for displaying promotional posters or pricing banners beside the pallets of supermarkets or stores.

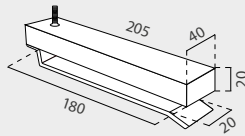

PALLET CLAMP

LENGTH

12.400

205mm

x10 

CLAMP SUPPORT FOR PALLET



EXTENDABLE STAND DETAILS

*mm



INFORMATION

This extendable support features a "T" Clip + Telescopic Tube + Spring so it is suitable for being used with all Frame Kit Series. Thanks to its adjustable spring Extendable Stand is ideal for being used on wire dumpbins, wire baskets or pegboards at supermarkets or stores. Once incorporated into the wire dumpbin or the pegboard, you can adjust the height of the displaying thanks to its telescopic pole. It is perfect for displaying promotions, temporary sales or for price graphics.

SPRING STAND

HEIGHT

12.069

310-532mm

x10 

EXTENDABLE STAND WITH SPRING



* the frames at this page are available but not included in the price.

MINIBOARD DETAILS



INFORMATION

*mm

This Mini Board for Ø10mm telescopic tubes is made in grey ABS. For using with a frame kit. To place the Mini Board at half height of the pole just break the top flap. Thanks to its attachable design, it is ideal to use with 1 or 2 facing boards and create a double-sided display for your tube display.

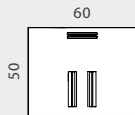

MINI BOARD

SIZE

12.554

50x60mm

x20 

MINI BOARD
FOR Ø10mm TELESCOPIC TUBE



SUPPORT DETAILS



INFORMATION

*mm

This transparent graphic support is made of plastic and it is suitable for combining with telescopic tubes. It holds a ±1.5mm maximum thickness cards. It is perfect for displaying promotions at the supermarkets.

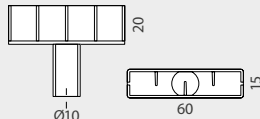

SUPPORT

12.338

x25 

GRAPHIC SUPPORT



FRAME DETAILS

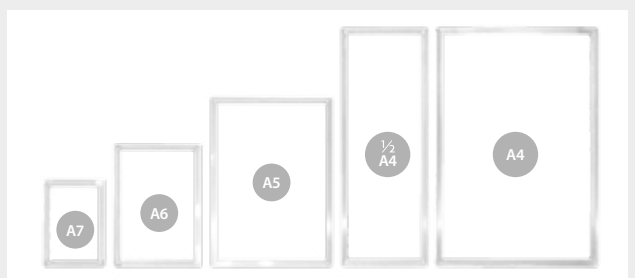
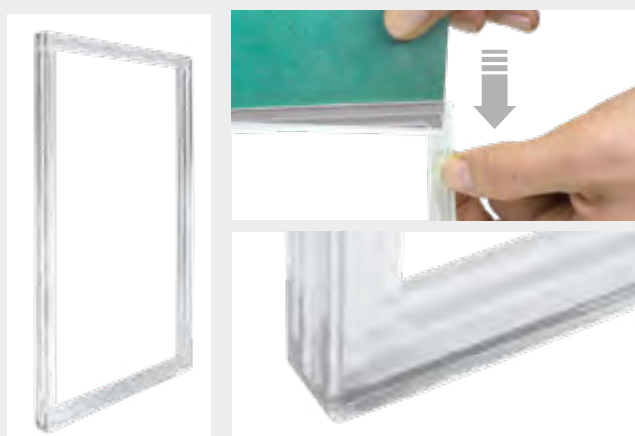

INFORMATION

This high quality and extrafine transparent frames Mini Frames are available in 5 sizes. The poster is inserted from the short side. Also it features its exclusive full range of accessories. Thanks to its design and its multiple accessories to combine it, the Mini Frame Kit is ideal for displaying prices or promotions in the supermarkets and retail stores.





FRAMES	SIZE	GRAPHIC SIZE		
12.336	 74x105mm	A7	x10	
12.322	 105x148mm	A6	x10	
12.323	 148x210mm	A5	x10	
12.324	 105x297mm	1/2 A4	x10	
12.325	 210x297	A4	x10	

TRANSPARENT MINI FRAMES



PROTECTOR DETAILS



PROTECTOR	SIZE	THICKNESS		
12.337	A7	0.3mm	x10	
12.057	A6	0.3mm	x10	
12.058	A5	0.3mm	x10	
12.328	1/2 A4	0.3mm	x10	
12.059	A4	0.3mm	x10	

POSTER PROTECTOR

0.3mm thick

Anti Reflex

3 sides open



INFORMATION

This sleeves protectors are made in 0.3mm "anti-reflective" and transparent glasspack. It is ideal for protecting your promotions from exposure or deterioration.

CARD CLIP DETAIL

INFORMATION

*mm



This Clip is made of transparent plastic and it is perfect for attaching last-minute cards promotions to a Mini Frame. It holds cards up to Xmm thick.

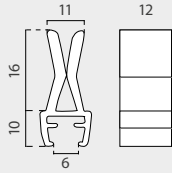

MINI CARD CLIP

12.332

x20 

MINI CARD CLIP



BASE CLIP DETAIL

INFORMATION

*mm



This Base Clip is made of transparent plastic. Its slightly inclined design is ideal for displaying by using any Frames Kit Series

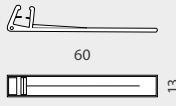

MINI BASE CLIP

12.333

x20 

MINI BASE CLIP

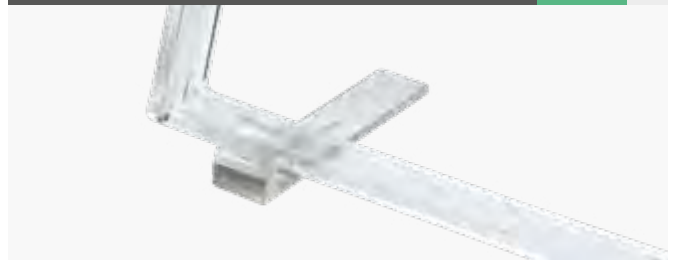

CARD CLIP DETAIL

INFORMATION

*mm



This Join Clip is made of transparent plastic. It is ideal for joining together frames and for creating associated promotions chained by various Mini Frames Kit.

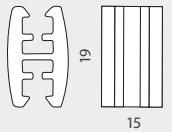

MINI JOIN CLIP

12.334

x20 

MINI JOIN CLIP



CARD CLIP DETAIL

INFORMATION

*mm



This Frame Side Hook is made of transparent plastic. It features two designs (left and right) for being used on both sides of any Mini Frame Kit Series.

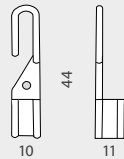

MINI SIDE HOOK

12.095

x20 

⊖10 uni

⊕10 uni

MINI SIDE HOOK



CARD CLIP DETAIL

INFORMATION

*mm



This Hook Clip is made of transparent plastic. Suitable for being used with all Frame Kit Series. It is ideal for hanging the promotions at retail stores or supermarkets.

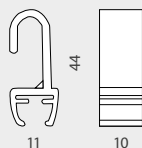

MINI HANGING

12.335

x20 

MINI HANGING HOOK



CLAMP DETAILS





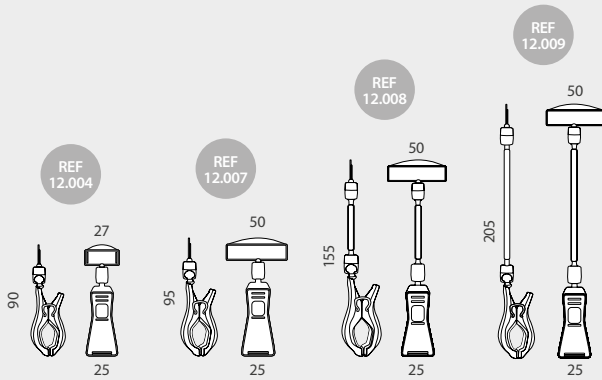

DIMENSIONS

*mm



INFORMATION

This transparent Clamp holder provides a whole angle view thanks to its movable ball joint (2 ball-joints for 12.009 and 12.008 models). With a 25mm wide lower clamp and an upper card holder wich allows the insertion of cards up to 1mm thickness. . It is ideal for displaying close to the product and it is widely used in price tags and goods exhibitions in the shopping mall which can make thing more obvious and catch customers attentions.

C. 205	COMBINATION	LENGTH	BALL-JOINT		
12.009	Clamp + Holder	205mm	2	x25	
12.008	Clamp + Holder	155mm	2	x25	
12.007	Clamp + Holder	95mm	1	x25	
12.004	Clamp + Holder	90mm	1	x25	

HOLDER WITH CLAMP
PRICE HOLDERS



CLAMP DETAILS

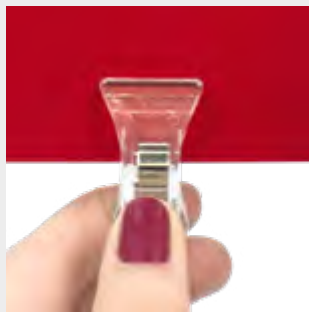



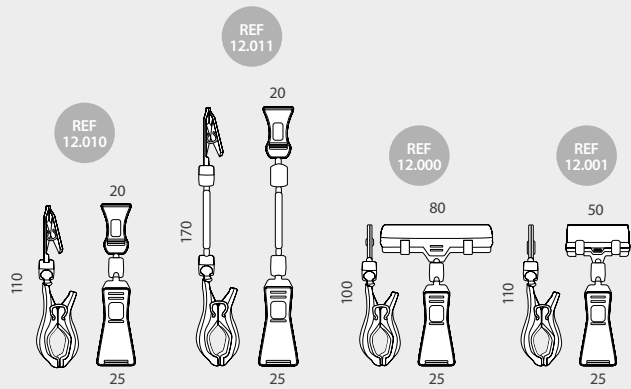

DIMENSIONS

*mm



INFORMATION

This transparent Clamp holder provides a whole angle view thanks to its movable ball joint (2 ball-joints for 12.011 model). With a 25mm wide lower clamp and a 20mm upper clip (80mm upper clamp for 12.000 model and 50mm upper clamp for 12.001 model). It is ideal for displaying close to the product and it is widely used in price tags and goods exhibitions in the shopping mall which can make thing more obvious and catch customers attentions.

C. 205	COMBINATION	LENGTH	BALL-JOINT			
12.010	Clamp + Clip	110mm	1	x25		
12.011	Clamp + Clip	170mm	2	x25		
12.000	Clamp + Clamp	100mm	1	x25		
12.001	Clamp + Clamp	110mm	1	x25		

CLIP WITH CLAMP
PRICE HOLDERS



CLIP DETAILS

DIMENSIONS

*mm

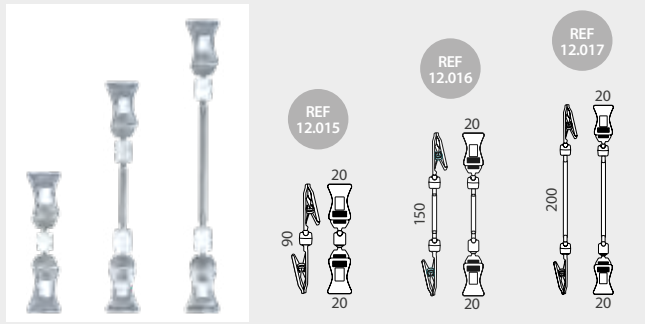

INFORMATION

This transparent holder provides a whole angle view thanks to its double movable ball joint. With a 20mm wide lower clip and a 20mm upper clip. Length from 90 to 200mm. It is ideal for displaying close to the product.

CLIP	COMBINATION	LENGTH	BALL-JOINT	
12.015	Clip + Clip	90mm	1	x25 
12.016	Clip + Clip	150mm	2	x25 
12.017	Clip + Clip	200mm	2	x25 

DOUBLE CLIP
PRICE HOLDERS



CLIP DETAILS



DIMENSIONS

*mm

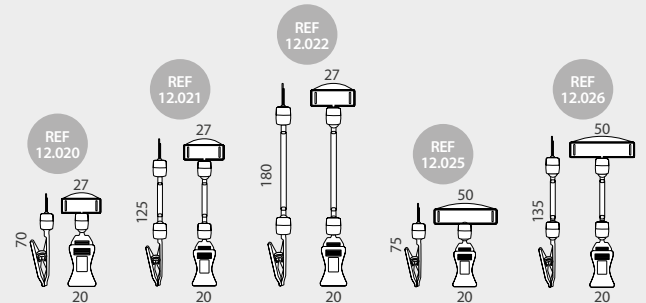

INFORMATION

This transparent holder provides a whole angle view thanks to its double movable ball joint. With a 20mm wide lower clip and 20mm or 50mm upper clip. Product. Length from 70 to 180mm. It is ideal for displaying close to the product.

CLIP	COMBINATION	LENGTH	BALL-JOINT	
12.020	Clip + Holder	70mm	1	x25 
12.021	Clip + Holder	125mm	2	x25 
12.022	Clip + Holder	180mm	2	x25 
12.025	Clip + Holder	75mm	1	x25 
12.026	Clip + Holder	135mm	2	x25 

CLIP WITH HOLDER
PRICE HOLDERS



CLIP DETAILS



DIMENSIONS

*mm

INFORMATION

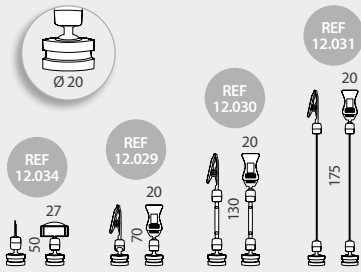

This transparent holder provides a whole angle view thanks to its double movable ball joint. With a Ø20mm lower magnetic base and a 20mm upper clip or 27mm upper (1mm thick) holder. It is ideal for placing prices or promotions near to the product at supermarkets.

MAGNETIC	COMBINATION	LENGTH	BALL-JOINT	
12.034	Magnet + Holder	50mm	1	x25 
12.029	Magnet + Clip	70mm	1	x25 
12.030	Magnet + Clip	130mm	2	x25 
12.031	Magnet + Clip	175mm	2	x25 

MAGNETIC PRICE HOLDERS



CLIP DETAILS

DIMENSIONS

*mm

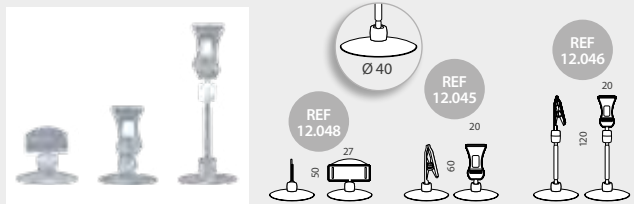

INFORMATION

*mm

This price holder provides a whole angle view thanks to its movable ball joint. With a Ø40mm lower suction cup and upper 27mm card holder or 20mm clip.

SUCTION	COMBINATION	LENGTH	BALL-JOINT	
12.048	Suction + Holder	50mm	1	x25 
12.045	Suction + Clip	60mm	1	x25 
12.046	Suction + Clip	120mm	2	x25 

SUCTION PRICE HOLDERS



HOLDER DETAILS

INFORMATION

*mm

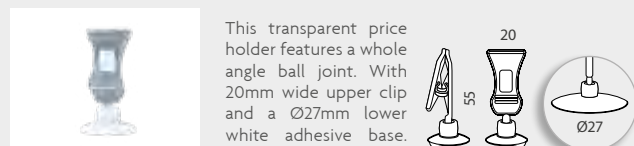

This transparent price holder features a whole angle ball joint. With 20mm wide upper clip and a Ø27mm lower white adhesive base.

ADHESIVE CLIP	LENGTH	
12.042	55mm	x25 

ADHESIVE PRICE HOLDER

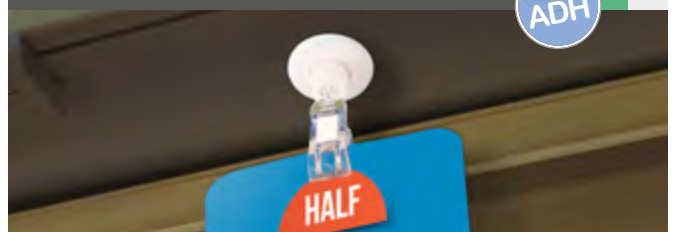

BASE DETAILS



DIMENSIONS

*mm



INFORMATION

50 or 160mm length price holder with whole angle ball joint. With a Ø55mm lower base and a 20mm upper clip. It is ideal for displaying close to the product.

BASE	COMBINATION	LENGTH	BALL-JOINT		
12.039	 Base + Clip	50mm	1	x25	
12.040	 Base + Clip	160mm	2	x25	

Ø55mm BASE PRICE HOLDERS



CLIP DETAILS



DIMENSIONS

*mm

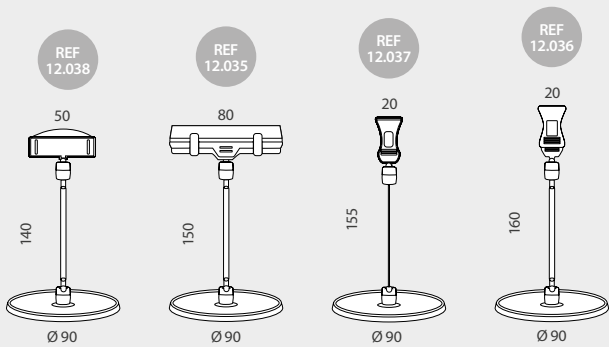

INFORMATION

With double movable ball joint this Ø90mm base (transparent or yellow) is ideal for placing prices near to the product without the need of holding the price-holder. Perfect for displaying bakery, fruit or shelving promotions.

BASE	COMBINATION	LENGTH	BALL-JOINT		
12.038	 Base + Holder	140mm	2	x25	
12.035	 Base + Clamp	150mm	2	x25	
12.037	 Base + Clip	155mm	2	x25	
12.036	 Base + Clip	160mm	2	x25	

Ø90mm BASE PRICE HOLDERS



PRICE HOLDER DETAILS

INFORMATION *mm

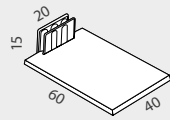

Ideal for informative notes, menus or prices closer to the promotion. It features a straight clip price holder, made of transparent plastic.

STRAIGHT BASE

SIZE

12.208

40x60mm

x100



STRAIGHT BASE PRICE HOLDER



PRICE HOLDER DETAILS

INFORMATION *mm

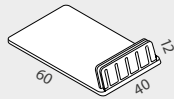

Ideal for informative notes, menus or prices closer to the promotion. It features an angular clip price holder made of transparent plastic.

ANGULAR BASE

SIZE

12.459

40x60mm

x100



ANGULAR BASE PRICE HOLDER



PRICE HOLDER DETAILS

INFORMATION *mm

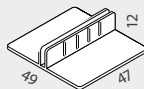

This squared clip base for price holders is made of transparent plastic and it is ideal for informative notes, cards or menu prices.

SQUARE BASE

SIZE

12.460

49x47mm

x100



SQUARE BASE PRICE HOLDER



PRICE HOLDER DETAILS

INFORMATION *mm

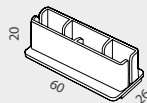

This transparent holder provides a sturdy adhesive fastening. Its 60mm width clip is ideal for displaying cards near to the product.

SIGN

SIZE

12.339

60x20mm

x25



SIGN PRICE HOLDER

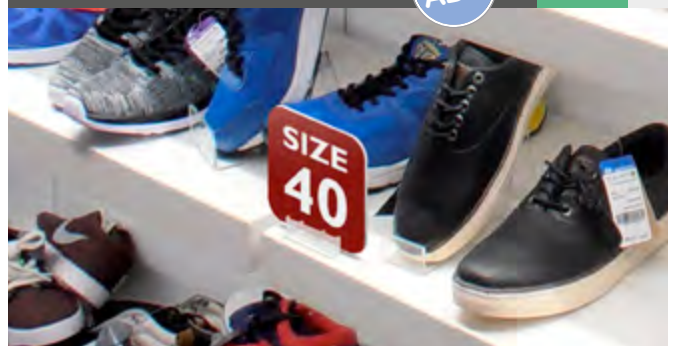

PRICE HOLDER DETAILS



INFORMATION

This stylish cube base holder features a XXmm clip ideal for displaying cards near to the product. Silver or black color available. Perfect for being used at supermarkets, restaurants, offices, hotels or retail stores.



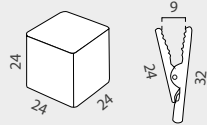

DIMENSIONS

*mm



CROCOCUBE

SIZE

17.038		24x24x170mm	x5 	
17.039		24x24x170mm	x5 	

CROCO CUBES



PRICE HOLDER DETAILS



INFORMATION

This hinged price holder provides an adjustable angle view thanks to its hinged steel holder. With an upper clip for holding sign and a sturdy Ø95mm flat steel base. This stylish price holder is ideal for placing informative notes or special offers near the products, food, bakery, fruits or for shelving promotions at the supermarkets.

DIMENSIONS

*mm

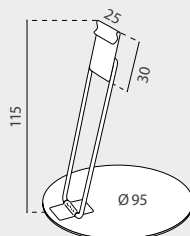

HINGED HOLDER

SIZE

12.519	Ø95x115mm	x10 	
--------	-----------	---	--

HINGED PRICE HOLDER



HOLDER DETAILS



DIMENSIONS

*mm

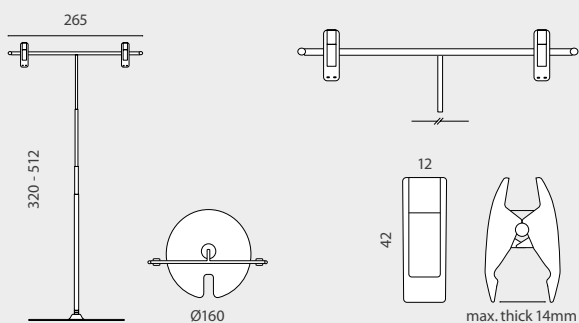

INFORMATION

These telescopic sign holders provide a high angle view thanks to its telescopic steel tube. With 2 upper clips made of transparent plastic for holding promotions and a sturdy flat base for placing under the products. The telescopic pole allows the possibility of placing the signs closer to the product. The change of promotion is really simple and fast and takes only few seconds. They are ideal for placing "banner" promotions, special offers or prices over the food or products at the supermarkets.

CLIP 260

12.052

Max.height:512mm

x10 

ADJUSTABLE SIGN HOLDER
WITH ROUNDED BASE



HOLDER DETAILS

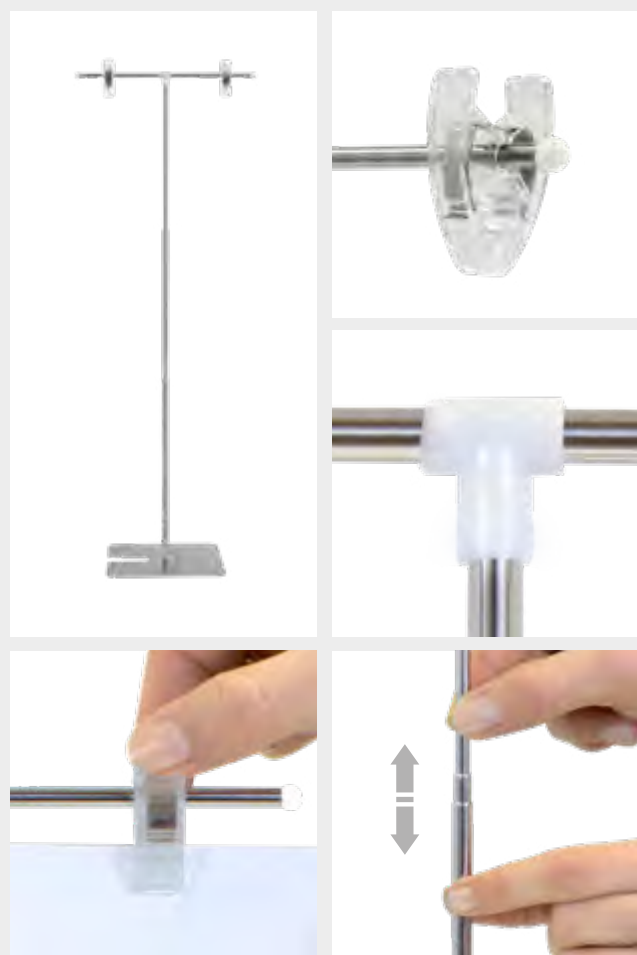

DIMENSIONS

*mm

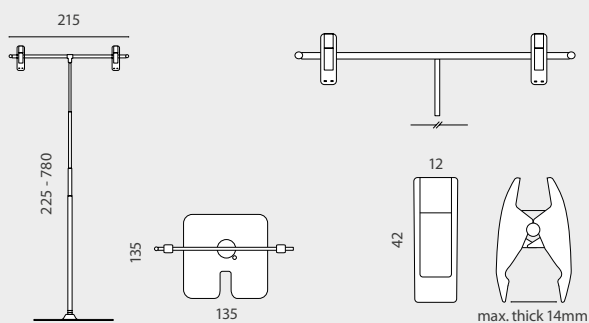

INFORMATION

These telescopic sign holders provide a high angle view thanks to its telescopic steel tube. With 2 upper clips made of transparent plastic for holding promotions and a sturdy flat base for placing under the products. The telescopic pole allows the possibility of placing the signs closer to the product. The change of promotion is really simple and fast and takes only few seconds. They are ideal for placing "banner" promotions, special offers or prices over the food or products at the supermarkets.

CLIP 210

12.050

Max.height: 800mm

x10 

ADJUSTABLE SIGN HOLDER
WITH SQUARED BASE



HOLDER DETAILS



DIMENSIONS

*mm

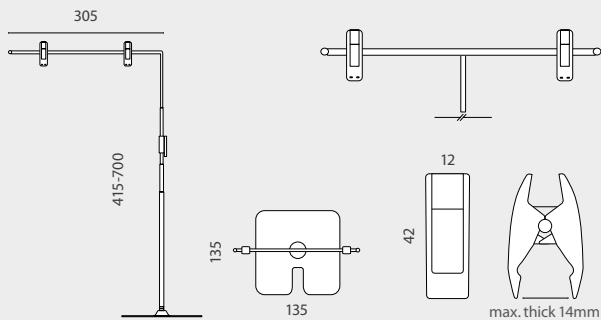

INFORMATION

These telescopic sign holders provide a high angle view thanks to its telescopic steel tube. With 2 upper clips made of transparent plastic for holding promotions and a sturdy flat base for placing under the products. The telescopic pole allows the possibility of placing the signs closer to the product. The change of promotion is really simple and fast and takes only few seconds. They are ideal for placing "banner" promotions, special offers or prices over the food or products at the supermarkets.

CLIP 310

12.051

Max.height: 700mm

x10 

ADJUSTABLE SIGN HOLDER
1 ARM WITH SQUARED BASE



LABEL SYSTEM

The label system provides different bases, price card connections or adapter for shelving.

Thanks to its multiple combinations, this Label System is ideal for prining and food use.



LABEL SYSTEM COMBINATIONS



CARD CLIP

INFORMATION

It is suitable for 50.820, 50.821, 50.822, 50.826 and 50.827 label system accessories.



CARD CLIP	SIZE	
50.823	18x21x9mm	x50 

ROD HOLDER

DIMENSIONS

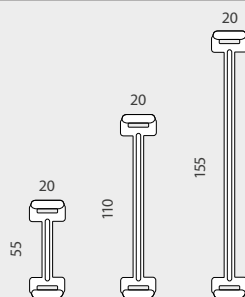

INFORMATION

This rod holder is suitable for being used with 50.810, 50.823, 50.824 and 50.829 label system accessories. There are 3 lengths available for pricing near the products.

ROD HOLDER	LENGTH	
50.820	155mm	x50 
50.821	110mm	x50 
50.822	55mm	x50 

ROD HOLDER CONNECTOR

INFORMATION

Suitable for 50.810, 50.853, 50.854 and 50.855 label system accessories.



CONNECTOR	SIZE	
50.824	19x11x12mm	x50 

LABEL BASE

INFORMATION

Suitable for 50.824 label system accessory.



LABEL BASE	SIZE	
50.810	120x80x3mm	x50 

LABEL SYSTEM



LABEL SYSTEM COMBINATIONS



EXTENSION STICK CONNECTOR



INFORMATION

Connector suitable for Extension Stick (Ref. 50.801, 50.802, and 50.803) and Card Clip (Ref. 50.823).

STICK CONN.

13.878 Suitable for Ø8mm tubes x50 

EXTENSION STICK

DIMENSIONS

*mm

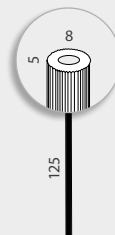

INFORMATION

This extension stick is suitable for being used with Multi Support Base (Ref.50.800). There are 3 lengths available for pricing near the products.

STICK	LENGTH		
50.801	125mm	x50	
50.802	150mm	x50	
50.803	200mm	x50	

CONNECTOR MULTI BASE - ROD



INFORMATION

Suitable for 50.800, 50.820, 50.821 and 50.822 label system accessories.



CONNECTOR	SIZE		
50.829	24x10x9mm	x50	

MULTI SUPPORT BASE



DIMENSIONS

*mm

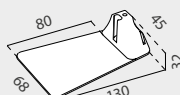

INFORMATION

This bases is suitable for 50.801, 50.802, 50.803 and 50.829 label system accessories. It also features a front card slot

MULTI BASE	SIZE		
50.800	130x68x32mm	x50	

CASSETTE PRICE HOLDER



INFORMATION

*mm

With 2 opening 81x26mm covers for price labels (not included).

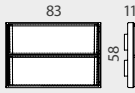



50.854 x25 

INFORMATION

*mm

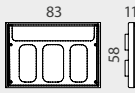
With 1 opening cover for place 82x56mm labels (not included).



50.855 x25 

CASSETTE UNIT PRICE HOLDER



DIGIT BOOKLET PACK

Each pack contains 6 Digit Booklets (3x Model A + 1x Model B + 1x Model C + 1x Model D) suitable for Ref. 50.853.

50.856 x25 

INFORMATION

*mm

With a 81x26mm cover and 6 digit sections. 6 Digit Booklets included.

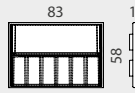

50.853 x25 

* Prix sur demande. | Preço disponível sob consulta. | Precio disponible bajo consulta.



SNAIL CLIP

INFORMATION

*mm

Suitable for 50.824 and 50.828 label system accessories.



SNAIL CLIP SIZE
50.825 44x36x64mm x25 

CASSETTE CONNECTOR

INFORMATION

*mm

Suitable for Card Clip (Ref. 50.823).



CONNECTOR SIZE
50.828 25x10x7mm x50 

ROD HOLDER CONNECTOR

INFORMATION

*mm

Fits with 50.810, 50.853, 50.854 and 50.855 label system accessories.



CONNECTOR SIZE
50.824 19x11x12mm x50 

SHARP PIN

INFORMATION

*mm

Suitable for Card Clip (Ref. 50.823).



SHARP PIN SIZE
50.826 85x22mm x50 

ICE PIN

INFORMATION

*mm

Ice Pin features a card hook. Suitable for Card Clip (Ref. 50.823).



ICE PIN SIZE
50.827 185x22mm x50 

STEM PIN

INFORMATION

*mm

Suitable for Cassette Price Holder (Ref. 50.853, 50.854, 50.855).

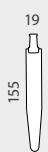

STEM PIN SIZE
50.830 155x19mm x50 

LABEL HOLDER DETAILS

INFORMATION *mm

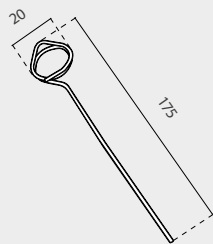

This metal Long Pin is ideal for use in garden centers or supermarkets as label holder.

LONG PIN SIZE

12.461	175x20mm	x100 
--------	----------	--

LONG PIN LABEL HOLDER



LABEL HOLDER DETAILS

INFORMATION *mm



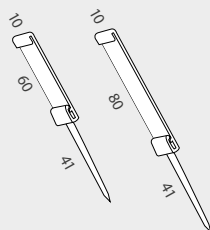

REF 12.209

REF 12.210



White Spike available in 2 label sizes. Ideal for supermarkets. Holds material up to 0.8mm.

ROD HOLDER LABEL SIZE

12.209	60mm	x100 
12.210	80mm	x100 

SPIKE LABEL HOLDER



LABEL HOLDER DETAILS

INFORMATION *mm

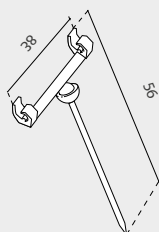

This white pin is ideal for using in garden centers or supermarkets. 1mm maximum label thickness.

LONG PIN SIZE

12.462	38x56mm	x100 
--------	---------	--

PIN LABEL HOLDER



PRICE HOLDER DETAILS



INFORMATION

DIMENSIONS *mm

This Clip Holder is made of transparent plastic and it is suitable for attaching cards, coupons, for adding promotions, price labels, etc. It adapts easily to shoes, kitchenware, crockery, tools, bags and any others similar products. Widely used in supermarket, shops, retails, shelves for attracting more customers' eyesights.

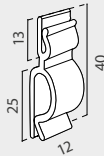

CLIP LABEL

SIZE

12.211

12x40mm

x100 

CLIP LABEL HOLDER



LABEL HOLDER DETAILS

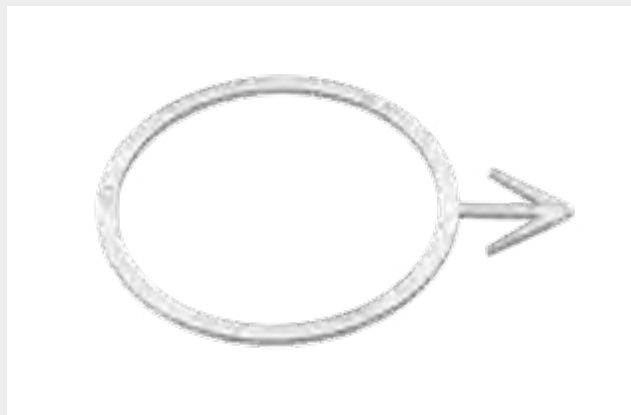

INFORMATION

DIMENSIONS *mm

This Ring Holder is made of transparent plastic and it is a cheap and effective way for attaching prices and offers to wine bottles or cylindrical products. Its arrowhead is flexible and allows the fastening of most tags or price labels. Frequently employed in supermarkets, malls, retail stores or at wine cellars.



RING LABEL

DIAMETER

12.296

Ø40mm

x100 

RING LABEL HOLDER









COLORED PRICE CARDS



YELLOW	COLOR	SIZE		
17.034Y		85x85mm	x10 	
17.035Y		115x115mm	x10 	
17.036Y		160x160mm	x10 	





GREEN	COLOR	SIZE		
17.034G		100x75mm	x10 	
17.035G		145x105mm	x10 	
17.036G		190x145mm	x10 	



PINK	COLOR	SIZE		
17.034P		100x75mm	x10 	
17.035P		145x105mm	x10 	
17.036P		190x145mm	x10 	



ORANGE	COLOR	SIZE		
17.034O		100x70mm	x10 	
17.035O		145x100mm	x10 	
17.036O		190x145mm	x10 	

SQUARE STAR



SQUARE STAR	SIZE		
17.000	S 100x70mm	x10 	
17.001	M 135x100mm	x10 	
17.002	L 160x160mm	x10 	
17.003	XL 185x130mm	x10 	
17.004	XXL 240x180mm	x10 	





"NEW" STAR



NEW	SIZE		
17.010	S 90x65mm	x10 	
17.011	M 140x100mm	x10 	
17.012	L 165x130mm	x10 	
17.013	XL 190x135mm	x10 	
17.014	XXL 250x175mm	x10 	





"V" EXPLOSION



EXPLOSION	SIZE		
17.005	S 95x70mm	x10 	
17.006	M 140x95mm	x10 	
17.007	L 150x120mm	x10 	
17.008	XL 190x135mm	x10 	
17.009	XXL 230x170mm	x10 	





"V" STAR



STAR	SIZE		
17.020	S 100x80mm	x10 	
17.021	M 140x100mm	x10 	
17.022	L 165x115mm	x10 	
17.023	XL 190x130mm	x10 	
17.024	XXL 240x180mm	x10 	





"OK" CLOUD



YELLOW "OK"	SIZE		
17.015	S 100x70mm	x10 	
17.016	M 140x100mm	x10 	
17.017	L 165x120mm	x10 	
17.018	XL 190x150mm	x10 	
17.019	XXL 245x175mm	x10 	

"OK" EXPLOSION



RED "OK"	SIZE		
17.025	S 95x80mm	x10 	
17.026	M 130x110mm	x10 	
17.027	L 155x120mm	x10 	
17.028	XL 180x145mm	x10 	
17.029	XXL 230x175mm	x10 	

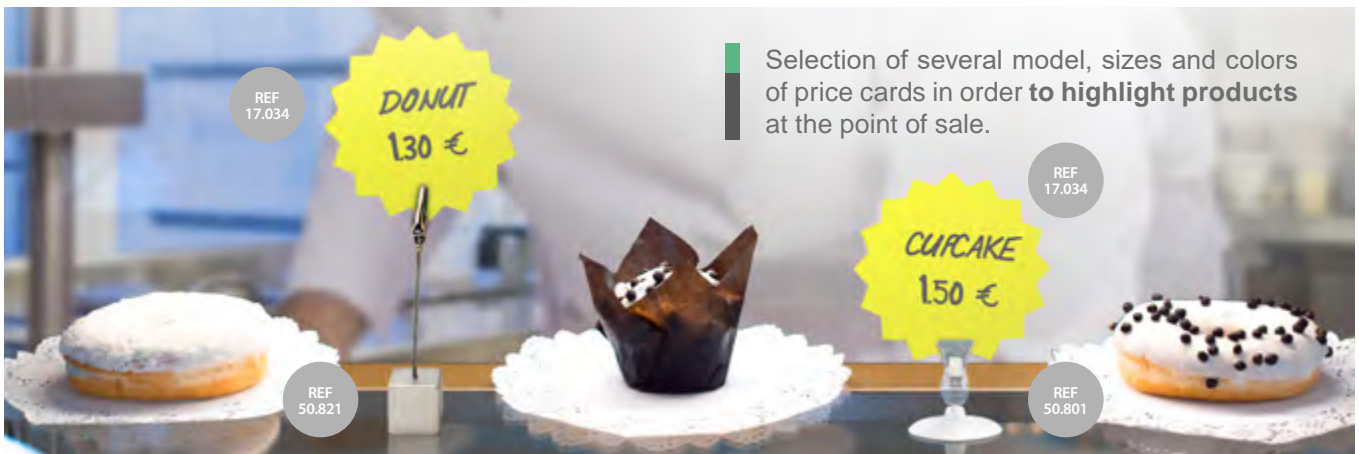



Selection of several model, sizes and colors of price cards in order to highlight products at the point of sale.

HOOK DETAILS

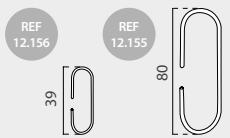
INFORMATION *mm



This hook with "C" shape is ideal for hanging plastic strips. 2 lengths of hooks are available.

"C" HOOK	LENGTH		
12.155	80mm	x100	
12.156	39mm	x100	

"C" METAL HOOK



HOOK DETAILS

INFORMATION *mm

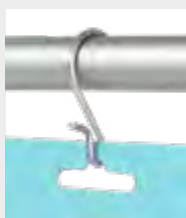

This Strip hook is made of steel and it is ideal for being used with the clip strips.

CLIP HOOK	LENGTH		
12.157	38mm	x100	

STRIP METAL HOOK



HOOKS DETAILS

INFORMATION *mm



"S" shape Hook made of steel. 2 sizes available. Ideal for hanging promotional signage from ceiling or wire baskets.

"S" HOOK	LENGTH	Ø WIRE	
12.152	27mm	Ø1.1mm	x100 
12.154	120mm	Ø2mm	x100 

"S" METAL HOOK



RINGS DETAILS

INFORMATION *mm

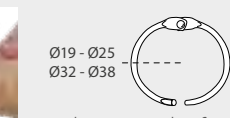
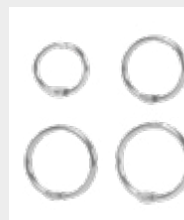

Metal ring with fast click closing. There are 4 diameters available. It is very used for hanging signage at points of sale.

METAL RING	DIAMETER		
12.160	Ø19mm	x100	
12.161	Ø25mm	x100	
12.162	Ø32mm	x100	
12.163	Ø38mm	x100	



METAL RING



RINGS DETAILS		INFORMATION	DIMENSIONS *mm	
		<p>This oval white plastic ring is available in 50mm and 20mm length. It features a click closing for a better attachment. It is ideal for hanging signage, baskets and objects at retail stores or at the supermarkets.</p>		REF 12.158
	REF 12.380			
ROUND RING	DIAMETER			
12.380	50mm	x100 		
12.158	20mm	x200 		

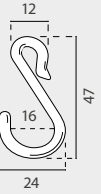

OVAL PLASTIC RING



HOOK DETAIL		INFORMATION	DIMENSIONS *mm	
		<p>This white plastic hook is 47mm length. It features an "S" shape for 2 diameters for being used with 6mm and 16mm wire. It is ideal for hanging signage, baskets and objects at retail stores or at the supermarkets.</p>		
47 "S"	SIZE			
12.377	24x47mm	x100 		



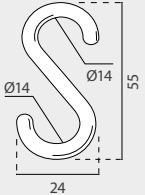

STRIP PLASTIC HOOK



HOOK DETAIL		INFORMATION	DIMENSIONS *mm	
		<p>This white plastic hook is 55mm length. It features an "S" shape for 2 diameters for being used with wires up to Ø14mm. It is ideal for hanging signage, baskets and objects at retail stores or at the supermarkets.</p>		
55 "S"	SIZE			
12.293	24x55x5mm	x100 		

"S" PLASTIC HOOK



RINGS DETAILS		INFORMATION	DIMENSIONS *mm	
		<p>This light round white plastic ring closes easily thanks its click system. Featuring 2 diameters of ring available (15mm or 23mm). They are ideal for hanging signage, baskets or objects at retail stores or at the supermarkets.</p>		REF 12.159
	REF 12.304			
ROUND RING	DIAMETER			
12.159	Ø 15mm	x100 		
12.304	Ø 23mm	x100 		

PLASTIC RING



PRONG DETAIL INFORMATION DIMENSIONS *mm

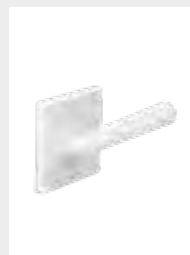

This 43mm length prong has a 25x28mm adhesive pad so it is ideal for presenting last minute add-on items, also is perfect for presenting gift cards, hanging posters or promotional showcards on your cardboard display.

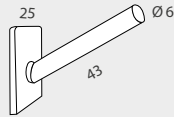

PLASTIC PRONG SIZE

12.485	28x25x43mm	x100 
--------	------------	--

SMALL PLASTIC PRONG





HOOKS DETAILS INFORMATION DIMENSIONS *mm

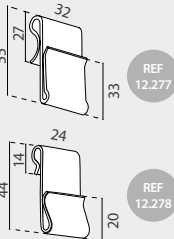

The white double Clip Hook is suitable for cardboard, wire, glass... Ideal for representing last minute add-on items or adding promotional products on your display. 2 sizes of clip available.



DOUBLE CLIP LENGTH

12.277	55mm	x100 
12.278	44mm	x100 

DOUBLE COUPON HOOK



HOOK DETAIL INFORMATION DIMENSIONS *mm



Clip-on over cardboard displays. "S" Hook is ideal for presenting last minute add-on items, also for presenting gift cards or adding promotional products on your display.

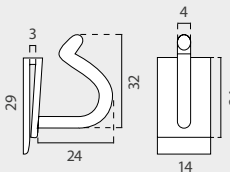

HOLDER "S" HOOK SIZE

12.074	24x32mm	x100 
--------	---------	--

"S" COUPON HOOK



HOOK DETAIL INFORMATION DIMENSIONS *mm



Clip-on over cardboard displays. "D" Hook is ideal for presenting last minute add-on items, also for presenting gift cards or adding promotional products on your display.

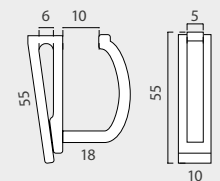

HOLDER "D" LENGTH

12.279	55mm	x100 
--------	------	--

"D" COUPON HOOK

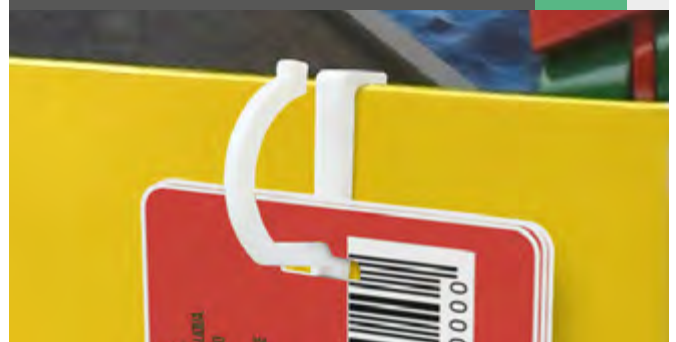

CLIP DETAIL **INFORMATION** **DIMENSIONS** *mm



This 27x10mm metallic clip with hole features a strength clamp. This clip is ideal for holding offer posters, shopping signage or promotional banners, at any point of sale.



METAL CLIP	SIZE		
12.164	10x27mm	x100	

METAL CLIP







CLIPS DETAIL **INFORMATION** **DIMENSIONS** *mm

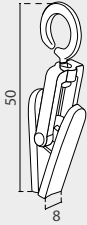

Ring Clip is made of plastic and features an open ring for being used on wires. 2 colors of clip available (black and transparent). Ideal to hang removable signage.



RING CLIP	SIZE		
12.374	 50x8mm	x100	
12.375	 50x8mm	x100	

RING CLIP





CLAMP DETAIL **INFORMATION** **DIMENSIONS** *mm



The Open Ring Clamp is made of plastic and it is available in 2 colors. It is ideal for holding signage, offer posters or shopping promotions at supermarkets, stores or at any point of sale.



OPEN RING	SIZE		
12.476	 14x70mm	x50	
12.477	 14x70mm	x50	

OPEN RING CLIP



CLAMP DETAIL **INFORMATION** **DIMENSIONS** *mm



This big transparent clamp features 2 rotary axes for displaying several angles of vision, also a strength 60mm clamp which is ideal for holding signage, offer posters or shopping promotions at supermarkets, stores or at any point of sale.



ROTATING HOOK	SIZE		
12.475	60x110mm	x50	

ROTATING HOOK CLAMP



HOLDER DETAILS

DIMENSIONS *mm

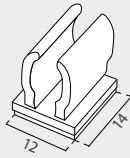

INFORMATION

This 12x14mm holder with adhesive base is suitable for standard pens or pencils. Quick and simple use. Ideal for the academies, schools or for the offices...

PEN CLAMP	BASE SIZE	
12.182	12x14mm	x100 

PEN CLIP HOLDER

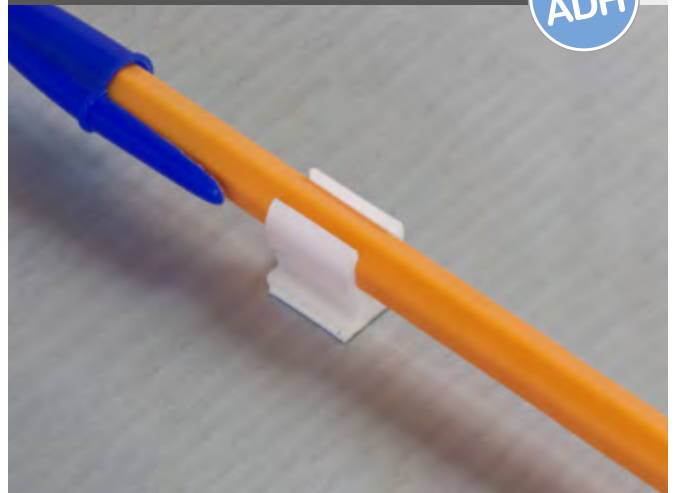

HOLDER DETAILS

DIMENSIONS *mm

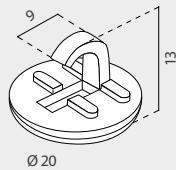

INFORMATION

This pen or cable white holder features a Ø20mm rounded adhesive base. It is also suitable for the most pens and pencils (up to Ø8mm).

PEN GUIDE	BASE SIZE	
12.448	Ø20mm	x100 

PEN GUIDE HOLDER

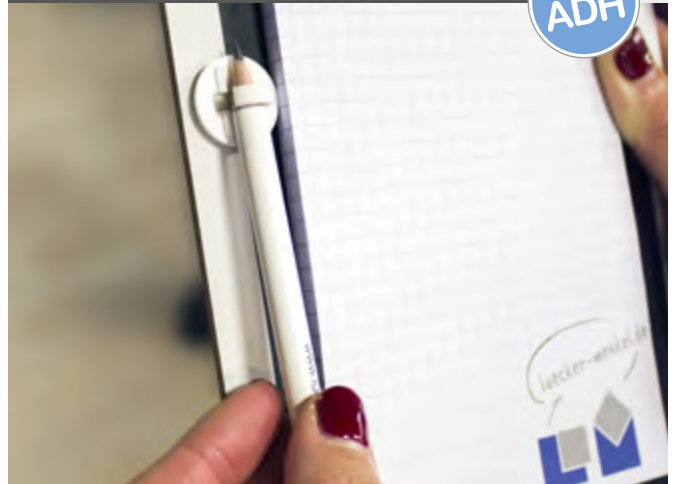

HOLDERS DETAILS

DIMENSIONS *mm

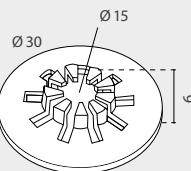

INFORMATION

This CD holder has a Ø30mm rounded adhesive base. 3 different colors available.

CD HOLDER	COLOR	DIAMETER	
12.486	 White	Ø30mm	x100 
12.487	 Clear	Ø30mm	x100 
12.488	 Black	Ø30mm	x100 

CD HOLDER



DISCS DETAILS



INFORMATION

These adhesive adjustable tape discs are easy to use and they are durable and strong. Allows an easily changing of signage position thanks its male and female genuine VELCRO® brand sides. 3 diameters available. Ideal for being used with paper crafts, cardboard or displays.

TAPE DISCS	DIAMETER		
12.505	♂ 10mm	x1000 	
12.506	♀ 10mm		
12.507	♂ 20mm	x1000 	
12.508	♀ 20mm		
12.509	♂ 25mm	x1000 	
12.510	♀ 25mm		

ADJUSTABLE TAPE DISCS





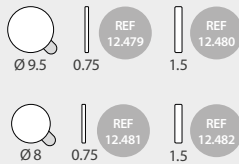
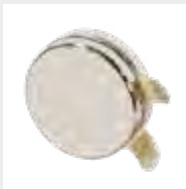

DISC DETAILS

DIMENSIONS *mm



INFORMATION

This double magnetic disc has adhesive on the back and it is ideal as fastener.

ADHESIVE DISC	SIZE		
12.479	Ø9.5x0.75mm	x100 	
12.480	Ø9.5x1.5mm	x100 	
12.481	Ø8x0.75mm	x100 	
12.482	Ø8x1.5mm	x100 	

DOUBLE MAGNETIC DISC



TETHER DETAILS

DIMENSIONS *mm

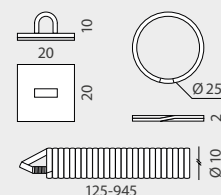

INFORMATION

A low cost, elastic holder for graphics. 2 rings and 2 adhesive pads are included.

TETHER	CABLE LENGTH	MAXIMUM LENGTH	
12.539	125-945mm	1000mm	x50 

COILED TETHER



TIE DETAILS



INFORMATION

*mm

This transparent cable tie holder is made of plastic and it is ideal for attaching price labels on wire shelves or promotion card to displays. It has 55mm length.

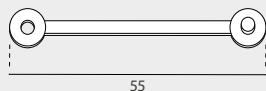

CABLE TIE	LENGTH		
12.376	55mm	x100	

CABLE TIE

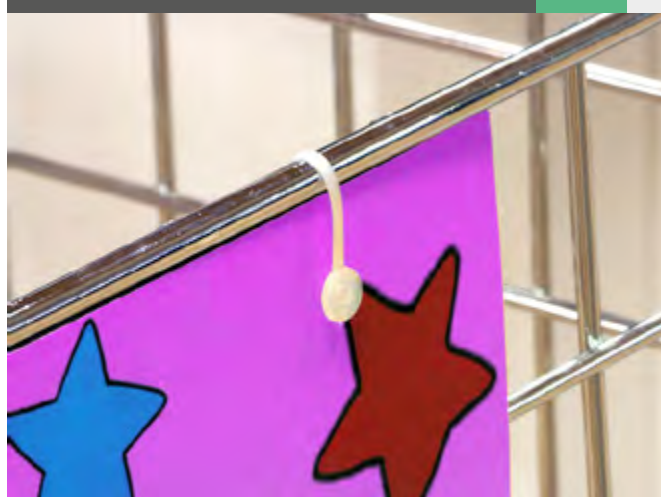

CORD DETAILS



INFORMATION

*mm

Ø2.5mm black elastic cord with metal ends, ideal for attaching promotion cards or price labels.



ELASTIC CORD	SIZE		
12.502	Ø 2.5x100mm	x100	
12.503	Ø 2.5x150mm	x100	
12.504	Ø 2.5x200mm	x100	

ELASTIC CORD



CHAIN DETAILS



INFORMATION

Ø2.4mm ball chain available in 3 lengths. It is ideal for hanging posters, for poster rails or attaching promotion cards and price labels to the products.

BALL CHAIN	SIZE		
12.489	Ø 2.4x100mm	x50	
12.490	Ø 2.4x500mm	x50	
12.491	Ø 2.4x1000mm	x50	

BALL CHAIN

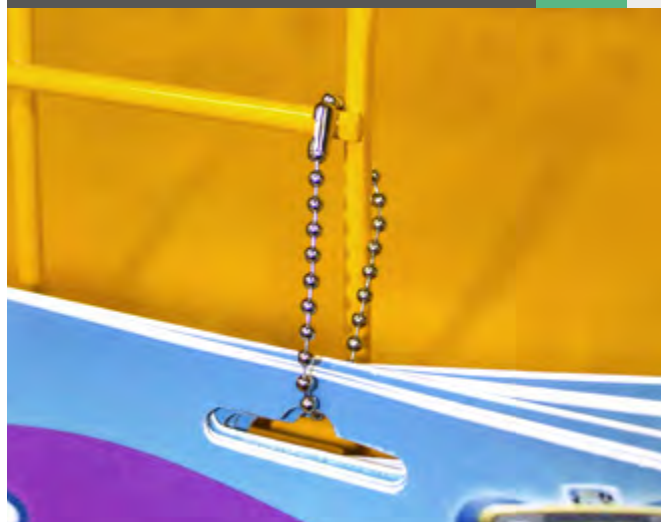

LOOP PIN DETAILS

INFORMATION

*mm



LENGTH



This flexible and easily adjustable plastic loop pin is beaded for an easy adjustment. It is ideal for attaching the price labels directly to the products.

PLASTIC STRAP	LENGTH		
12.497	3" (76.20mm)	x1000	
12.498	4" (101.60mm)	x1000	
12.499	5" (127.00mm)	x1000	
12.500	6" (152.40mm)	x1000	
12.501	7" (177.80mm)	x1000	

PLASTIC BEADED LOOP PIN



LOOP PIN DETAILS

INFORMATION

*mm



LENGTH



This flexible and easily adjustable plastic loop pin is one of the most used attaching systems at retail stores. It is ideal for attaching the price labels directly to the products.

BEADED STRAP	SIZE		
12.492	3" (76.20mm)	x1000	
12.493	4" (101.60mm)	x1000	
12.494	5" (127.00mm)	x1000	
12.495	6" (152.40mm)	x1000	
12.496	7" (177.80mm)	x1000	

PLASTIC LOOP PIN





PULL BOX DETAILS

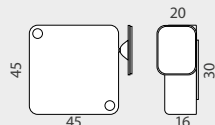

INFORMATION

This pull box features a retractable metallic cable and an adhesive plate with a retractable cable from 0 to 1000mm of length. Ideal as an anti thieves resource in supermarkets or retail stores.



CABLE LENGTH			
50.571	1000mm	x25	

RETRACTABLE PULL BOX



HANGING SOLUTIONS Ceiling Hooks

Full range of **hanging solutions** with different attachment systems like magnets, adhesives, suction cups, clips, etc... Ideal for displaying **signage** from **ceiling** in high traffic areas at point of sale.

BUTTON DETAILS





INFORMATION

*mm

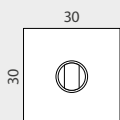
This low cost white polypropylene ceiling button has a rotating closed hook and self adhesive foam for a fast application. It is squared and 10mm height. Also, it accepts Ø5mm wire hooks. Ideal for attaching promotions from the ceiling.



360° SQUARED SIZE

12.113 30x30mm x100  

360° ADHESIVE SQUARED BUTTON



BUTTON DETAILS



INFORMATION

*mm

This low cost white polypropylene ceiling button features a rotating closed hook and self adhesive foam side for a fast application. It is 25mm height. Also, it accepts 6mm diameter wire hooks. Ideal for attaching promotions from the ceiling.

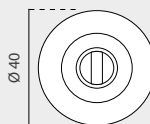

360° ROUNDED DIAMETER

12.384 Ø40mm x100  

360° ADHESIVE ROUNDED BUTTON



BUTTON DETAILS

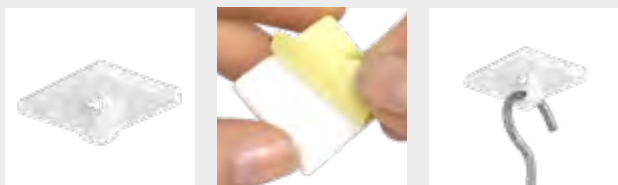

INFORMATION

*mm

This low cost white polypropylene ceiling button features a closed hook and self adhesive foam side for a fast application. It is squared and it is 10mm height. Also, it accepts 5mm diameter wire hooks. Ideal for attaching promotions from the ceiling.

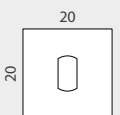

SQUARED SIZE

12.129 20x20mm x100 

ADHESIVE SQUARED BUTTON



BUTTON DETAILS

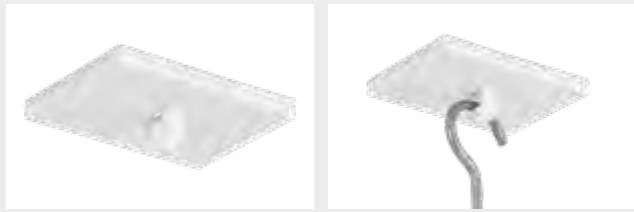

INFORMATION

*mm

This low cost white polypropylene ceiling button features a closed hook and self adhesive foam side for a fast application. It is squared and it is 10mm height. Also, it accepts 5mm diameter wire hooks. Ideal for attaching promotions from the ceiling.

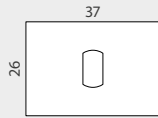

RECTANGULAR SIZE

12.130 37x26mm x100 

ADHESIVE RECTANGULAR BUTTON



BUTTON DETAILS



INFORMATION

*mm

This low cost white polypropylene ceiling button features a closed hook and self adhesive foam side for a fast application. It is rounded and it is 9mm height. Also, it accepts 5mm diameter wire hooks. Ideal for attaching promotions from the ceiling.

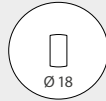

ROUNDED DIAMETER

12.301 Ø18mm x100 

ADHESIVE ROUNDED BUTTON



BUTTON DETAILS



INFORMATION

*mm

This low cost white polypropylene ceiling button features a closed hook and self adhesive foam side for a fast application. It is oval and it is 9mm height. Also, it accepts 5mm diameter wire hooks. Ideal for attaching promotions from the ceiling.

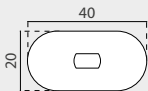

OVAL SIZE

12.368 40x20mm x100 

ADHESIVE OVAL BUTTON



HOOK DETAIL

DIMENSIONS *mm



INFORMATION

Squared adhesive button and open hook. Ideal for attaching wires from ceiling.

STRAIGHT SIZE

12.131 24x24mm x100 

ADHESIVE STRAIGHT HOOK



BUTTON DETAIL

DIMENSIONS *mm



INFORMATION

Squared adhesive button with open ring hook. Ideal for attaching from ceiling.

RING SIZE

12.447 25x25mm x100 

ADHESIVE RING BUTTON



CLIP DETAIL

DIMENSIONS *mm



INFORMATION

Transparent Clip with hole for wire hooks. Ideal for attaching wires from ceiling.

VERTICAL SIZE

12.132 23x20mm x100 

CEILING VERTICAL CLIP



CLIP DETAIL

DIMENSIONS *mm



INFORMATION

Transparent clip with close Ø5mm hook. It is ideal for attaching wires from ceiling.

HORIZONTAL SIZE

12.133 20x20mm x100 

CEILING HORIZONTAL CLIP



HOOK DETAILS

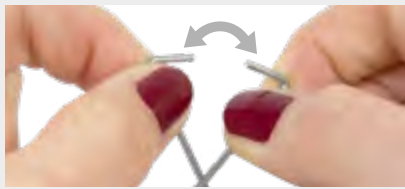

INFORMATION

*mm

This silver clip with fish shape is ideal for holding promotions, offers, banner posters or signage with wire hooks from the ceiling.



FISH HOOK

SIZE

12.136

65x29mm

x100 

FISH HOOK



HOOK DETAILS



INFORMATION

*mm

This wire clip, thanks to its shape is ideal for holding promotions, offers, banner posters or signage with wire hooks from ceiling.



SPIDER HOOK

SIZE

12.135

75x20mm

x100 

SPIDER HOOK

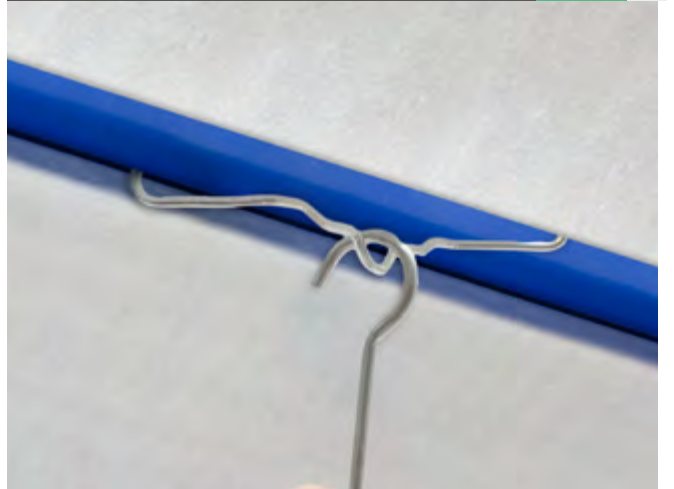

HOOK DETAILS

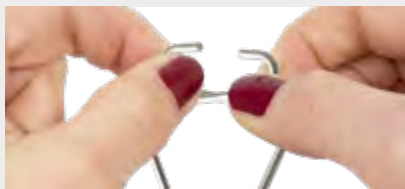

INFORMATION

*mm

This silver clip with bat shape is ideal for holding promotions, offers, banner posters or signage with wire hooks from the ceiling.

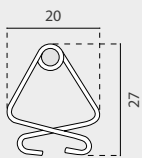

BAT HOOK

SIZE

12.387

20x27mm

x100 

BAT HOOK





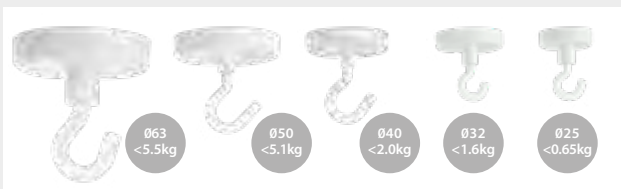

HOOK DETAILS



INFORMATION

This magnetic round base has rounded opening hook. With 5 sizes. They are suitable with any kind of metallic furniture. Ideal to hang promotions from the ceiling.

ROUND BASE	DIAMETER	WEIGHT SUPPORTED	
12.167	Ø25mm	<650 g	x25 
12.347	Ø32mm	<1600 g	x20 
12.348	Ø40mm	<2000 g	x10 
12.349	Ø50mm	<5100 g	x10 
12.350	Ø63mm	<5500 g	x10 

ROUND BASE MAGNETIC HOOK

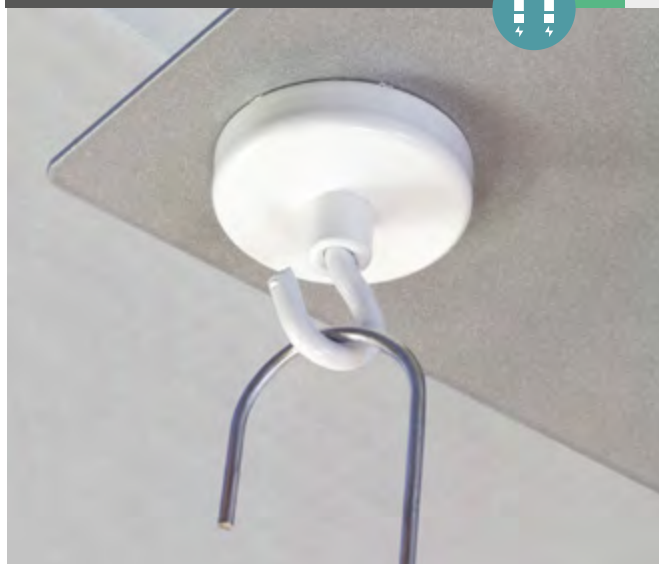

HOOK DETAILS

DIMENSIONS *mm



INFORMATION

This Ø24mm white round base is made of steel with neodymium core. It's suitable with any kind of metallic surface thanks to its magnetic neodymium strength.

NEODYMIUM	DIAMETER	HEIGHT	
80403001	Ø24mm	23mm	x50 

ROUND BASE NEODYMIUM HOOK

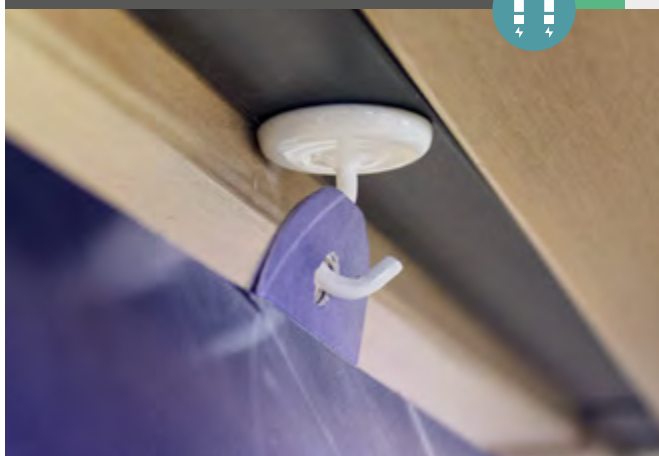

HOOK DETAILS

DIMENSIONS *mm



INFORMATION

The 28x14mm magnetic base with 13mm high closed hook is suitable for attaching promotional banners or supermarket poster on any kind of metal surface.

BRICK MAGNET	SIZE	
12.478	28x14x38mm	x50 

BRICK BASE MAGNETIC HOOK

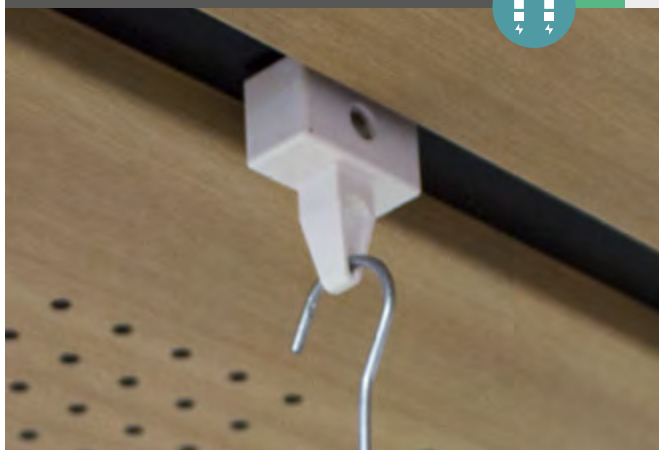

HOOK DETAILS

DIMENSIONS *mm

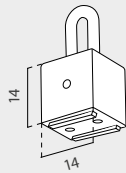

INFORMATION

This magnetic cube with closed hook is ideal for hanging promotions from ceiling.

SQUARE SIZE

12.165 14x14mm x50 

SQUARE BASE MAGNETIC HOOK



HOOK DETAILS

DIMENSIONS *mm

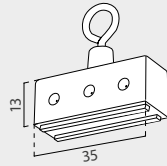

INFORMATION

This magnetic base with closed hook is ideal for hanging promotions from ceiling.

RECTANGLE SIZE

12.166 35x13mm x50 

RECTANGLE BASE MAGNETIC HOOK



HOOK DETAILS

DIMENSIONS *mm

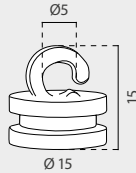

INFORMATION

This small magnetic open hook is ideal for hanging promotions from ceiling.

OPEN MINI SIZE

12.386 Ø15x15mm x50 

MINI OPEN MAGNETIC HOOK



HOOK DETAILS

DIMENSIONS *mm

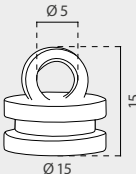
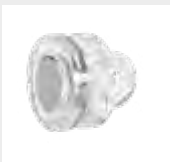

INFORMATION

This small magnetic closed hook is ideal for hanging promotions from ceiling.

CLOSED MINI SIZE

12.385 Ø15x15mm x50 

MINI CLOSED MAGNETIC HOOK

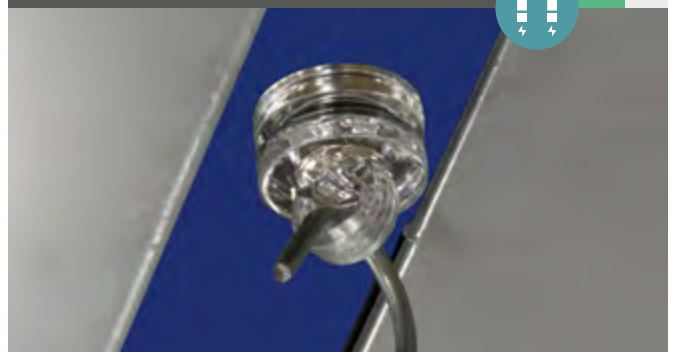

HOOK DETAILS

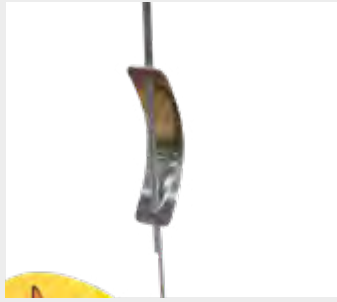
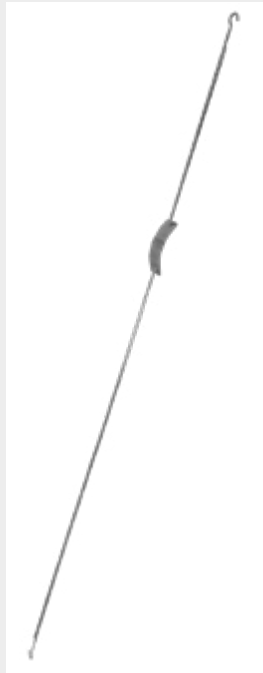

INFORMATION

*mm

This metallic with silver finish Hook features an adjustable length system which allows a maximum length of 2000mm. Made of steel, this hook is ideal for being used for displaying large offer banners, temporary sales or banners from the ceiling at the supermarkets, at retail stores or at malls.

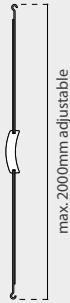

ADJUSTABLE	LENGTH	
12.151	1000-2000mm	x50 

ADJUSTABLE METAL HOOK



HOOKS DETAILS

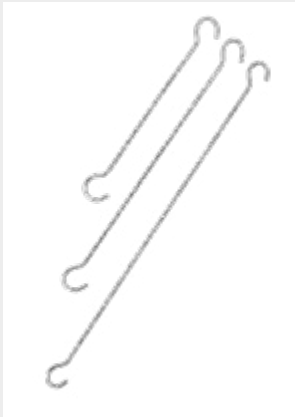











INFORMATION

*mm

This bright and galvanised double hook features 10 sizes available. Ideal for displaying offers, sales or temporary banners from the ceiling at retail stores supermarkets or malls.



DOUBLE	SIZE	
12.141	100mm	x50 
12.142	150mm	x50 
12.143	200mm	x50 
12.144	300mm	x50 
12.145	400mm	x50 
12.146	500mm	x50 
12.147	600mm	x50 
12.148	750mm	x50 
12.149	900mm	x50 
12.150	1000mm	x50 

DOUBLE METAL HOOK



HOOK DETAILS



INFORMATION

*mm

This silver finish metallic hook features an adjustable length system thanks its highly resistant nylon wire wich allows a maximum length of 1200mm, so this hook is ideal for displaying large offer banners, or temporary sales from the ceiling at the retail stores.

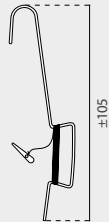

NYLON

12.137

x100 

METAL HOOK WITH NYLON WIRE

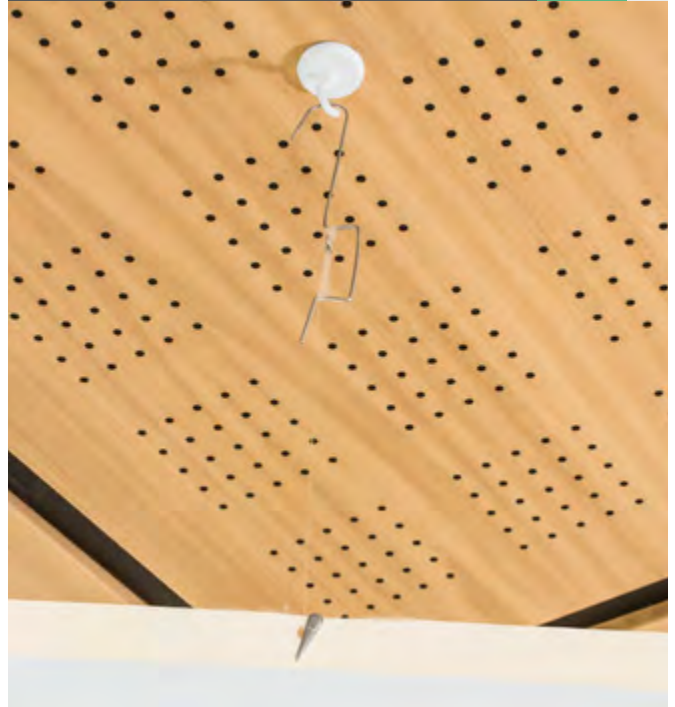

HOOK DETAILS



INFORMATION

*mm

This metallic Hook features an extendible spring system. Made of steel, and with 3 lengths available. This hook is ideal for being used for displaying large offer banners, temporary sales or banners from the ceiling at the supermarkets, at retail stores or at malls.



EXTENDIBLE

12.138	160 - 1300mm	x100 
12.139	210 - 1400mm	x100 
12.140	320 - 2500mm	x100 

EXTENDIBLE WIRE HOOK

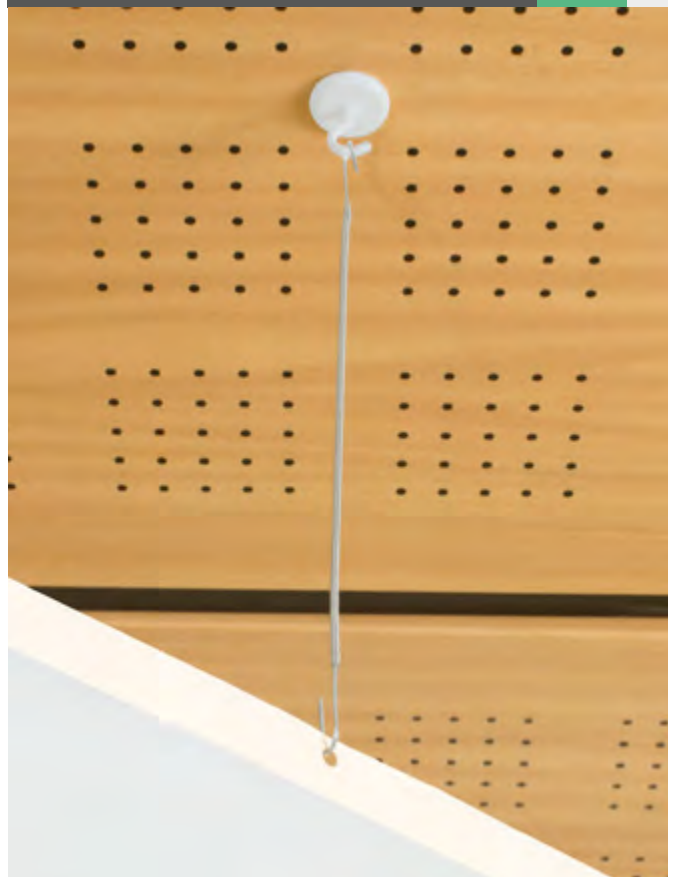

FIXING SPEARS DETAILS

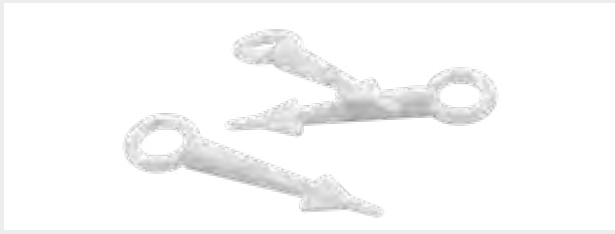

INFORMATION

*mm

The fixing spears are made of lightweight plastic, using it with nylon wire (not included) they are an easy solution for hanging promotional offers from ceiling. Also thanks to its design they are ideal for being used with foamboards signages.

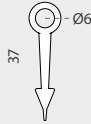

FIXING SPEARS	LENGTH		
12.538	37mm	x100	

FIXING SPEARS



NYLON LINE DETAIL



INFORMATION

This nylon line is ideal for attaching promotional signage from the ceiling.

NYLON LINE	LENGTH	DIAMETER	
12.373	5m	0.5mm	x100 

NYLON LINE

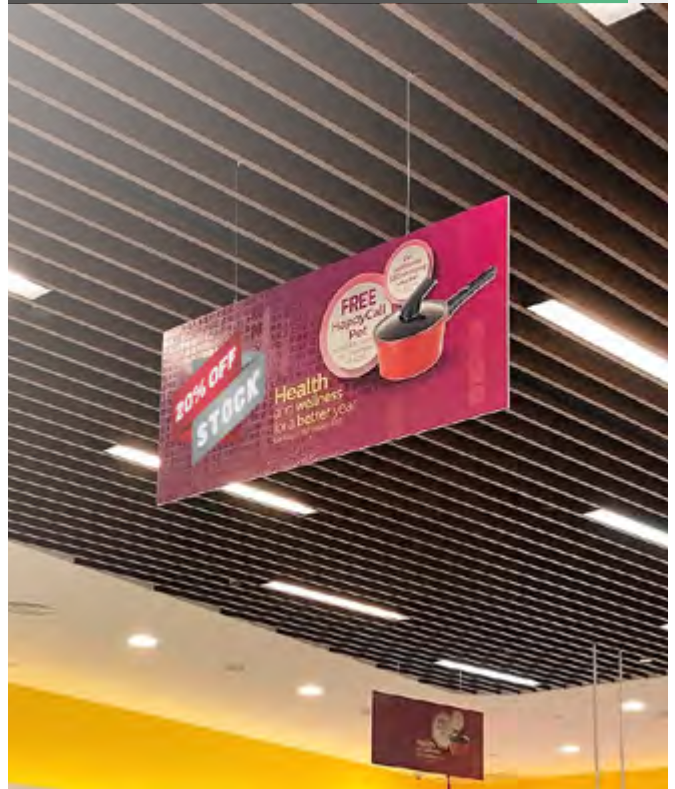

SUCTION CUP DETAILS

DIMENSIONS *mm



INFORMATION

With double Ø45mm suction cup for an reinforced attachment. For flat surfaces.

D. THUMB TACK	DIAMETER	
12.171	Ø45mm	x100 

DOUBLE SUCTION CUP WITH THUMB TACK

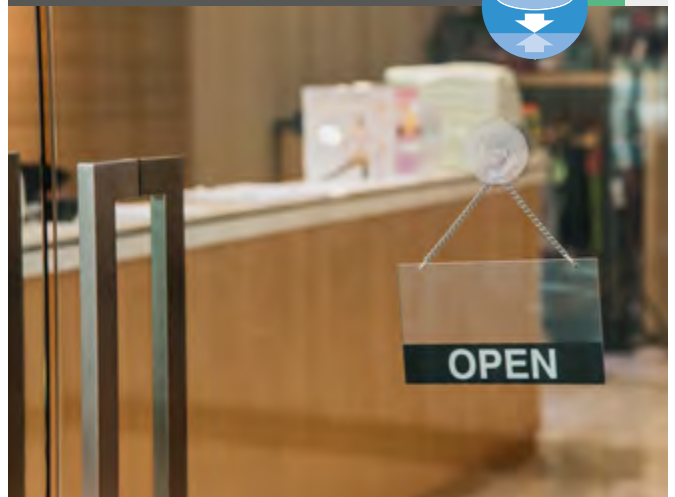

SUCTION CUP DETAILS

DIMENSIONS *mm

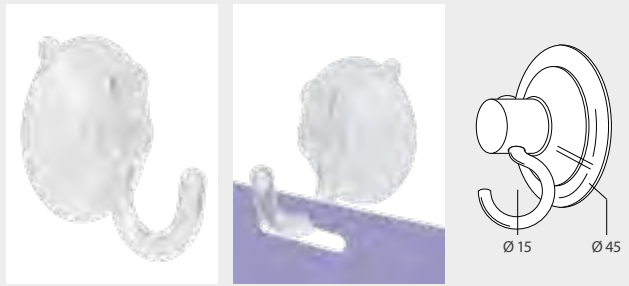

INFORMATION

With double Ø45mm suction cup for an reinforced attachment. For flat surfaces.

DOUBLE	DIAMETER	
12.172	Ø45mm	x100 

DOUBLE SUCTION CUP WITH PLASTIC HOOK

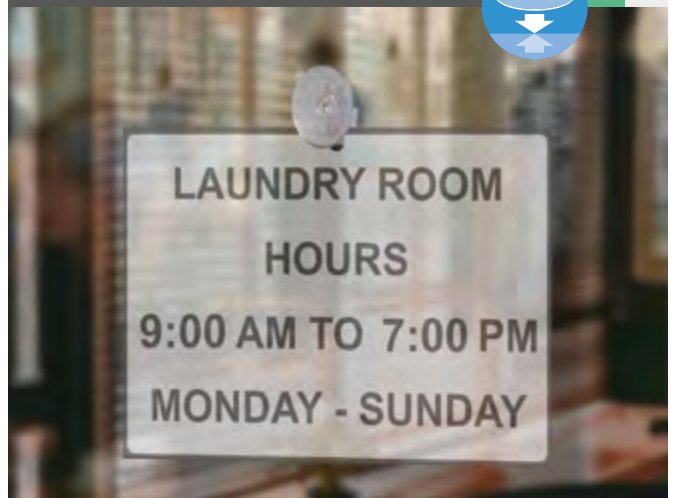

SUCTION CUP DETAILS

DIMENSIONS *mm



INFORMATION

This suction cup has a double suction for a reinforced fixing. With a front thumbtack.

DOUBLE	DIAMETER	
12.472	Ø35mm	x100 

DOUBLE SUCTION CUP

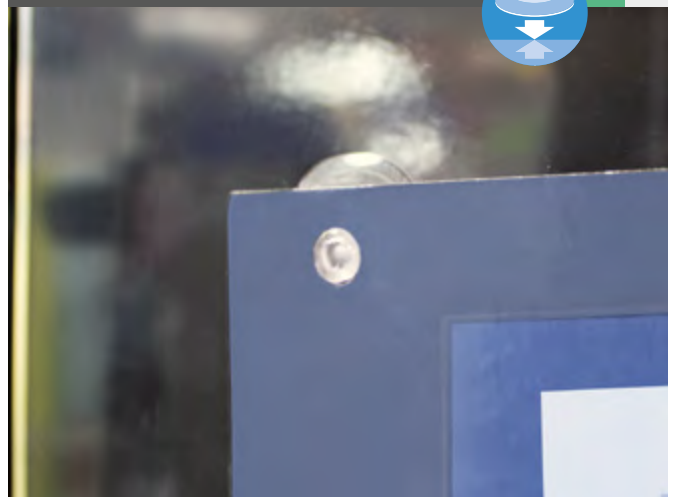

SUCTION CUPS Suction Cups

SUCTION CUP DETAILS

DIMENSIONS *mm

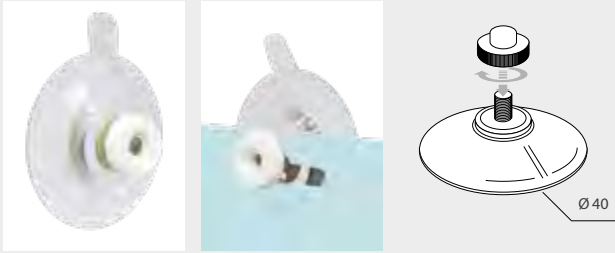

INFORMATION

Ø40mm diameter suction cup with removable screw for a reinforced fastening.

WITH SCREW	DIAMETER	
12.388	Ø40mm	x100 

SUCTION CUP WITH SCREW



SUCTION CUP DETAILS

DIMENSIONS *mm

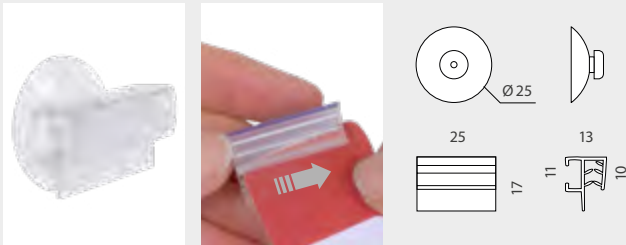

INFORMATION

Suction cup with lateral gripper that allows the insertion of cards up to 3mm thickness. Ideal for price labels or promotions on shelving.

LATERAL GRIP	DIAMETER	
12.200	Ø25mm	x100 

LATERAL GRIPPER SUCTION CUP

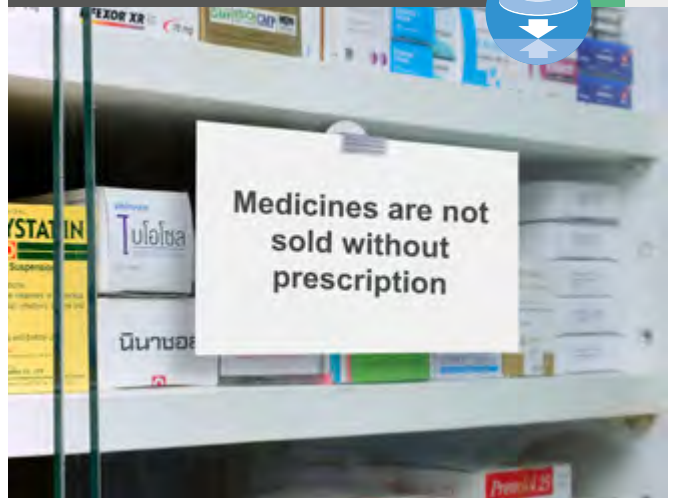

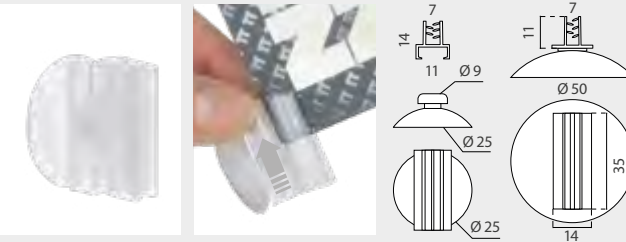

SUCTION CUP DETAILS

DIMENSIONS *mm



INFORMATION

Suction cup with front gripper that allows the insertion of cards up to 3mm thickness. Ideal for price labels or promotions on shelving.

FRONT GRIP	DIAMETER	
12.201	Ø25mm	x100 
12.473	Ø50mm	x100 

FRONT GRIPPER WITH THUMB TACK



SUCTION CUPS Suction Cups

SUCTION CUP DETAILS

INFORMATION *mm

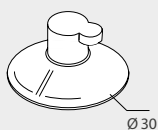

This transparent suction cup sticks to glass or any smooth surface. Good adhesion due to the quality of the molding. It features a plastic hook.

PLASTIC HOOK

DIAMETER

12.168

Ø30mm

x100 

SUCTION CUP WITH PLASTIC HOOK

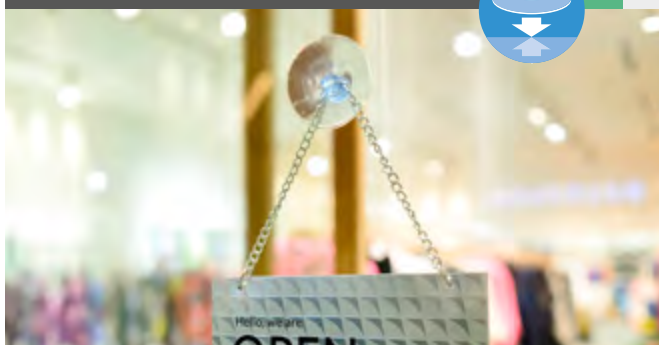

SUCTION CUP DETAILS

INFORMATION *mm

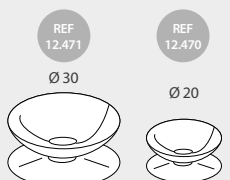
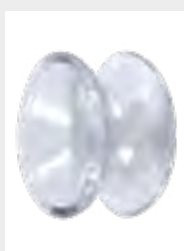

This suction cup has a double suction for a reinforced fixing. With a front cup.

DOUBLE

DIAMETER

12.470

Ø20mm

x100 

12.471

Ø30mm

x100 

DOUBLE SIDED SUCTION CUP



SUCTION CUP DETAILS

INFORMATION *mm

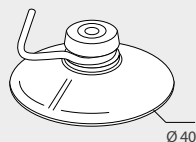
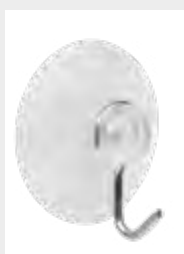

With removable metal hook. Ideal to use directly with the poster, showcard, etc...

METAL HOOK

DIAMETER

12.169

Ø40mm

x100 

SUCTION CUP WITH METAL HOOK

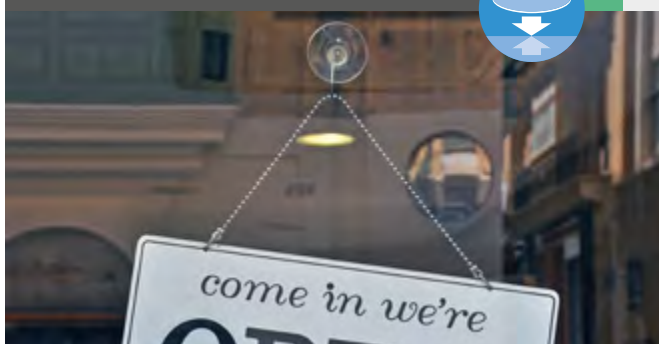

SUCTION CUP DETAILS

INFORMATION *mm

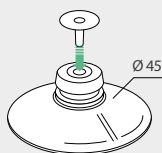

With removable metal hook. Ideal to use directly with the poster, showcard, etc...

THUMBTAKE

DIAMETER

12.170

Ø45mm

x100 

SUCTION CUP WITH THUMBTAKE



SUCTION CUP DETAILS





INFORMATION

DIMENSIONS

*mm

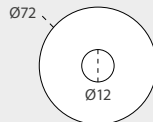
This system allows attach a banner instantly to any window or glass surface, featuring great fixation. 12 units pack. Ideal for boutiques, retail stores or bakeries, for displaying your promos, sales or services right to your storefront window.



BANNER	QTY	N.W	G.W	C.B.M	SIZE
Packing	12	0.4kg	0.45kg	0.04	580x170x40mm
10.798				x12 	

BANNER SUCTION CUPS



SUCTION CUP DETAILS



INFORMATION

DIMENSIONS

*mm

This system features great fixation thanks to its Ø120mm reinforced fixing suction cup. It includes an adjustable holder. It is ideal for holding graphs between 3/10mm thickness.

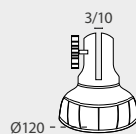

PANEL	QTY	N.W	G.W	C.B.M	SIZE
Packing	1	0.25kg	0.3kg	0.001	125x125x125mm
10.595				Suction Cup Size: Ø120mm	

PANEL BANNER SUCTION CUP



SUCTION CUP DETAILS



INFORMATION

DIMENSIONS *mm

This system features great fixation thanks its Ø65mm suction cup. The application is really easy, just peel off the adhesive with one of the genuine VELCRO® brand strip and fix it to the graphic or poster. Next, adjust it with the genuine VELCRO® brand strip of the suction cups. Each pack includes 4 units. Ideal for placements where the graphic changing is often needed and the graphic adjustment with genuine VELCRO® brand strip makes it easy.

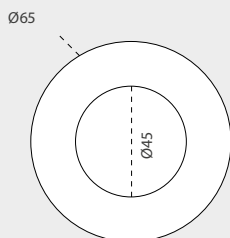

REMOVABLE BANNER SUCTION CUPS



REMOVABLE	QTY	N.W	G.W	C.B.M	SIZE
Packing	4	0.09kg	0.15kg	0.0008	120x80x80mm
10.779	x4 				

* VELCRO® is a registered trademark of Velcro BVBA. | VELCRO® est une marque déposée de Velcro Industries B.V. | VELCRO® é uma marca registrada de Velcro Industries B. V. | VELCRO® es una marca registrada de VelcroIndustries B. V.

GRIPPER DETAILS



INFORMATION

This useful transparent gripper fits onto any support thanks its back adhesive. It allows the insertion of cards up to 3mm thickness. Ideal for displaying messages at the point of sale

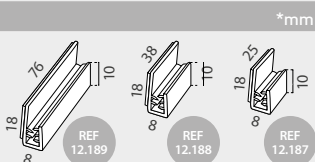

FRONT GRIPPER	LENGTH		
12.187	25mm	x100	
12.188	38mm	x100	
12.189	76mm	x100	

ADHESIVE FRONT GRIPPER FOR PROFILE



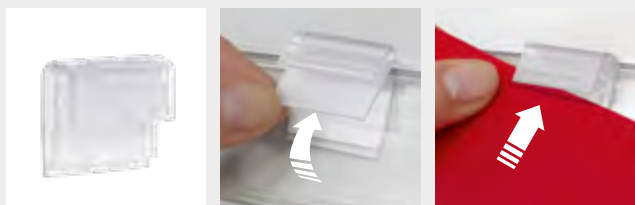

GRIPPER DETAILS

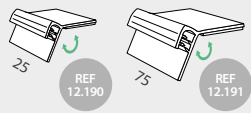

INFORMATION

This transparent gripper fits onto any support thanks its adhesive foampad. With a hinged base for protecting signage against shocks. It allows the insertion of cards up to 3mm thickness. Ideal for displaying extra-information at the POS line.



HINGED GRIPPER	LENGTH		
12.190	25mm	x100	
12.191	75mm	x100	

ADHESIVE HINGED GRIPPER FOR PROFILE





GRIPPER DETAILS

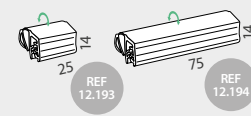

INFORMATION

This transparent front gripper fits into most of shelving profiles. Featuring a hinged base for protecting signage against shocks. It allows the insertion of cards up to 3mm thickness. Ideal for displaying an extra-information at the sale line.



FRONT HINGED	LENGTH		
12.193	25mm	x100	
12.194	75mm	x100	

FRONT HINGED GRIPPER FOR PROFILE



GRIPPER DETAILS



INFORMATION

*mm

This transparent gripper fits into most sides of label-holder profiles up to 3mm. It allows the insertion of cards up to 3mm thickness. Ideal for being used as a side signage stopper.

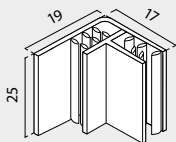

SIDE STOPPER

SIZE

12.453

19x17x25mm

x100 

SIDE STOPPER GRIPPER
FOR PROFILE



GRIPPER DETAILS

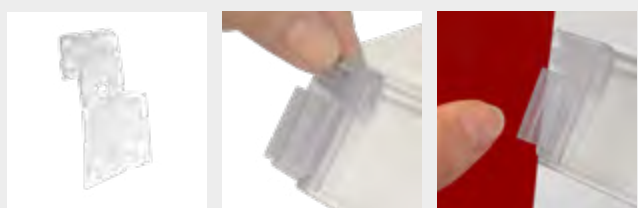

INFORMATION

*mm

This transparent gripper fits into most of label-holder profiles up to 3mm. It allows the insertion of cards up to 3mm thickness. Ideal for being used as a stopper signage support at the sale line.

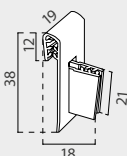

STOPPER GRIPPER

SIZE

12.195

19x38x18mm

x100 

STOPPER GRIPPER
FOR PROFILE



GRIPPER DETAILS

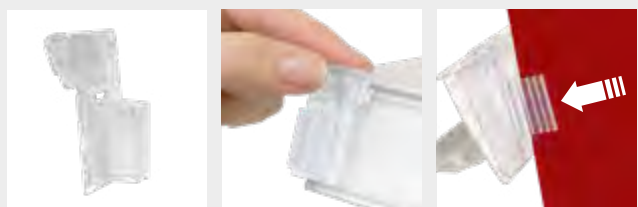

INFORMATION

*mm

This transparent gripper fits into most of shelving profiles. Featuring a hinged base for protecting signage against shocks. It allows the insertion of cards up to 3mm thickness. Ideal for displaying stopper signs, offer messages or price promotions at the sales line.

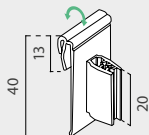

HINGED GRIPPER

HEIGHT

12.192

40mm

x100 

HINGED STOPPER GRIPPER
FOR PROFILE



GRIPPER DETAILS



INFORMATION

*mm

This transparent gripper fits into most of shelving profiles up to 20mm. With a hinged base for protecting signage against shocks. It allows the insertion of cards up to 3mm thickness. Ideal for being used as a stopper signage support at the sale line.

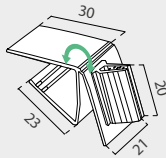

HINGED STOPPER

SIZE

12.523

21x30x20mm

x100



HINGED STOPPER GRIPPER
FOR SHELF



GRIPPER DETAILS



INFORMATION

*mm

This transparent gripper fits into most of shelving profiles. With a hinged base for protecting signage against shocks. It allows the insertion of cards up to 2mm thickness. Ideal for displaying extra-information.

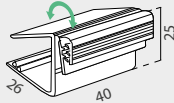

SHELF GRIPPER

LENGTH

12.522

40mm

x100



HINGED FRONT GRIPPER
FOR SHELF



GRIPPER DETAILS

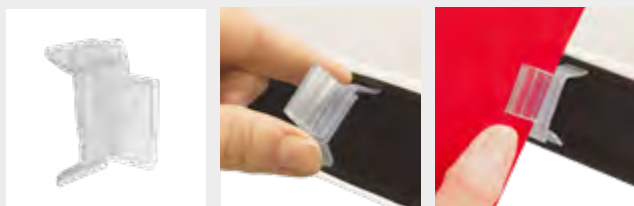

INFORMATION

*mm

This transparent gripper fits into most of label-holder profiles from ±27mm up to ±34mm thanks to its 2 spring clips. It allows the insertion of cards up to 3mm thickness. Ideal for being used as a stopper signage support at the sale line.

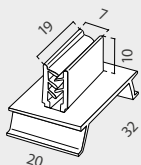

SPRING GRIPPER

BASE SIZE

12.452

20x32mm

x100



SPRING GRIPPER
FOR PROFILE



GRIPPER DETAILS



INFORMATION

*mm

This transparent gripper fits into most of shelving profiles. It allows the insertion of cards up to 3mm thickness. Featuring an adjustable viewing angle. Ideal for displaying stopper signs, offer messages or price promotions at the sales line.

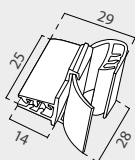

ADJUSTABLE STOPPER

SIZE

12.233

28x29mm

x100



ADJUSTABLE STOPPER GRIPPER FOR PROFILE



GRIPPER DETAILS

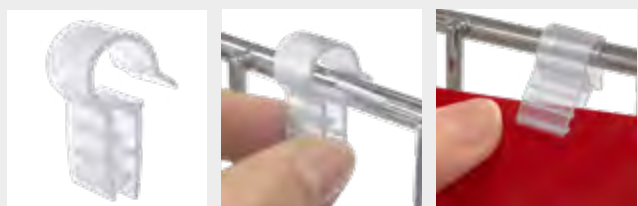

INFORMATION

*mm

This transparent gripper fits into most of wire baskets, or over pole structures up to Ø10mm tubes. It allows the insertion of cards up to 3mm thickness. Ideal as support for displaying signage, light banners or for any promotion at the sale line.

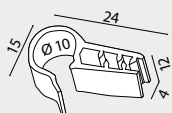

WIRE GRIPPER

SIZE

12.196

12x24x15mm

x100



WIRE GRIPPER



GRIPPER DETAILS



INFORMATION

*mm

This transparent gripper fits onto any support up to 8mm thickness. Also, it allows the insertion of cards up to 3mm thickness. Ideal for attaching signage cards to cardboard displays or to another promotional panel.

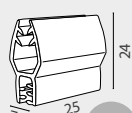

REF 12.369

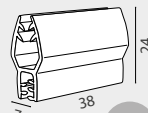

REF 12.370

25 ARROWHEAD

LENGTH

12.369

25mm

x100



38 ARROWHEAD

LENGTH

12.370

38mm

x100



ARROWHEAD GRIPPER



GRIPPER DETAILS



INFORMATION

DIMENSIONS

*mm

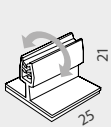

This transparent gripper fits onto any support thanks to its back adhesive foampad. Also, it features a hinged base which protects your promotion card (up to 3mm thickness) against shocks. It is ideal to display messages, signs or promotions at POS.

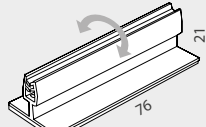

REF 12.382



REF 12.202

HINGED GRIPPER	LENGTH		
12.382	25mm	x100	
12.202	76mm	x100	

HINGED GRIPPER



GRIPPER DETAILS

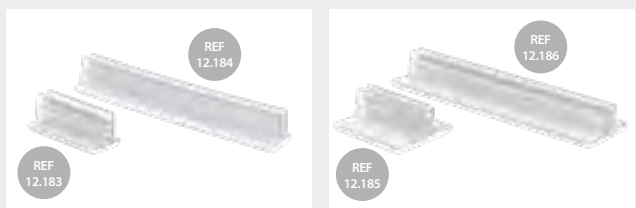

DIMENSIONS

*mm

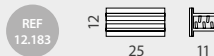

REF 12.183

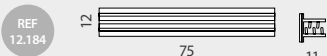

REF 12.184



REF 12.185



REF 12.186

INFORMATION

This basic gripper fits on any support. It has an adhesive back foam pad for an optimum attachment. There are 4 sizes available with transparent finish. Ideal for displaying signs, price labels, messages or for price promotions at sales lines (up to 3mm thickness).

BASIC GRIPPER	BASE SIZE		
12.183	12x25mm	x100	
12.184	12x75mm	x100	
12.185	25x25mm	x100	
12.186	25x75mm	x100	

BASIC GRIPPER



GRIPPER DETAILS



DIMENSIONS

*mm

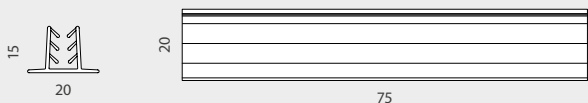

INFORMATION

This adhesive gripper fits on any support. The extra height (15mm) increases the resistance of the grip. Ideal for displaying signs, price cards, messages or labels.

HIGH GRIPPER	SIZE		
12.520	20x75x15mm	x100	

HIGH GRIPPER



DIMENSIONS

*mm

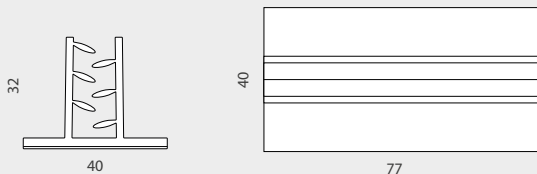

INFORMATION

This Wide Gripper fits on any kind of surface thanks to its adhesive foam pad included. Also its extra width (77mm) provides a solid attachment. Ideal to display signs, messages or price promotions on shelves at sales lines (up to 4mm thickness). With transparent finish.

WIDE GRIPPER	SIZE		
12.346	40x77x32mm	x50	

WIDE GRIPPER



GRIPPER DETAILS



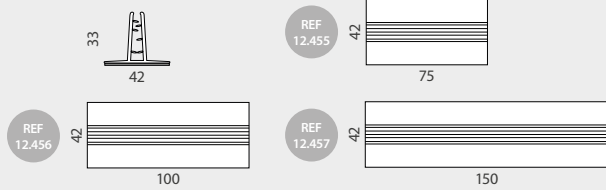

DIMENSIONS

*mm



INFORMATION

The Big Magnetic Gripper fits on any kind of metallic surface. It has a transparent finish. And features 3 widths available. The Big magnetic Gripper is ideal for displaying signs, price labels, messages or price promotions on shelves at the sales lines (up to 5mm thickness).

BIG MAGNETIC	LENGTH	
12.455	75mm	x50 
12.456	100mm	x50 
12.457	150mm	x50 

BIG MAGNETIC GRIPPER



GRIPPER DETAILS



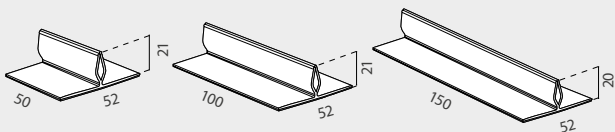

DIMENSIONS

*mm



INFORMATION

The extra size of the Big Gripper provides a solid fixation. It has an adhesive back foam pad for a better fixation and a transparent finish. And features 3 widths available. The Big Gripper is ideal for displaying signs, price labels, messages or price promotions on shelves at the sales lines (up to 2mm thickness).

BIG GRIPPER	LENGTH	
12.378	50mm	x50 
12.379	100mm	x50 
12.383	150mm	x50 

BIG ADHESIVE GRIPPER



GRIPPER DETAIL INFORMATION *mm



This "H" transparent PVC gripper takes up to 2mm thickness cards with 180° angle connection. Ideal for joining cardboard displays, mobiles construction or for displaying signage at POS.

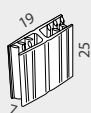

H180 GRIPPER	SIZE		
12.197	19x7x25mm	x100	

"H" 180° GRIPPER



GRIPPER DETAIL INFORMATION *mm



This "V" transparent PVC gripper takes up to 2mm thickness cards with 60° angle connection. Ideal for joining cardboard displays, mobiles construction or for displaying signage at POS.

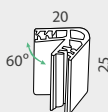

V60 GRIPPER	SIZE		
12.371	20x25mm	x100	

"V" 60° GRIPPER



GRIPPER DETAIL INFORMATION *mm



This "L" transparent PVC gripper takes up to 2mm thickness cards with 90° angle connection. Ideal for joining cardboard displays, mobiles construction or for displaying signage at POS.

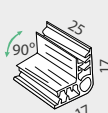

L90 GRIPPER	SIZE		
12.198	17x17x25mm	x100	

"L" 90° GRIPPER



GRIPPER DETAIL INFORMATION *mm



This "Y" transparent PVC gripper takes up to 2mm thickness cards with a 3 ways connection. Ideal for joining cardboard displays, mobiles construction or for displaying signage at POS.

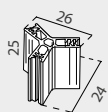

Y GRIPPER	SIZE		
12.372	26x24x25mm	x100	

"Y" GRIPPER

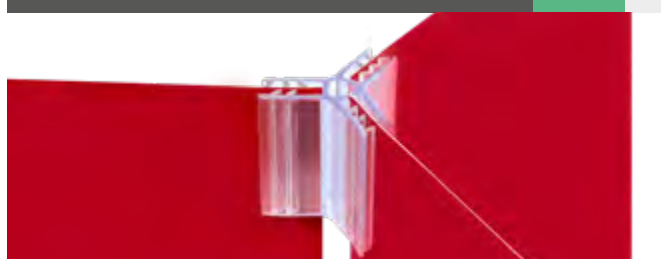

GRIPPER DETAIL INFORMATION *mm



This "X" transparent PVC gripper takes up to 2mm thickness cards with a 4 ways connection. Ideal for joining cardboard displays, mobiles construction or for displaying signage at POS.

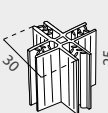

X GRIPPER	SIZE		
12.199	30x30x25mm	x100	

"X" GRIPPER





CONNECTOR DETAILS

INFORMATION

*mm

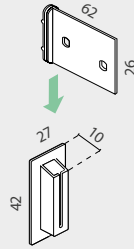

Two interlocking connector pieces for bonding into corrugated cardboard, which are designed for a solid and great supporting on shelf. Also allows an easy flat pack distribution. Ideal for the construction of cardboard displays.

C-27x42x62 PLATE SIZE BASE SIZE

12.517 62x26mm 27x42mm x100

CARDBOARD CONNECTOR

62x26mm PLATE



CONNECTOR DETAILS

INFORMATION

*mm

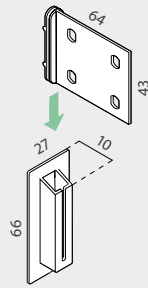

Two interlocking connector pieces for bonding into corrugated cardboard, which are designed and great supporting on shelf. Also allows an easy flat pack distribution.

C-27x66x64 PLATE SIZE BASE SIZE

12.516 64x43mm 27x66mm x100

CARDBOARD CONNECTOR

64x43mm PLATE



CONNECTOR DETAILS

INFORMATION

*mm

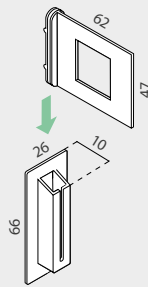

Two interlocking connector pieces for bonding into corrugated cardboard, which are designed and great supporting on shelf. Also allows an easy flat pack distribution.

C-26x66x62 PLATE SIZE BASE SIZE

12.515 62x47mm 26x66mm x100

CARDBOARD CONNECTOR

62x47mm PLATE



CLIP DETAIL **INFORMATION** **DIMENSIONS** *mm



Transparent PVC clip for quick and secure corrugated shelf construction by slotting into die cut holes.



BRACKET	SIZE	QUANTITY			
12.514	38x60x27mm	x100			

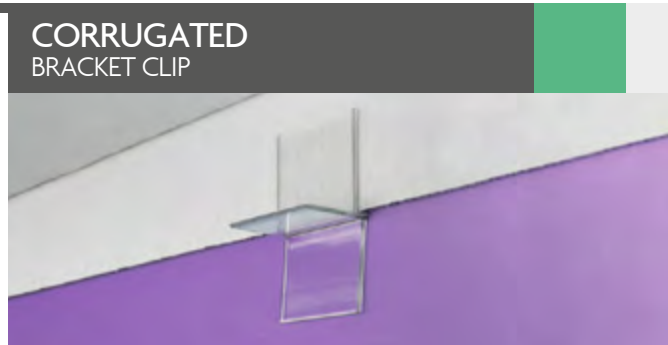

CLIP DETAIL **INFORMATION** **DIMENSIONS** *mm



Transparent and reinforced clip for quick and secure, high strength corrugated shelf construction by slotting into die cut holes.



REINFORCED	SIZE	QUANTITY			
12.513	37x58x34mm	x100			



CASTER DETAIL **INFORMATION** **DIMENSIONS** *mm



Caster rises the cardboard display to avoid the contact with the ground and also enables easy moving of the cardboard display. Fast assembly with clip on bottom of cardboard display.

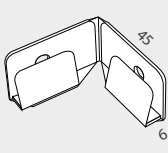

SIMPLE	CORNER LENGTH	QUANTITY			
12.286	45x45mm	x100			



CASTER DETAIL **INFORMATION** **DIMENSIONS** *mm



This caster feet rises display from ground extending the life of usage. It enables easy moving of cardboard display. Easy assembly with clip on bottom of cardboard display.



CLIP	HEIGHT	QUANTITY			
12.518	49mm	x100			



CASTER DETAIL **INFORMATION** **DIMENSIONS** *mm



This caster rises the cardboard display 23mm from the ground and protects it from damaging, featuring a 50x50mm adhesive foam. It also enables easy moving of display. Fast assembly.



ADHESIVE	SIZE	QUANTITY			
12.287	50x50x23mm	x100			



CARDBOARD ACCESSORIES Rivets | Screws

INFORMATION

We provide an excellent selection of fasteners, such as plastic bolts, nuts or screws for the signage attachment and other applications.

Plastic rivet fasteners have numerous applications and come in a wide variety of styles, sizes, and configurations to accommodate different panel dimensions.





12.283 $\varnothing 15$ | $\varnothing 5$ mm 5.5mm x100 

12.285 $\varnothing 29$ | $\varnothing 6$ mm 26mm x100 

12.367 $\varnothing 15$ | $\varnothing 5$ mm 17mm x100 

12.114 $\varnothing 30$ | $\varnothing 5$ mm 12mm x100 

12.469 $\varnothing 16$ | $\varnothing 6$ mm 7mm x100 

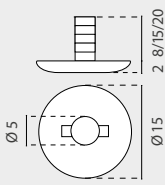

50.111 $\varnothing 6.2$ | $\varnothing 4.6$ mm 9.5mm x100 

CARDBOARD ACCESSORIES Rivets | Screws





screw 



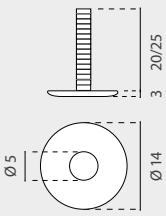

12.466	Ø 15 Ø 5mm	8mm	x100 
12.467	Ø 15 Ø 5mm	15mm	x100 
12.468	Ø 15 Ø 5mm	20mm	x100 





screw 



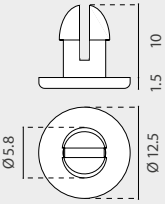

12.463	Ø 14 Ø 5mm	20mm	x100 
12.464	Ø 14 Ø 5mm	25mm	x100 





push 



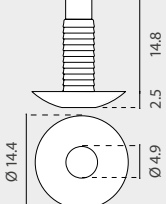

12.521	Ø 12.5 Ø 5.8mm	10mm	x100 
--------	------------------	------	--





push 



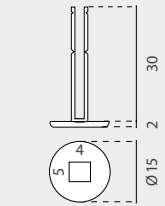

50.110	Ø 14.4 Ø 4.9mm	14.8mm	x100 
--------	------------------	--------	--







push 

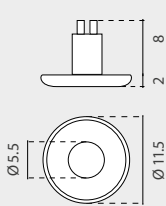



12.532	Ø 15 6x5mm	30/12mm	x100 
--------	--------------	---------	--





push 



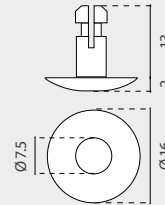

12.533	Ø 11.5 Ø 5.5mm	10mm	x100 
--------	------------------	------	--





push 



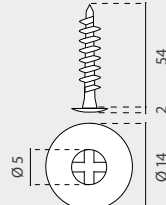

12.534	Ø 16 Ø 7.5mm	15mm	x100 
--------	----------------	------	--





screw 



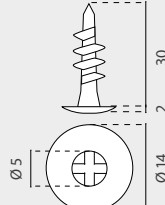

12.535	Ø 14 Ø 5mm	56mm	x100 
--------	--------------	------	--





screw 

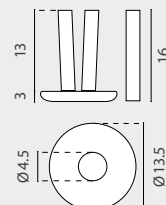

12.536	Ø 14 Ø 5mm	32mm	x100 
--------	--------------	------	--

push 



12.537	Ø 13.5 Ø 4.5mm	16mm	x100 
--------	------------------	------	--

CURVED STOPPER CLIP HOLDER



DIMENSIONS *mm

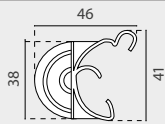

INFORMATION

This Curved Clip is ideal for attaching cards and being used as a promotion Stopper on shelving.

CURVED	SIZE	
12.474	41x46mm	x100 

STRAIGHT STOPPER CLIP HOLDER



DIMENSIONS *mm

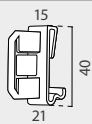

INFORMATION

This Straight Clip is ideal for attaching cards and being used as a promotion Stopper on shelving.

STRAIGHT	SIZE	
12.071	40x15mm	x100 

CLIP 39mm DATA STRIP



DIMENSIONS *mm

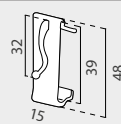

INFORMATION

This Data Strip Clip with hook is ideal for being used on 39mm shelf profiles at point of sale.

CLIP 39	SIZE	
12.451	15x48mm	x100 

SHELF LABEL HOLDER



INFORMATION

This Curved Clip features a hinged base for protecting signage against the shocks.



SHELF LABEL	SIZE	
12.414	78x152mm	x50 
12.417	78x203mm	x50 
12.419	106x152mm	x50 
12.421	106x203mm	x50 

HANGING LABEL HOLDER



INFORMATION

This white Label Holder features a 120x39mm card insert and 2 top plastic hook hangers. This label is ideal for promotion or as pricing holder for rods or wire baskets.

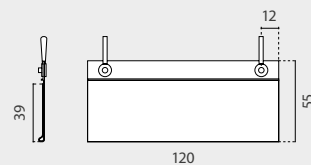

HANG LABEL	GRAPHIC SIZE	
12.295	120x39mm	x50 

SHELF STRIP LABEL HOLDER

HOLDER DETAILS

DIMENSIONS *mm

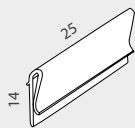

INFORMATION

This holder can be used on most of the standard shelf profiles and it allows 1mm max. graphic thickness.

SHELF STRIP	SIZE	
12.458	14x25mm	x100 

STOPPER SLEEVE HOLDER



INFORMATION

This transparent Sleeve Holder is ideal for being used as a stopper support.

SLEEVE	SIZE	
12.527	215x112mm	x20 



SHELF SIGNAGE Shelf Signage Holder

ADHESIVE COUPON LABEL HOLDER



INFORMATION

This coupon holder has a resistant back adhesive strip. 2 thicknesses available, 8mm for 75 coupons (115g paper) or 18mm for 125 coupons (115g paper). Ideal for promoting at supermarkets shelves.

ADHESIVE	THICKNESS		
12.212	8mm	x20	
12.214	18mm	x20	

GRIPPER COUPON LABEL HOLDER



INFORMATION

This coupon holder features a 75mm back gripper for attaching to the front of the shelves. 2 thickness: 8mm for 75 coupons (115g paper) or 18mm for 125 coupons (115g paper). Ideal for promoting at markets shelves.

GRIPPER	THICKNESS		
12.213	8mm	x20	
12.215	18mm	x20	

FRONT CLIP LABEL HOLDER



INFORMATION

This white snail clip is ideal for the communication on shelves, it has several applications thanks to its flexible long clip and its front adhesive. Ideal to compose long displays using more than one clip.

FRONT CLIP	SIZE		
12.232	30x70mm	x20	

STOPPER BANNER



INFORMATION

This transparent stopper for shelves has a straight holed 85mm arm holder with 4 spurs for attaching the graphics. Ideal for supermarkets shelves. Clip for attaching to shelf is not included.

STOPPER	HEIGHT		
12.222	85mm	x50	

3 POSITIONS STOPPER BANNER



INFORMATION

This transparent stopper for shelves has a 3 position arm holder with 6 spurs for attaching the graphics. Ideal for supermarkets shelves. Clip for attaching to shelf is not included.

3 POSITIONS	LENGTH		
12.223	145mm	x50	

CLIP BANNER CONNECTOR

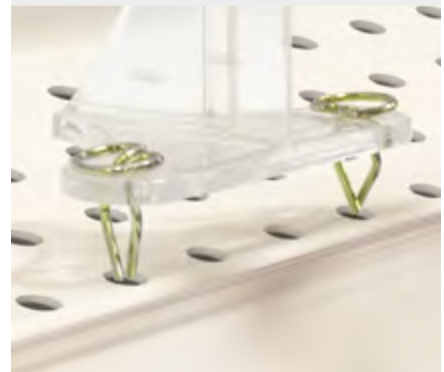

INFORMATION

This clip connector is suitable for being used with Stopper Banner (12.222) and 3 Position Stopper Banner (12.223) in 54mm spaced holes perforated shelves. It connects the stopper to the shelf.

CLIP	LENGTH		
12.224	18mm	x100	

TRANSPARENT WOBBLER



INFORMATION

*mm

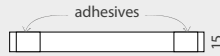

This transparent wobbler has 2 adhesive foampads. Swinging effect for making points of sale promotions.



TRANSPARENT	LENGTH		
12.203	150mm	x200 	
12.225	200mm	x200 	

ALUMINIUM WOBBLER



INFORMATION

*mm

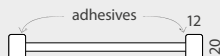

It is made of aluminium, with 2 adhesive foampads. Ideal for highlight any kind of messages from the shelf.



ALUMINIUM	LENGTH		
12.204	75mm	x100 	
12.205	150mm	x100 	

"ROUND" ALUMINIUM WOBBLER

INFORMATION

*mm



This aluminium wobbler has 2 adhesive rounded foampads. Perfect for highlight any kind of messages from the shelf.



ROUND	LENGTH		
12.294	89mm	x100 	

SPRING WOBBLER

INFORMATION

*mm



This wobbler has 2 square adhesive foam pads and a spring in the middle for giving movement to signage. Ideal for highlight messages with swinging effect.

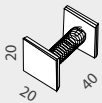

SPRING	SIZE		
12.206	20x20x40mm	x100 	

SPACER WOBBLER

INFORMATION

*mm



The spacer wobbler adds an extra spacing effect. Also, it has 2 adhesive foampads. Excellent to enhance points of sale and fitting into any kind of support.



SPACER	SIZE		
12.207	13x26x17mm	x100 	

WOBBLERS



MAGNETIC CORNER BASE



BASE DETAILS





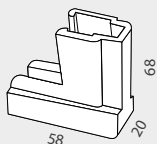

INFORMATION

*mm

This system of magnetic profile for shelves is composed by a corner base (2 colors available) and a not included guide or gripper (available) where the graphics or promotion cards are inserted. This versatile system is ideal to create promotions on shelves at supermarkets.



CORNER BASE	COLOR	WIDTH		
12.220		58mm	x20	
12.221		58mm	x20	



GRIPPER PROFILE FOR MAGNETIC CORNER BASE

PROFILE DETAILS



INFORMATION

This Profile is suitable for use with the Magnetic Corner Bases (12.220 - 12.221).



GUIDE PROFILE	LENGTH	MAX.GRAPHIC THICK		
12.218	300mm	5mm	x20	
12.219	460mm	5mm	x20	

PROFILE DETAILS



INFORMATION

This Profile is suitable for use with the Magnetic Corner Base (12.220 - 12.221).

GRIPPER PROFILE	LENGTH	MAX.GRAPHIC THICK		
12.216	300mm	3mm	x20	
12.217	460mm	3mm	x20	

MAGNETIC CLIP



CLIP DETAIL



INFORMATION

*mm

This magnetic base has a hinged clip which allows a max. graphic thickness of 8mm.

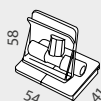

MAGNETIC CLIP	SIZE		
12.078	54x58x41mm	x50	

ADHESIVE CLIP



CLIP DETAIL



INFORMATION

*mm

This adhesive base has a gripper clip which allows a maximum graphic thickness of 0.5mm.

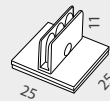

ADHESIVE CLIP	SIZE		
12.134	25x25mm	x100	

HOLDER DETAILS



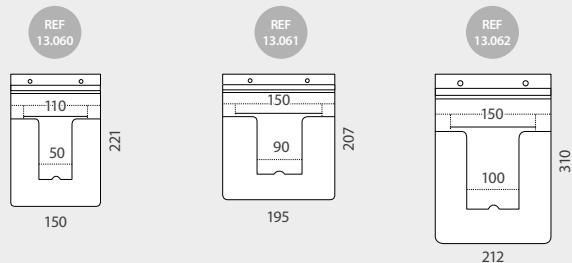

DIMENSIONS

*mm



INFORMATION

This dispensers are made of 0.5mm thickness PVC. Suitable for A5 or A6 documents (from 110 to 150mm maximum width documents). They are excellent for fixing on shelf edges thank to its top adhesive strip.

DISPENSER	DOCUMENT	SIZE	THICKNESS		
13.060	A6	150x221mm	0.5mm	x30	
13.061	A5-A6	195x207mm	0.5mm	x30	
13.062	A5	212x310mm	0.5mm	x30	

BROCHURE PVC HOLDER

PVC



HOLDER DETAILS

INFORMATION

*mm



This dispenser, made of PVC with adhesive strip, is excellent for holding business cards or promotional coupons. Container external size: 110x60x30mm.

DISPENSER	SIZE	THICKNESS		
13.431	110x60x30mm	0.4mm	x30	

COUPON CARD PVC HOLDER

PVC



STAND DETAILS

*mm

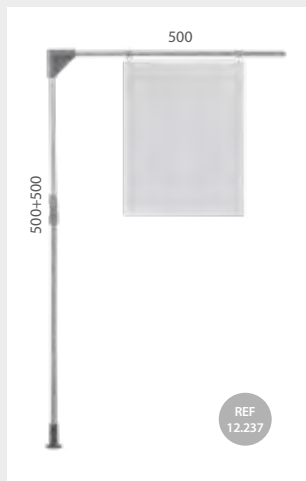
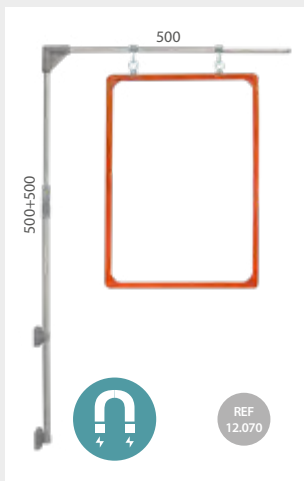



INFORMATION

It Includes a Telescopic pole + 500mm Upper Arm + 2 Magnetic holders. Frame kit not included. Suitable with any metallic furniture. Ideal for displaying at markets.

INFORMATION

It includes a Telescopic (500+500) pole + 500mm Upper Arm + Screw-in support base. Graphic holder not included. Ideal for being placed close to products at supermarkets.

L STAND	LENGTH	*mm	
12.070	Pole: 500+500 Upper Arm: 500	x20	
L STAND	LENGTH	*mm	
12.237	Pole: 500+500 Upper Arm: 500	x20	

EXTENDABLE "L" STAND

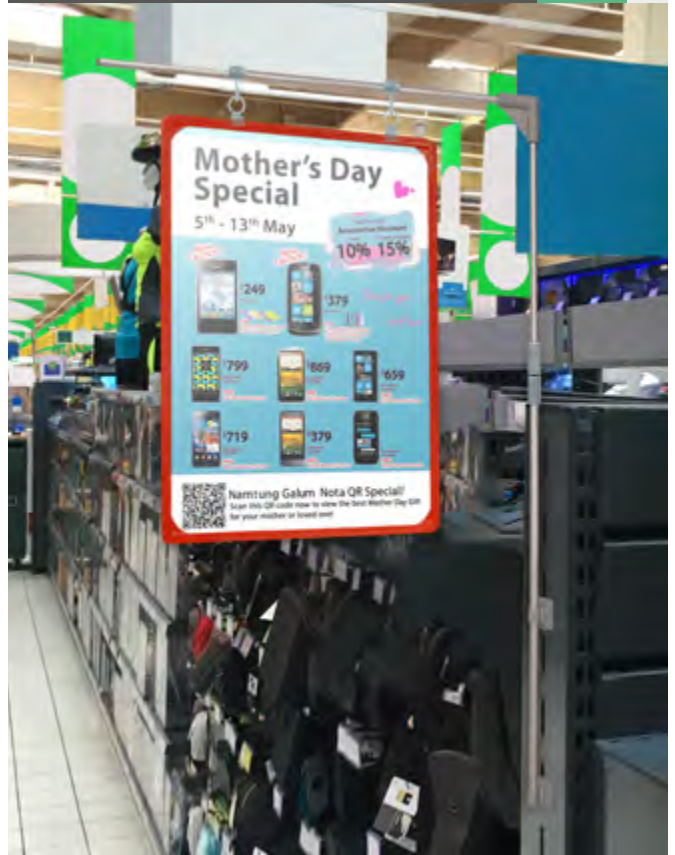

STAND DETAILS

*mm

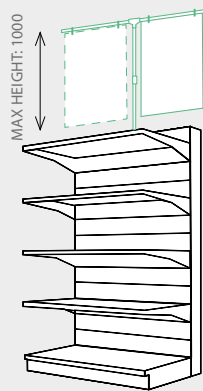
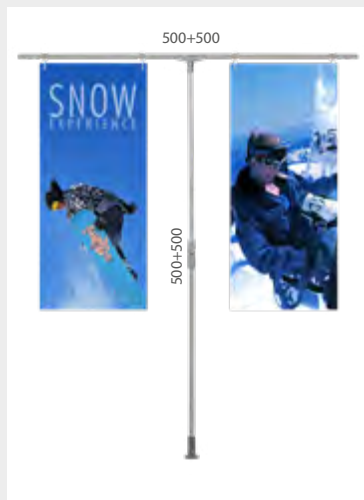

Ideal for being placed up supermarket gondolas.

INFORMATION

"T" Stands includes a Telescopic Pole (1000mm max. height) + Screw-in support + "T" Clamp + Upper Arms + Hooks. Ideal for displaying sales at supermarkets.

EXT. STAND	LENGTH	*mm	
12.075	Pole: 500+500 Upper Arms: 500+500	x20	

EXTENDABLE "T" STAND

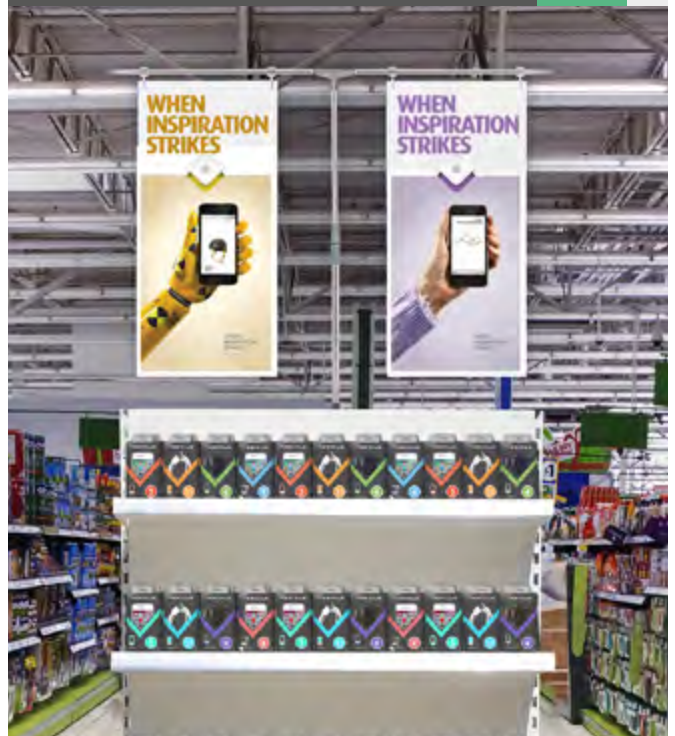

SHELF SIGNAGE Shelf Extendable Banners

Various graphic displays for gondola or shelf-systems.

They are ideal to for holding signage at point of sales

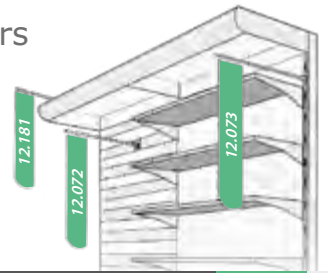

INFORMATION

Telescopic tube (600mm max.) for Slatwalls. With 2 plastic hooks for holding signage.

SLATWALL	LENGTH	
12.072	Tube: 300+300mm	x10 

EXTENDABLE BANNER FOR SLATWALL



INFORMATION

Telescopic tube (600mm max.) for Pegboard. With 2 plastic hooks for holding signage.



UPRIGHT	LENGTH	
12.073	Tube: 300+300mm	x10 

EXTENDABLE BANNER FOR PEGBOARD



INFORMATION

Telescopic tube with 2 plastic hooks and 2 magnetic bases for metallic surfaces. This support for shelving features 3 lengths available (600, 800 or 1000mm).

MAGNET	LENGTH	
12.181	Tube: 300+300mm	x10 
12.231	Tube: 400+400mm	x10 
12.300	Tube: 500+500mm	x10 

MAGNET EXTENDABLE BANNER



HOOK DETAIL

INFORMATION

*mm



This transparent plastic hook is perfect for using with Extendable "L" or "T" Stands or Extendable Banners. Ideal for being used at supermarkets

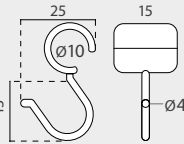

POLE HOOK

12.076	x20 
--------	---

POLE HOOK



SHELF SIGNAGE Shelf Magnet Banners

Magnetic holder system suitable for metallic shelves.



INFORMATION

This magnetic shelf holder system features multiple solutions to the implementation of graphic promotions to metal shelves. The base is made of ABS with a magnet inside, it sizes 40x70mm, also it can be rotated to adjust exposure to optimal angle. To adjust the pole angle to the desired exposure, simply detach the base slightly from the angle bracket **2**, adjust the pipe to the proper angle **3**, and return the base to its original position so that it is secure **4**. The aluminum pole offers the possibility of approaching the promotion to the passerby and has several options to hang different sizes of graphics, including transparent movable hooks, transparent movable clips or grippers for attaching posters or promotions. Either to be used on or below the shelf, several models are available to meet your needs. This multi-position holder system is often used on metallic shelves, poles or walls, so it is widely used in shopping malls specially in shopping center, supermarket aisles or pharmacies.

POLE ANGLE ADJUSTMENT



SHELF SIGNAGE Shelf Magnet Banners

HOLDER DETAILS



INFORMATION

*mm

This multi-position promotion holder features 1 transparent gripper for attaching graphics and a curved pole which is ideal for being used on walls, poles or onto-beneath the shelves.

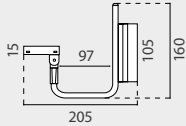

GRIPPER

12.511

x2 

GRIPPER MAGNET BANNER



HOLDER DETAILS



INFORMATION

*mm

This multi-position holder system features 2 transparent clamps and an angled pole which is ideal to get an extra separation from the product.

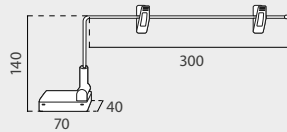

ANGLED

12.302

x10 

ANGLED MAGNET BANNER

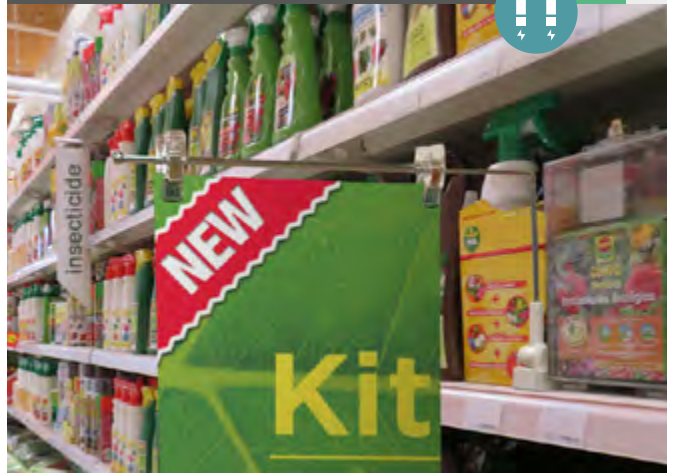

HOLDER DETAILS



INFORMATION

*mm

This multi-position holder features 2 transparent clamps and a straight pole which is ideal for occupying as little space as possible on the shelf.

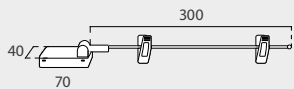

STRAIGHT

12.303

x10 

STRAIGHT MAGNET BANNER

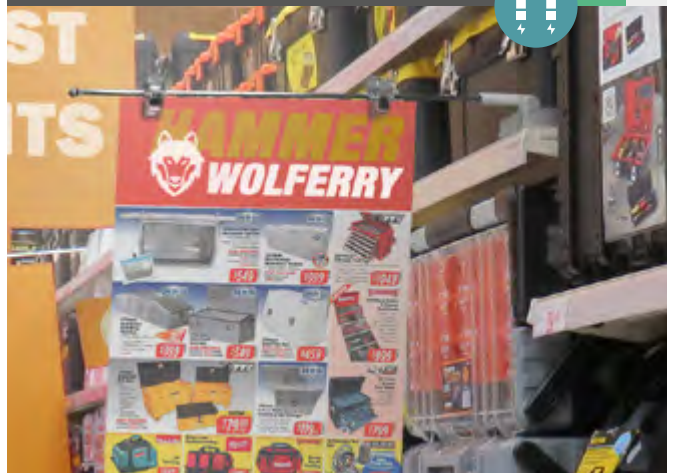

SHELF SIGNAGE Shelf Magnet Banners

HOLDER DETAILS



INFORMATION

*mm

This multi-position holder features 2 transparent hooks and a curved 400mm pole which is ideal for being used onto or beneath the shelves.

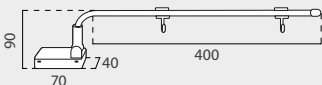

400 HOOK

12.381

x10 

CURVED 400 MAGNET BANNER

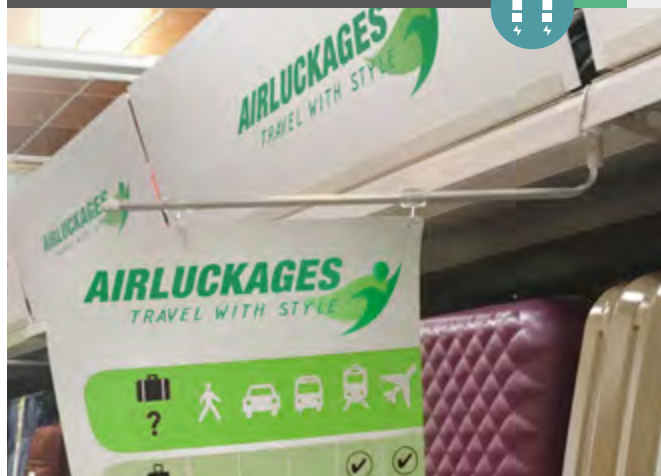

HOLDER DETAILS



INFORMATION

*mm

This multi-position holder features 2 transparent hooks and a 300mm curved pole which is ideal for being used onto or beneath the shelves.

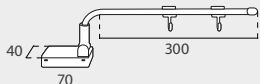

300 HOOK

12.555

x10 

CURVED 300 MAGNET BANNER

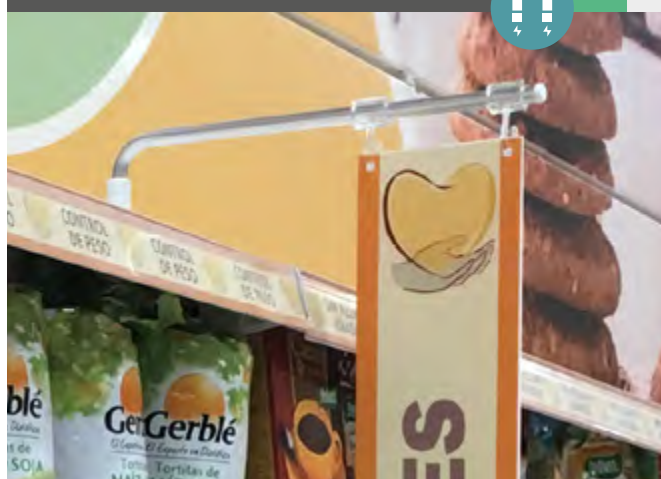

HOLDER DETAILS



INFORMATION

*mm

This multi-position holder features 2 transparent hooks and a 200mm curved pole which is ideal for being used onto or beneath the shelves.

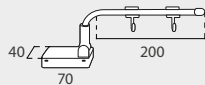

200 HOOK

12.557

x10 

CURVED 200 MAGNET BANNER



MINI FLAG 300 POLE

POLE DETAILS



REF
12.174



REF
12.175



REF
12.176



INFORMATION

300mm white flag pole with adhesive removable base. Available on 3 angles for displaying.

MINI FLAG	ANGLE	LENGTH		
12.174	60°	300mm	x50	
12.175	90° wall	300mm	x50	
12.176	180° shelf	300mm	x50	

MINI FLAG 300 POLE WITH RING CLIPS

POLE DETAILS

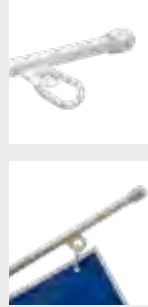

REF
12.177



REF
12.178



REF
12.179



INFORMATION

300mm flag pole with adhesive removable base and clips for hanging graphics. 3 angles.

MINI RING FLAG	ANGLE	LENGTH		
12.177	60°	300mm	x50	
12.178	90° wall	300mm	x50	
12.179	180° shelf	300mm	x50	

60° FLAG POLE



INFORMATION

60° flag pole with adhesive 115x50mm base. Flag can be inserted into the slot **1**. 3 lengths.

60° FLAG POLE	ANGLE	POLE DIAMETER	LENGTH		
12.297	60°	∅ 18mm	280mm	x20	
12.299	60°	∅ 18mm	400mm	x20	
12.289	60°	∅ 18mm	600mm	x20	

90° FLAG POLE



INFORMATION

90° flag pole with adhesive 115x50mm base. Flag can be inserted into the slot **1**. 3 lengths.

90° FLAG POLE	ANGLE	POLE DIAMETER	LENGTH		
12.298	90°	∅ 18mm	280mm	x20	
12.288	90°	∅ 18mm	400mm	x20	
12.290	90°	∅ 18mm	600mm	x20	

300 FLAG BANNER MAGNET SUPPORT

SUPPORT DETAIL



INFORMATION

300mm flag pole with reinforced magnetic base. Ideal for shelving at supermarkets.

MAG. BANNER	LENGTH		
12.173	300mm	x10	

300 FLAG BANNER ADHESIVE SUPPORT

SUPPORT DETAIL



INFORMATION

300mm flag pole with double adhesive pads base. Ideal for shelving at supermarkets.

ADH. BANNER	LENGTH		
12.180	300mm	x20	

SUPPORT DETAILS



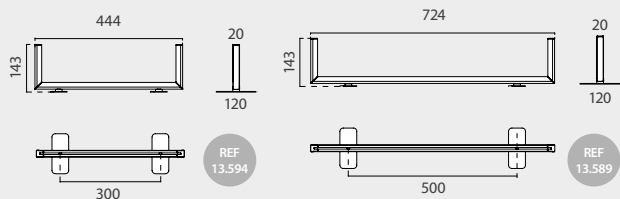

DIMENSIONS

* mm



INFORMATION

This open white painted aluminium frame support features an easy glide for the graphic poster (5mm max. thickness). Also, it features 2 magnetic supports at the bases. Ideal for promoting on shelves at malls or at the supermarkets.

OPEN M.S.444	QTY	N.W	G.W	C.B.M	SIZE
Packing	2	0.94kg	1.08kg	0.0026	480x180x30mm
13.594	Graphic Width: 420mm		x2 		
OPEN M.S.724	QTY	N.W	G.W	C.B.M	SIZE
Packing	2	1.12kg	1.27kg	0.0041	760x180x30mm
13.589	Graphic Width: 700mm		x2 		

OPEN ALUMINIUM MAGNET SUPPORT



DISPLAY DETAILS



DIMENSIONS

* mm

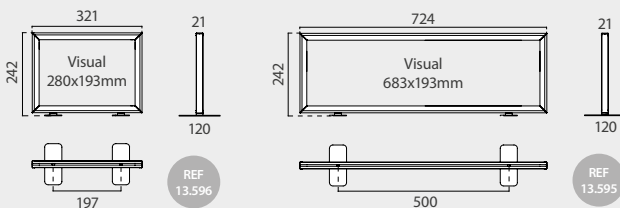

INFORMATION

This closed silver aluminium frame support features an easy glide for the graphic poster (5mm max. thickness). Also, it features 2 magnetic supports at the bases. Ideal for promoting on shelves at malls or at the supermarkets.

CLOSED M.S.321	QTY	N.W	G.W	C.B.M	SIZE
Packing	2	1.5kg	1.61kg	0.0046	335x250x55mm
13.596	Graphic Size: 298x220x5mm		x2 		
CLOSED M.S.724	QTY	N.W	G.W	C.B.M	SIZE
Packing	1	0.88kg	1kg	0.0055	735x250x30mm
13.595	Graphic Size: 700x220x5mm		x2 		

CLOSED ALUMINIUM MAGNET SUPPORT



SHELF SIGNAGE Clip Strip

STRIPS DETAILS



DIMENSIONS *mm



STRIP 780	HEIGHT	THICK	
12.525	780mm	2mm	x50 



STRIPS DETAILS



DIMENSIONS *mm



STRIP 663mm	HEIGHT	THICK	
12.228	663mm	0.8mm	x50 

CLIP STRIP



STRIPS DETAILS



DIMENSIONS *mm



STRIP 620	HEIGHT	THICK	
12.526	620mm	1.13mm	x50 



STRIPS DETAILS



DIMENSIONS *mm

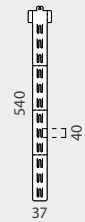

STRIP 540mm	HEIGHT	THICK	
12.229	540mm	0.5mm	x50 



HOOK DETAILS



INFORMATION *mm

This 38 length double hook is made of metal and it is ideal for being used with the plastic clip strips thanks its bottom hook design wich prevents the merchandising strip from falling.



STRIP HOOK	LENGTH	
12.157	38mm	x100 

STRIPS DETAILS



DIMENSIONS *mm



STRIP 530mm	HEIGHT	THICK	
12.227	530mm	0.5mm	x50 





Coating

13

A wide range of coating accessories which provide an integral solution for professional of printing presses, sign making business or design studios.

- 566** SQUEEGEES
- 568** CUTTING ACCESSORIES
- 570** MEASUREMENT
- 573** SIGNMAKING ACCESSORIES
- 576** FASTENING | TRANSPORT
- 578** MAGNET SERIES
- 580** EYELET MACHINE
- 581** BADGE MACHINE
- 582** HEAT GUNS



SQUEEGEES



*mm

This rectangular squeegee is made of 100% wool. Thanks to its dimension is ideal for the application of vinyl.



16.012 100x70x13mm x10



*mm

This "half moon" squeegee is made of 100% wool. Thanks to its shape is ideal for the application of vinyl.

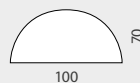

16.014 100x70x13mm x10



*mm

This squeegee has been designed for an ergonomic use. Blue colored. It is ideal for the application of vinyl.

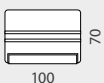

16.096 100x70mm x10



*mm

This white squeegee has been designed for an ergonomic use and the application of vinyl.



16.003 100x70mm x10

16.004 130x70mm x10

PLASTIC-RUBBER SQUEEGEE



*mm

This squeegee features a plastic blue colored handle and a white "V" shaped with land rubber profile with flat tip. It is ideal for the application of vinyl.

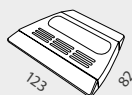

16.097 123x82x30mm x10

WOOD-RUBBER SQUEEGEE



*mm

This squeegee features a wood handle. "V" shaped and blue colored rubber profile with sharp tip. It is ideal for the application of vinyl.

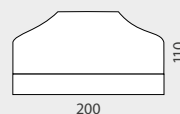

16.099 200x110x44mm x5

SQUEEGEES Squeegees

XL SQUEEGEE



*mm

This squeegee is made of yellow colored plastic. Thanks to its size is ideal for several applications, such as car styling decal, vinyl film, stickers, covers scrape...

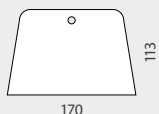

16.098 170x113mm x10

XXL SQUEEGEE



*mm

This big squeegee is made of blue colored plastic. Thanks to its ergonomic plastic handle is ideal for the application of car styling decals, vinyl films, stickers or covers scrape.

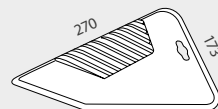

16.101 270x173mm x5

240mm SQUEEGEE ERGONOMIC PAD



*mm

This squeegee is made of plastic. Thanks to its ergonomic plastic pad is ideal for the application of car styling decals, vinyl films, stickers or covers scrape.



16.000 108x240mm x10

135mm SQUEEGEE ERGONOMIC PAD



*mm

This squeegee is made of plastic. Thanks to its ergonomic plastic pad is ideal for the application of car styling decals, vinyl films, stickers or covers scrape.



16.001 60x135mm x10

115mm SQUEEGEE PAD



*mm

This squeegee is made of plastic. Thanks to its dimensions and to its pad is ideal for the application of vinyl in small places.



16.002 90x115mm x10

PRECISION SQUEEGEE



*mm

This squeegee is made of plastic. Thanks to its reduced size is ideal for the application of vinyl in small places

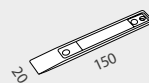

16.006 20x150mm x10

CUTTING ACCESSORIES Cutting Accessories

PRECISION 9mm CUTTER



*mm

This slimline metallic cutter is ideal for cutting vinyl, tint or paper... Its 9mm steel blade features an optimum sharpness for an improved precision.

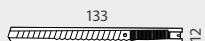

16.063

x5

STANDARD 9mm CUTTER



*mm

This popular cutter has a 9mm high carbon tool steel blade for an optimum sharpness. Blade snapper and clip for pockets are included.

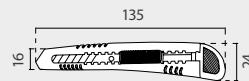

16.140

x20

PRO TOUCH 9mm CUTTER



non slip design

*mm

This Pro-Touch cutter has a 9mm high carbon tool steel blade and features an ergonomic rubber handle. Blade snapper is included.

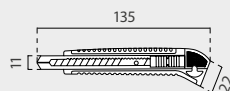

16.143

x5

HEAVY-DUTY 18mm LARGE CUTTER



non slip design

*mm

This cutter has a 18mm high carbon tool steel blade and features an ergonomic rubber handle. With a hole for lanyards.

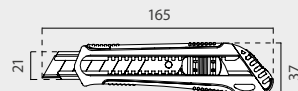

16.142

x5

RETRACTABLE 18mm PROFESSIONAL CUTTER



autoretractable blade, holding down the button

*mm

Professional cutter has a 18mm high carbon tool steel autoretractable blade and also, it features autolock system. With an ergonomic rubber handle and hole for the lanyards.

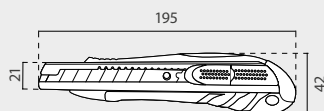

16.141

x5



non slip design

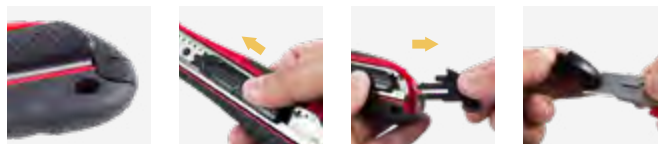

MINI SMALL CUTTER



*mm

This small cutter is ideal for trimming vinyl, tint or paper. Its special design is ideal for an improved precision with long continuous cuts.

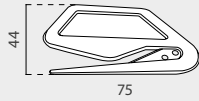

16.103 75x44x3mm x20

SNAPPY SAFE CUTTER



The Snappy Cutter features a blade adjustment with safety lock system. Its special design is ideal for an improved precision with curved cuts.



16.007 x10



adjustable blade

*mm

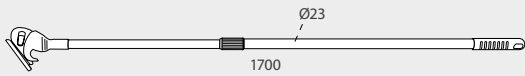

The Telescopic Cutter features a blade adjustment with safety lock system. Its adjustable length tube is ideal for an improved precision in height cuts.

16.104 Ø23x1700mm

TELESCOPIC CUTTER



CUTTING MAT



This mat is ideal for precision cutting. It features 5 dimensions available.

16.061 A5

16.062 A4

16.066 A3



16.067 A2

16.068 A1



MAGNETIC RULER



This Magnetic Measuring Ruler provides a convenient solution for determining approximate distances without using the hands on an optical table or breadboard. With a magnetic back that extends throughout the meter area, this measuring tape lays flat on any magnetic surface and features both imperial and metric scales.

16.122

Length: 1000mm/36"



MAGNETIC RULER



This Magnetic Ruler provides a convenient solution for determining approximate distances without using the hands. With a magnetic back that extends throughout the meter area, this measuring tape lays flat on any magnetic surface.

16.123

Length: 1000mm



This rule provides a safe and convenient solution for precision cutting work. Featuring 3 lengths of Safety Cutting Ruler (1000mm, 1500mm and 2500mm).

SAFETY CUTTING RULER



16.030

Length: 1000mm

16.031

Length: 1500mm

16.032

Length: 2500mm

MEASUREMENT Measure Tapes



stop locking system



ABS 5m 25mm TAPE MEASURE



5m tape
25mm blade

This ultra durable ABS pocket tape measure features a 5m tape with a 25mm wide blade. Featuring a strong blade locking system, belt clip and wrist strap.

16.144 Length: 5000mm Width Blade: 25mm x5



suitable for
metallic surfaces

MAGNETIC 5m 25mm TAPE MEASURE



stop locking system



magnetic extreme

This Professional ultra durable tape measure is highly resistant thanks to its anti-shock ABS plastic case and comfortable thanks to its soft grip rubber outer. It features a 5m tape with a 25mm wide blade. Featuring a magnetic end hook, which connects securely to metals (shelves, beading, pipework, etc) but can be easily removed from the surface. Also it has One-Stop lock system, belt clip and wrist nylon strap.

16.146 Length: 5000mm Width Blade: 25mm x5



This ultra durable ABS tape measure features a 30m or 50m tape. A folding handle with rotating knob makes an easy rewinding. With wrist nylon strap

16.070 Length: 30000mm x5

16.071 Length: 50000mm x5

MEASURING TAPE



HAND CALIPER



Calipers can be used to measure internal and external dimensions with utmost precision.

16.058 From 0 to 150mm

DIGITAL CALIPER



Digital measure (mm to inches). Zero button which sets any reference point to zero.

16.057 From 0 to 150mm

Battery-operated digital High Precision Pocket Scales. With easy-to-read LCD.



16.055 Weight capacity: 0.1 - 500g

HIGH PRECISION POCKET SCALE



16.056 Weight capacity: 0.01 - 300g

LINEN TESTER 33.3mm



This line tester frame folds flat for an easy storage. Featuring 33mm height.

16.077 44x30x33.3mm

LINEN TESTER 50mm



This line tester frame folds flat for an easy storage. Featuring 50mm height.

16.078 55x40x50mm

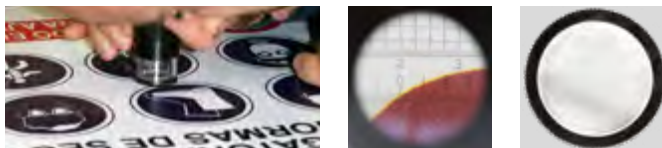

This High Quality Line Tester is preferred for professional usage. Transport pocket included. It is, also used for an extensive range of professions: graphic design, desktop publishing, film/dia/photo negatives and even in biology...

16.079 \varnothing 25x53mm

LINEN TESTER LUXE

transport pocket included



WALL ROLL STORAGE

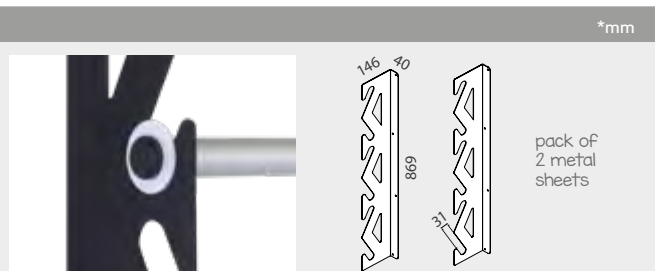

This black colored metallic holders allows you to store vinyl or rolls of clothes. It is sold in packs of 2 units. Easy and fast mounting to the wall. It is ideal for being used at printing presses, sign makers, design studios or for tailor stores.

ROLL STORAGE	QTY	N.W	G.W	C.B.M	SIZE
Packing	1	3.97kg	4.26kg	0.0075	170x890x50mm
13.849		146x869x40mm		x2	



* roll tube not included

MOVABLE ROLL STORAGE

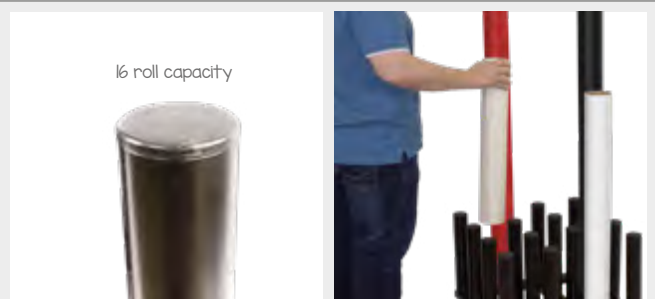

16 roll capacity

This metallic 500x500x400 mobile unit allows you to store 16 vinyl rolls. Allen key and 4 rotary brake wheels are included. Ideal for printing presses, sign makers, design studios or for tailor shops.

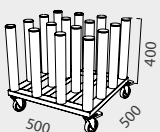

*mm

16.115	500x500x495	16 rolls capacity
--------	-------------	-------------------



brake wheels

* vinyl rolls not included

SPEED CLIP SMALL



Clip fastener for vinyl or rolls of clothes. It is made of purple colored plastic. Ø83mm or Ø110mm available. Ideal for printing presses, sign makers, design studios or for tailor shops.

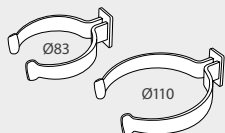

*mm

16.108	Ø83mm	x20
16.109	Ø110mm	x20



TOOL BAG L



Ideal for
tool belts



This black and red tool bag is made of nylon. It is ideal for being used with a tool belt. Featuring several tool pockets and various applications.

16.105

280x175mm

TOOL BAG XL



This black and grey tool bag is made of nylon. It is ideal for being used as a tool belt. Featuring several tool pockets and various applications.

16.106

295x260mm

MAGNETIC WRIST HOLDER



Magnetic wrist holder with genuine VELCRO® brand system. Ideal for attaching tools.

16.126

CLEANING SWAB



These Cleaning swabs are ideal for labelling to fix small imperfections.

16.008

x10

MAGNETIC RING



*mm

This single magnetic Ø30mm ring with folding handle is ideal for holding vinyls while labelling.



16.124

Ø30mm

MAGNETIC BASE

suitable for any metallic surface



*mm

This single Ø60mm magnetic ring thanks to its big diameter is ideal for holding vinyls while labelling.

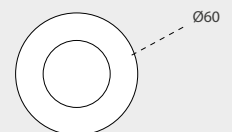

16.125

Ø60mm

ELASTIC CORD

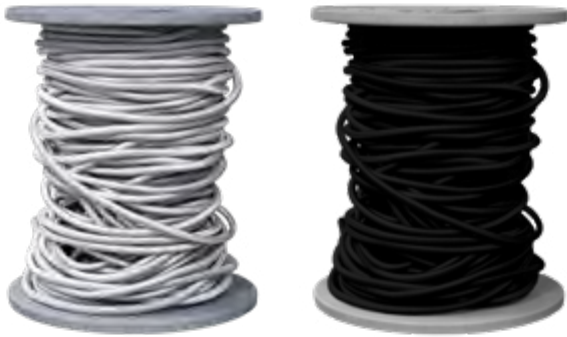

16.039		Ø6mm	
16.040		Ø6mm	

CORNER GRIPS



easy clip-on

*mm

- Made of nylon.
- It allows to hang the banner with corners, keeping it perfectly in tension.

16.110	x40		
--------	-----	--	--

FISHING NYLON ROLL

roll length: 500m



16.038	Ø0.5mm	Roll length: 500m	
--------	--------	-------------------	--

NYLON LINE

roll length: 5m



12.373	Ø0.5mm	Roll length: 5m	x100	
--------	--------	-----------------	------	--

velcro



Reusable genuine VELCRO® brand fasteners strap. Ideal for tying, holding or securing.

16.111	20x200mm	x50	
16.112	20x300mm	x50	
16.113	20x400mm	x50	

ADJUSTABLE FIXING STRAP



* VELCRO® is a registered trademark of Velcro BVBA. | VELCRO® est une marque déposée de Velcro Industries B.V. | VELCRO® é uma marca registrada de Velcro Industries B. V. | VELCRO® es una marca registrada de VelcroIndustries B. V.

CABLE TIES



These Cable Ties are ideal for being used as fastener for several uses, such as for primarily electrical cables, holding items together or wires. Black or transparent finish. 12 sizes available of cable ties.

16.043
16.044

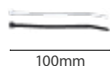

100mm

16.045
16.046



150mm

16.047
16.048



200mm

16.049
16.050



250mm

16.051
16.052



300mm

16.053
16.054



400mm

16.043		2.5x100mm	x100
16.044		2.5x100mm	x100
16.045		3.6x150mm	x100
16.046		3.6x150mm	x100
16.047		4.8x200mm	x100
16.048		4.8x200mm	x100

16.049		4.8x250mm	x100
16.050		4.8x250mm	x100
16.051		4.8x300mm	x100
16.052		4.8x300mm	x100
16.053		7.2x400mm	x100
16.054		7.2x400mm	x100

SUCTION CUPS



This single suction cup with folding handles is ideal for the transport of heavy panels up to 30kg weight.



Double suction cup for the transport of heavy panels up to 60kg weight.

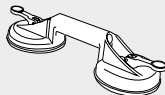

Double suction cup for the transport of heavy panels up to 120kg weight.



16.016	Capacity: 30kg
--------	----------------



16.017	Capacity: 60kg
--------	----------------

16.018	Capacity: 120kg
--------	-----------------



3 sizes available

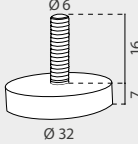
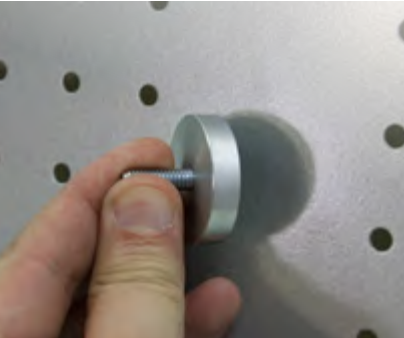

																				
16.080	Ø8x3mm	x50 	16.081	Ø10x3mm	x50 	16.082	Ø20x5mm	x10 												

NEODYMIUM MAGNETIC INSERT DISCS

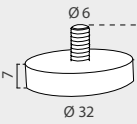
					
16.084	Base: Ø32x7mm Screw: Ø6x16mm	x10 			

FERRITE MAGNETIC BASE

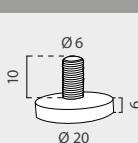
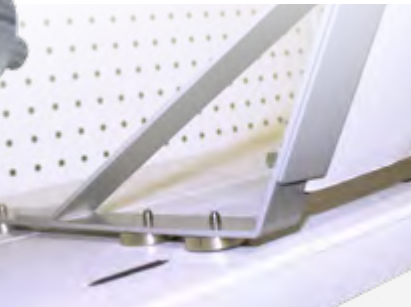

					
16.083	Base: Ø32x7mm Screw: Ø6x10mm	x10 			

					
16.085	Base: Ø20x6mm Screw: Ø6x10mm	x10 			



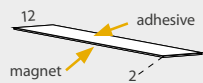

NEODYMIUM MAGNETIC BASE

					
16.086	Base: Ø32x7mm Screw: Ø6x10mm	x10 			

MAGNETIC STRIP ROLL

					
<p>- 50m Roll. - 2mm thickness strip. - One adhesive side for fixing to the graphics.</p>					
	QTY	N.W	G.W	C.B.M	SIZE
Packing	1	3.4kg	3.82kg	0.0038	390x25x390mm
10.360	50m roll				

MAGNETIC STRIP BY LINEAL METERS

					
16.087	Adhesive	Size: 20x1.2mm			
					
16.088	Magnetic	Size: 20x1.2mm			

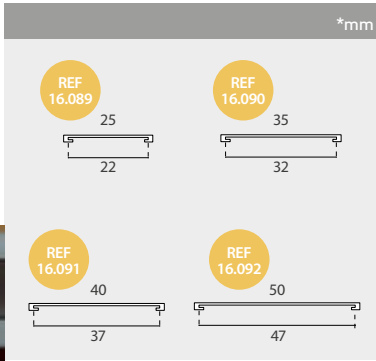

16.089	Label width: 22mm		
16.090	Label width: 32mm		

MAGNETIC DATA STRIP

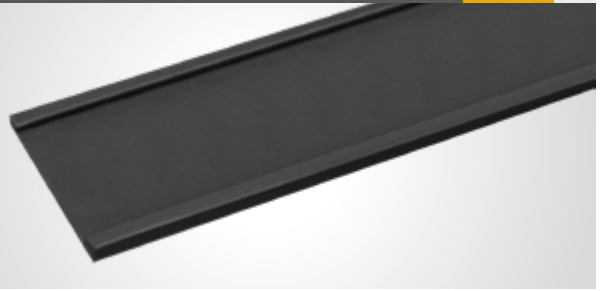

16.091	Label width: 37mm		
16.092	Label width: 47mm		

* Glasspack protector is not included



16.093	150x100x2mm		
16.094	950x400x2mm		

MAGNETIC SHEET ANISOTROPIC

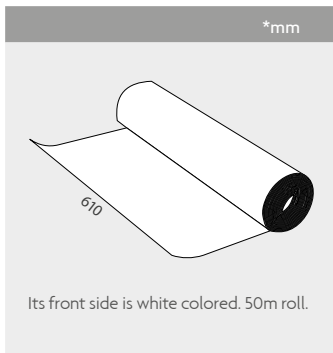
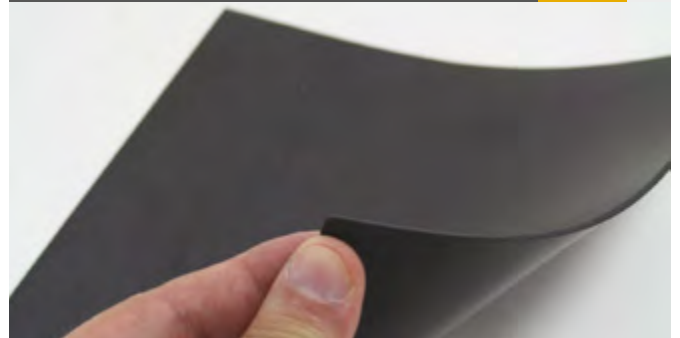

16.095	610x0.6mm	Roll length: 50m		
--------	-----------	------------------	--	--

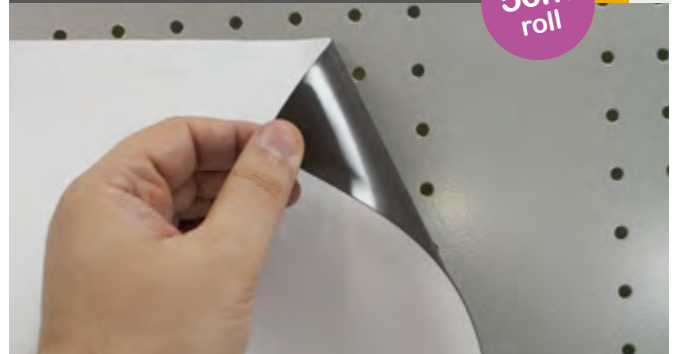

MAGNETIC ROLL ANISOTROPIC

50m roll

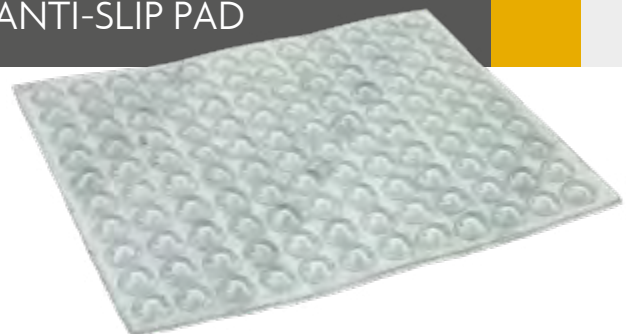

ANTI-SLIP PAD



16.100	Diameter: Ø10mm	x120 	
--------	-----------------	--	---

EYELET MACHINE Eyelet Machine

TABLE EYELET MACHINE

This heavyweight professional hand operated press Eyelet Machine is designed to insert eyelet adapters (grommet die) from diameter from Ø6mm to Ø12mm. Changing adapters is simple (it includes 1 Allen key). It is a valuable addition to any workroom. It features holes at the base for fixing to any appropriate work surface. It is a valuable addition to any workroom. Its solid construction will give years of service in the workshop or out with the fitters.

TABLE EYELET ADAPTERS



*mm

For Ø6



REF 16.121

For Ø8



REF 16.020

For Ø10



REF 16.120

For Ø12



REF 16.021



16.121

Header diameter: Ø6mm



16.020

Header diameter: Ø8mm



16.120

Header diameter: Ø10mm



16.021

Header diameter: Ø12mm



16.019

Header diameter: Ø10mm

EYELETS

for table eyelet adapter



16.026



Ø6mm

x1000

16.022



Ø6mm

x1000

16.027



Ø8mm

x1000

16.023



Ø8mm

x1000

16.028



Ø10mm

x1000

16.024



Ø10mm

x1000

16.029



Ø12mm

x1000

16.025



Ø12mm

x1000

BADGE MAKING MACHINE



includes mold



available in 3 diameters



16.131 Diameter: Ø25mm

16.132 Diameter: Ø37mm

16.133 Diameter: Ø58mm

METAL PIN BADGE



These Metal Badges include base with pin + cap + protection cover. 3 diameters.

16.134 Diameter: Ø25mm x100 📦

16.135 Diameter: Ø37mm x100 📦

16.136 Diameter: Ø58mm x100 📦

PLASTIC PIN BADGE



These Plastic Badges include base with pin + cap + protection cover. 3 diameters.

16.137 Diameter: Ø25mm x100 📦

16.138 Diameter: Ø37mm x100 📦

16.139 Diameter: Ø58mm x100 📦

ideal for bending and welding plastic, softening adhesive, etc

HEAT GUN



Voltage & Frequency:	230V - 50Hz
Rate power I/II:	1000/2000W
Temperature I/II:	350/550° C
Air Flow I/II:	300/500 l/min.
VDE plug:	2m cable

16.128



Voltage & Frequency:	230V - 50Hz
Rate power I/II:	2000W (Max)
Temperature I/II/III:	80/80-600/80-600° C
Air Flow I/II/III:	350/350/500 l/min.
VDE plug:	2m cable
Adjustable temperature	

16.129



Voltage & Frequency:	230V - 50Hz
Rate power I/II:	2000W (Max)
Temperature I/II/III:	50/70-600/70-600° C
Air Flow I/II/III:	300/300/500 l/min.
VDE plug:	2m cable
Display:	LCD
Adjustable temperature	

16.130





Shopfitting

14

Wide range of panels, shelving systems, prongs, equipment, fixtures, safety and parking accessories which provide an integral solution for stores at POS.

- 584** GRIDWALL
- 587** SLATWALL
- 594** PEGBOARD
- 598** BACK RAIL SYSTEM
- 602** PRONGS ACCESSORIES
- 606** SECURITY DISPLAY
- 610** LINE PROFILES
- 616** SHELF MANAGEMENT
- 623** STORE ACCESSORIES
- 640** PARKING | SAFETY SUPPLIES





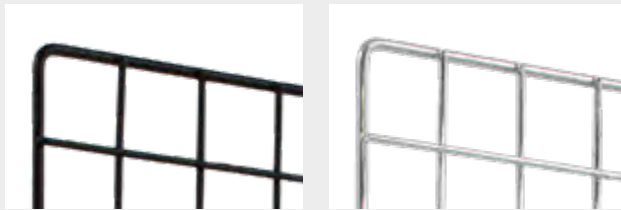
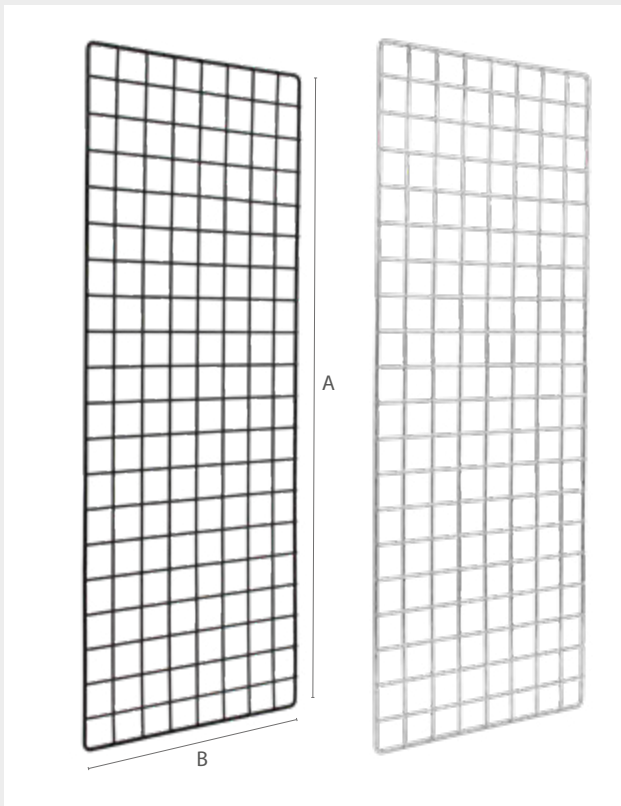





















PANEL DETAILS



INFORMATION

This Gridwall panel is extremely flexible system for displaying almost all type of products in any environment. Heavy duty metal construction, it is easy to install in horizontal or vertical orientation. It can be used with any standard sized hook accessories. Available in black and chrome finish.

GRIDWALL	COLOUR	SIZE (AxB)		
50.340	 Black	1000x400mm	x1 	
50.340	 Chromed	1000x400mm	x1 	17.50 €/unit
50.341	 Black	1000x600mm	x1 	
50.341	 Chromed	1000x600mm	x1 	
50.342	 Black	1000x800mm	x1 	
50.342	 Chromed	1000x800mm	x1 	
50.343	 Black	1000x1000mm	x1 	
50.343	 Chromed	1000x1000mm	x1 	
50.344	 Black	1500x400mm	x1 	
50.344	 Chromed	1500x400mm	x1 	
50.345	 Black	1500x600mm	x1 	
50.345	 Chromed	1500x600mm	x1 	

GRIDWALL PANELS

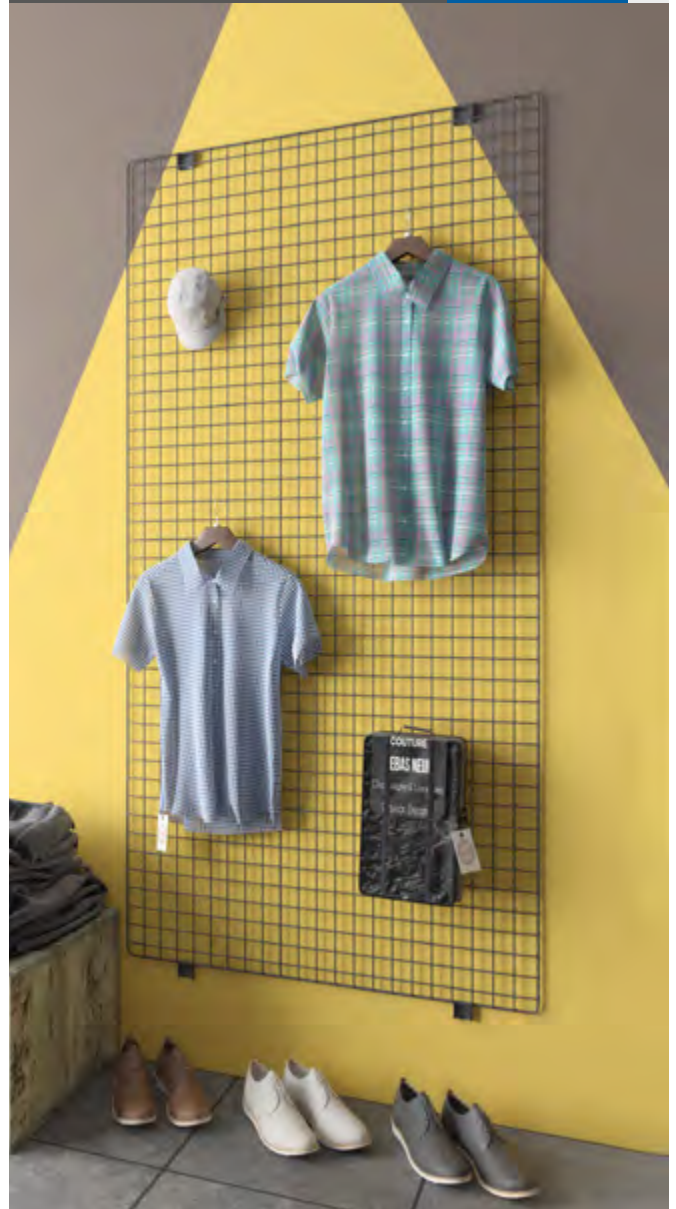

























GRIDWALL	COLOUR	SIZE (AxB)		
50.346	 Black	1500x800mm	x1 	
50.346	 Chromed	1500x800mm	x1 	
50.347	 Black	1500x1000mm	x1 	
50.347	 Chromed	1500x1000mm	x1 	
50.348	 Black	2000x400mm	x1 	
50.348	 Chromed	2000x400mm	x1 	
50.349	 Black	2000x600mm	x1 	
50.349	 Chromed	2000x600mm	x1 	
50.353	 Black	2000x800mm	x1 	
50.353	 Chromed	2000x800mm	x1 	
50.354	 Black	2000x1000mm	x1 	
50.354	 Chromed	2000x1000mm	x1 	

PLATE DETAILS INFORMATION *mm



This steel mounting plate is the easiest way to hang your grid mesh panels on the wall. Each panel requires at least 4 mounting plates. 2 colors available. Comes in 20 pieces pack. Screws are not included.





MOUNTING	COLOUR	SIZE	
50.261	 Black	40x40x15mm	x20 
50.261	 Grey	40x40x15mm	x20 



CLIP HOOK



HOOK DETAILS *mm





"C" HOOK	LENGTH	
12.157	38mm	x100 

"C" HOOK

HOOK DETAILS *mm





"C" HOOK	LENGTH	
12.155	80mm	x100 
12.156	39mm	x100 

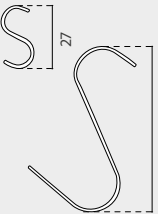

"S" HOOK

HOOK DETAILS *mm

"C" HOOK	LENGTH	Ø WIRE	
12.152	27mm	Ø1.1mm	x100 
12.154	120mm	Ø2mm	x100 

DISPLAY DETAILS

Wire steel dumpbin features a collapsible design which allows an easy setup, packing and storing. Frame spacing allows for lifts to be used during store resets. It is ideal for displaying last minute add-on items on the point of sale.

400 400



REF 50.350

400 600



REF 50.351

600 1000



REF 50.352

WIRE D1	QTY	N.W	G.W	C.B.M	SIZE
Packing	1	7.2kg	8.4kg	0.2	795x425x550mm
50.350		400x400x770mm			
WIRE D2	QTY	N.W	G.W	C.B.M	SIZE
Packing	1	8.8kg	10.2kg	0.27	795x620x550mm
50.351		600x400x770mm			
WIRE D3	QTY	N.W	G.W	C.B.M	SIZE
Packing	1	13.6kg	15.2kg	0.52	1205x790x550mm
50.352		1000x600x770mm			







PRONG DETAILS INFORMATION *mm

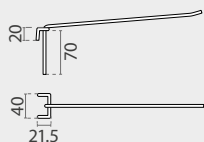

Made using heavy duty chrome finish metal. Lightweight prong for specific using with gridwall.



SINGLE PRONG	SIZE		
50.201	Ø 4x150mm	x100	
50.202	Ø 5x200mm	x100	
50.203	Ø 5x250mm	x100	
50.204	Ø 6x300mm	x100	
50.200	Ø 6x350mm	x100	

SINGLE PRONG HOOK

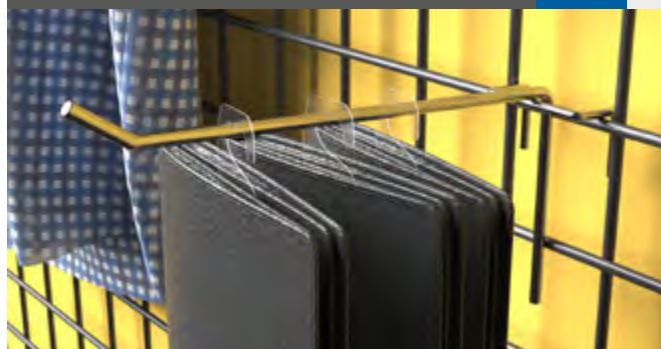





PRONG DETAILS INFORMATION *mm

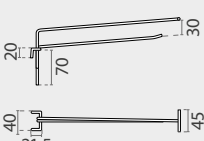

Made using heavy duty chrome finish metal. Stocked in a wide range of sizes. This gridwall prong has price holder overarm included.



SINGLE OVER.	SIZE		
50.232	Ø 4x150mm	x100	
50.233	Ø 5x200mm	x100	
50.234	Ø 5x250mm	x100	
50.235	Ø 6x300mm	x100	
50.256	Ø 6x350mm	x100	

SINGLE PRONG HOOK WITH OVERARM







PRONG DETAILS INFORMATION *mm

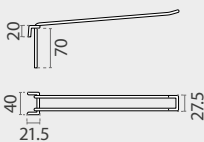

Made using heavy duty chrome finish metal. Double wire makes it sturdier. Designed for using on gridwall panels.



EURO HOOK	SIZE		
50.225	Ø 4x150mm	x100	
50.226	Ø 5x200mm	x100	
50.227	Ø 5x250mm	x100	
50.228	Ø 6x300mm	x100	
50.229	Ø 6x350mm	x100	

EURO HOOK







PRONG DETAILS INFORMATION *mm

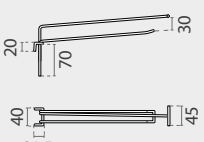

Made using heavy duty chrome finish metal. This gridwall euro prong comes with price holder overarm included.



EURO OVER.	SIZE		
50.529	Ø 4x150mm	x100	
50.530	Ø 5x200mm	x100	
50.531	Ø 5x250mm	x100	
50.532	Ø 6x300mm	x100	

EURO HOOK WITH OVERARM

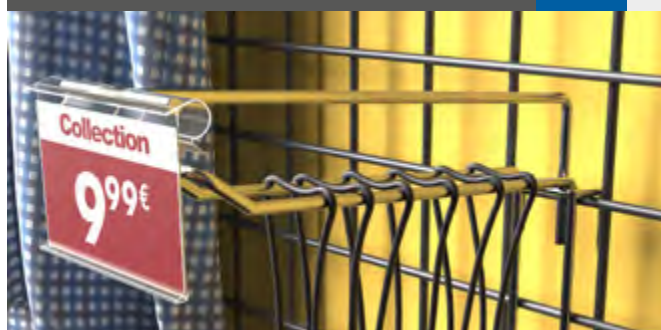

* price holders not included

GONDOLA DETAILS

*mm



INFORMATION

This double sided Slatwal Gondola without wheels allows a maximum exposure of your exhibits. Slatwall aluminium profiles included. Profiles spacing 150mm. This is a versatile display thanks to our wide range of prongs and fixtures available.

GONDOLA	SIZE	
50.159	1000x1500x400mm	x1 

SLATWALL GONDOLA



GONDOLA DETAILS

*mm



INFORMATION

This double sided Slatwal Gondola with wheels allows a maximum exposure of your exhibits. Slatwall aluminium profiles included. Profiles spacing 150mm. This is a versatile display thanks to our wide range of prongs and fixtures available.

ROLL. GONDOLA	SIZE	
50.160	1200x1550x400mm	x1 

ROLLING GONDOLA

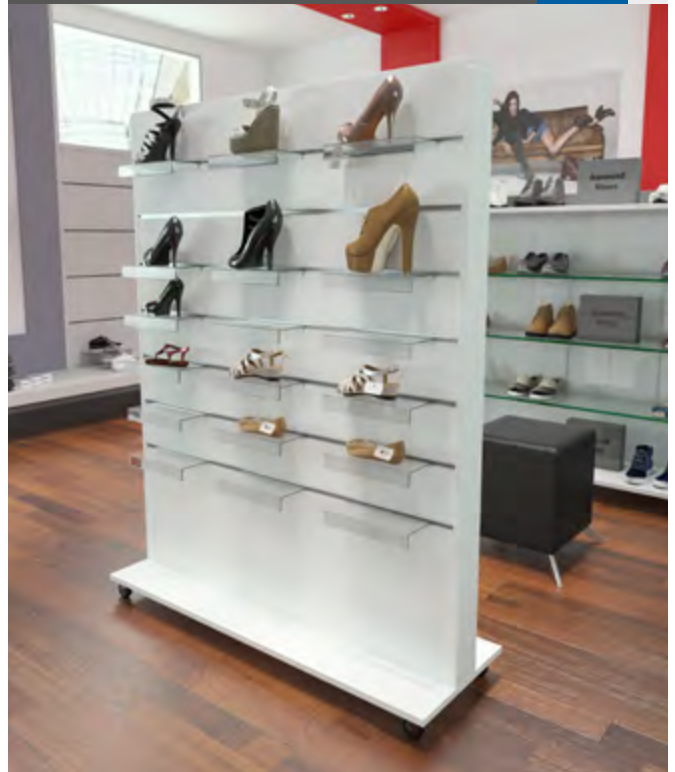



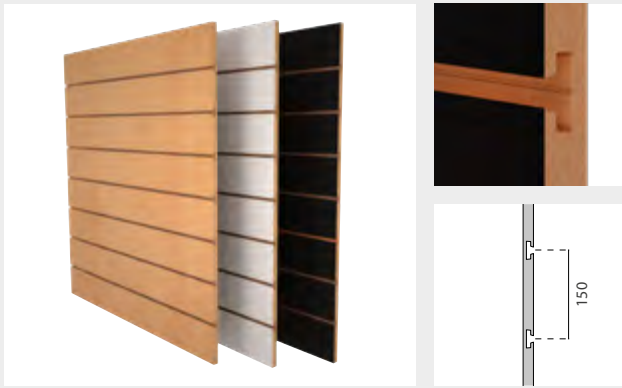

PANELS DETAILS

*mm



INFORMATION

A set of two same color slatwall panels for wall mount use. Milling distance 150mm. Inserts aluminium profiles and perimetral decorative profiles are sold separately.

SLATWALL 150	SIZE		
50.155BN			
50.155WH		1200x1200x19mm	x2 
50.155BK			

SLATWALL PANEL 150





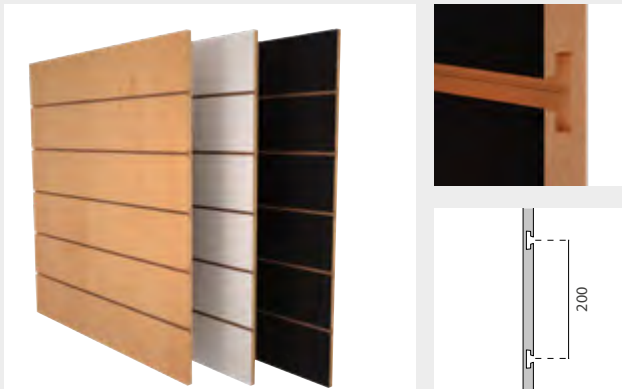

PANELS DETAILS

*mm



INFORMATION

A set of two same color slatwall panels for wall mount use. Milling distance 200mm. Inserts aluminium profiles and perimetral decorative profiles are sold separately.

SLATWALL 200	SIZE		
50.156BN			
50.156WH		1200x1200x19mm	x2 
50.156BK			

SLATWALL PANEL 200



SLATWALL ALUMINIUM PROFILE



Aluminium slatwall profiles that ensures a smooth fit into the slatwall panels and great strength.

ALUM. PROFILE	LENGTH		
50.157	1200mm	x10 	

PERIMETRAL DECORATIVE PROFILE

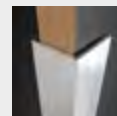

Aluminium profiles for a better finishing of our slatwall panel edges. Available in packs of four pieces.

DECO PROFILE	PROFILE	LENGTH	
50.158	20x20mm	2400mm	x4 



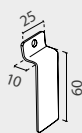

PRONG DETAILS

INFORMATION

*mm



Made using heavy duty metal and chrome finish can be used for years.

SINGLE PRONG	SIZE		
50.131	Ø 4x100mm	x100	
50.001	Ø 5x150mm	x100	
50.002	Ø 5x200mm	x100	
50.003	Ø 6x250mm	x100	
50.004	Ø 6x300mm	x100	

SINGLE PRONG HOOK

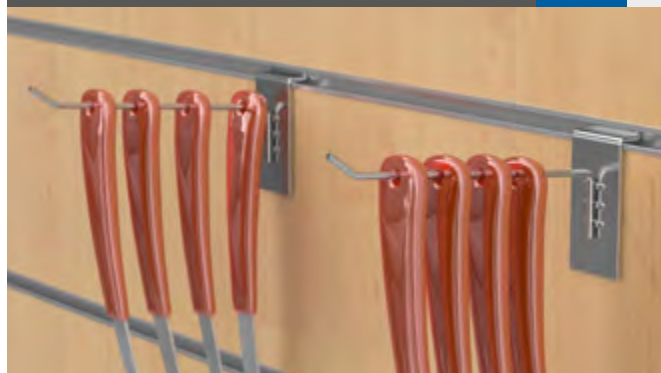



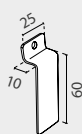

PRONG DETAILS

INFORMATION

*mm



Made using heavy duty metal and chrome finish can be used for years. Overarm included to hang a price holder.

SINGLE OVER.	SIZE		
50.005	Ø 5x150mm	x100	
50.006	Ø 5x200mm	x100	
50.007	Ø 6x250mm	x100	
50.008	Ø 6x300mm	x100	

SINGLE PRONG HOOK WITH OVERARM





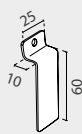

EURO HOOK DETAILS

INFORMATION

*mm



Made using heavy duty metal and chrome finish can be used for years.

EURO HOOK	SIZE		
50.060	Ø 5x150mm	x100	
50.061	Ø 5x200mm	x100	
50.062	Ø 6x250mm	x100	
50.063	Ø 6x300mm	x100	

EURO HOOK





EURO HOOK DETAILS

INFORMATION

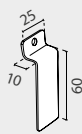
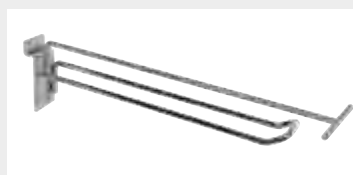
*mm



Made using heavy duty metal and chrome finish can be used for years. Overarm included to hang a price holder.

EURO OVER.	SIZE		
50.359	Ø 5x150mm	x100	
50.360	Ø 5x200mm	x100	
50.361	Ø 5x250mm	x100	

EURO HOOK WITH OVERARM

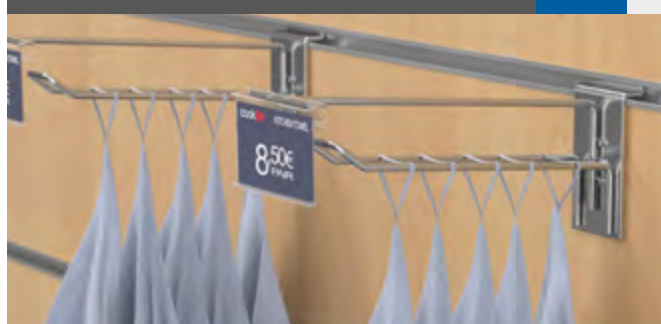

ARM DETAILS



INFORMATION

*mm

Made using heavy duty metal and chrome finish. Ideal for displaying clothes in your retail store, with a ball stop end to secure your products. No tools are required to set up with a slatwall unit.

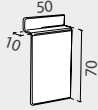

ROUND ARM SIZE

50.033 Ø10x400mm x25 

ROUND STRAIGHT ARM WITH BALL END



ARM DETAILS



INFORMATION

*mm

Made using heavy duty metal and chrome finish. Ideal for displaying clothes in your retail store, with multiple ball stops for spacing your products. No tools are required to set up with a slatwall unit.

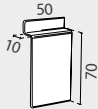

8 BALLS ROUND SIZE

50.034 Ø10x400mm x25 

8 BALLS ROUND STRAIGHT ARM



ARM DETAILS

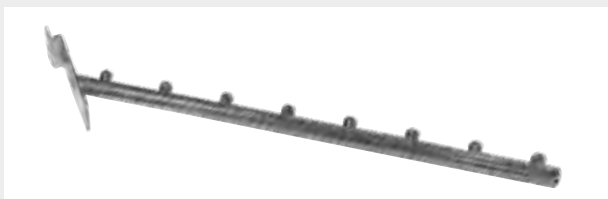

INFORMATION

*mm

Made using heavy duty metal and chrome finish. Ideal for displaying clothes in your retail store, with multiple ball stops for spacing your products. No tools are required to set up with a slatwall unit.

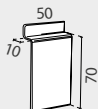

ROUND SLOPING SIZE

50.035 Ø10x400mm x25 

8 BALLS ROUND SLOPING ARM



ARM DETAILS



INFORMATION

*mm

Made using heavy duty flat square oval chrome tube. Ideal for displaying and supporting the weight of various garments, with a ball stop end to secure your products. No tools required to set up with a slatwall unit.

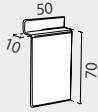

OVAL ARM SIZE

50.036 30x15x400mm x25 

OVAL STRAIGHT ARM WITH BALL END



ARM DETAILS



INFORMATION

*mm

Made using heavy duty flat square oval chrome tube. Ideal for displaying and supporting the weight of various garments, with multiple ball stops for spacing your products. No tools required to set up with a slatwall unit.

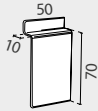

8 BALLS OVAL SIZE

50.037 30x15x400mm x25 

8 BALLS OVAL STRAIGHT ARM



ARM DETAILS

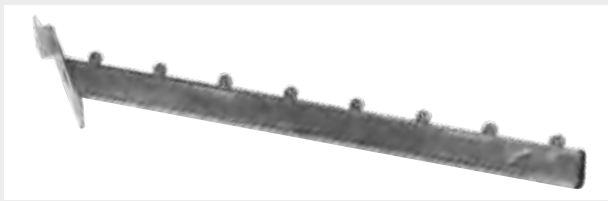

INFORMATION

*mm

Made using heavy duty flat square oval chrome tube. Ideal for displaying and supporting the weight of various garments, with multiple ball stops for spacing your products. No tools required to set up with a slatwall unit.

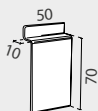

OVAL SLOPING SIZE

50.038 30x15x400mm x25 

8 BALLS OVAL SLOPING ARM



ARM DETAILS

INFORMATION *mm

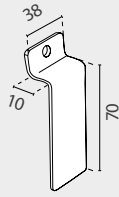

Made using heavy duty chrome finish metal. It is the ideal accessory for displaying balls or sport equipment.

BALL DISPLAY

SIZE

50.085

Ø150mm

x10 

BALL RISING DISPLAY ARM

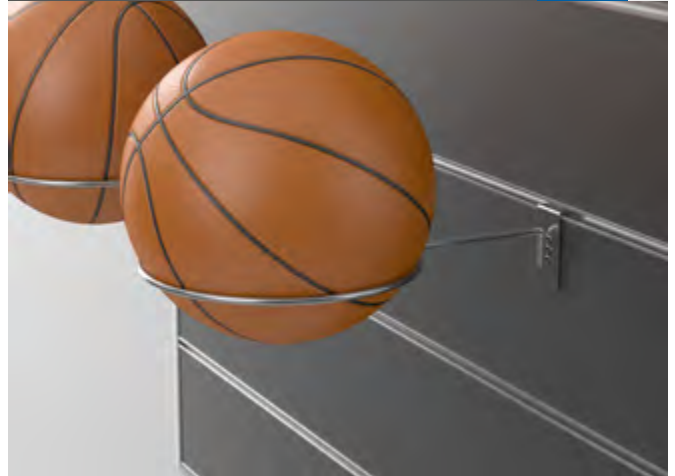

ARM DETAILS

INFORMATION *mm

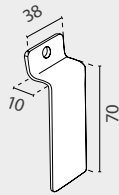

Made using heavy duty chrome finish metal. This ring is the ideal accessory for displaying baseballs caps easily.

CAP DISPLAY

SIZE

50.087

Ø150mm

x10 

BASEBALL CAP DISPLAY ARM



ARM DETAILS

INFORMATION *mm

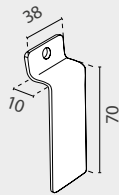

Made using heavy duty chrome finish metal. This ring is the ideal accessory for displaying hats in your store easily.

HAT DISPLAY

SIZE

50.086

Ø150mm

x10 

HAT DISPLAY ARM



PRONG DETAILS

INFORMATION *mm

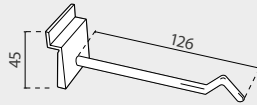

White plastic hook clip for attaching to slatwall panels. Ideal for hanging strips or lightweight products.

SLAT PRONG	SIZE	
12.111	126mm	x50 

SLAT WALL PRONG



HOLDER DETAILS

INFORMATION *mm



Specific accessory for presenting glasses on your slat panel. This fixture slide into the slat panels without adhesives or tools. Made of a durable transparent plastic.

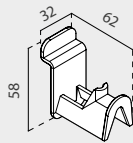

GLASSES HOLDER	SIZE	
50.858	32x58x62mm	x25 

GLASSES HOLDER FOR SLATWALL PANEL



TRAY DETAILS

INFORMATION *mm

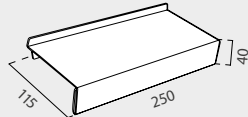

This slat wall shelving is a great addition to any slatwall display. Front folding to add a price label.

CARRY TRAY	SIZE	
50.097	250x40x115mm	x10 

PLASTIC CARRY TRAY





BRACKET DETAILS

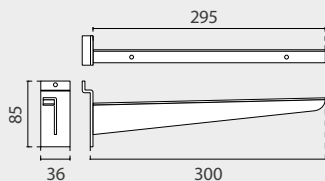

INFORMATION *mm

Heavy duty metal shelf chrome finish brackets, made to fit to slatwall panels. It is suitable for glass, acrylic or wooden shelves. Supplied in pairs, one left and one right.



SHELF BRACKET	SIZE	
50.069	295x85mm	x2 
		 1 Uni
		 1 Uni

SHELF BRACKET 300mm (LEFT AND RIGHT)



PANEL DETAILS

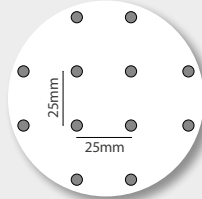
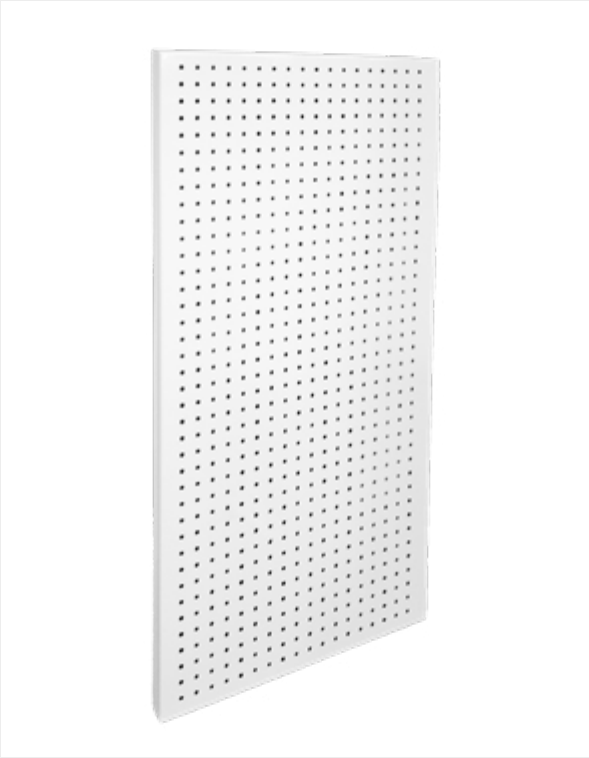

INFORMATION

This Pegboard panel with 25mm slotting pattern is an excellent display system. Heavy duty metal construction. Rear mounting slots for vertical or horizontal installation. See our range of pegboard prongs to attach directly without tools.

PEGBOARD	SIZE	SLOTING PATTERN
50.420	500x2000mm	25mm
50.421	1000x2000mm	25mm
50.422	1000x500mm	25mm
50.423	1200x1200mm	25mm

PEGBOARD PANELS

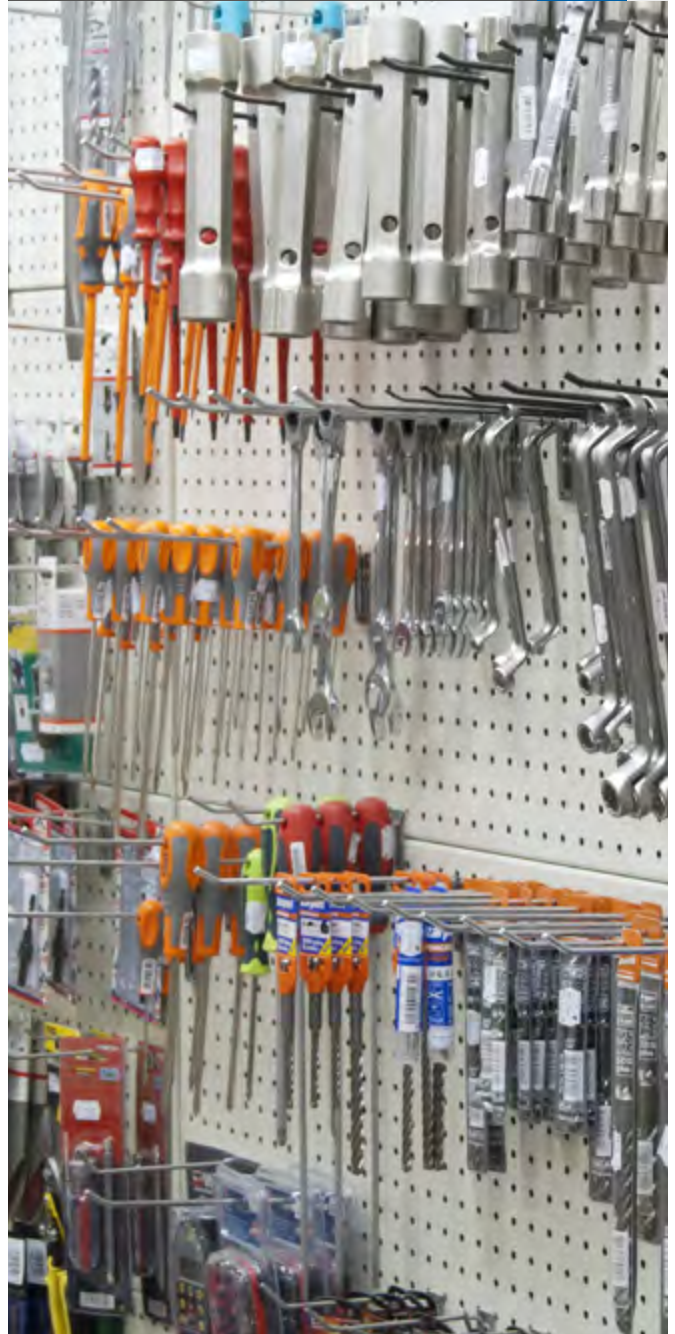

PLATE DETAILS

INFORMATION

*mm



This mounting plate is designed for securing the pegboard panels to vertical surfaces, usually used on the retail store walls. 4 wall mounting plates per each pegboard panel is recommended.

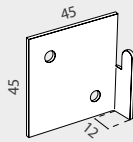

MOUNT PLATE

SIZE

50.430	30x15x40mm	x4  (2 left + 2 right)
--------	------------	---

PEGBOARD MOUNTING PLATE

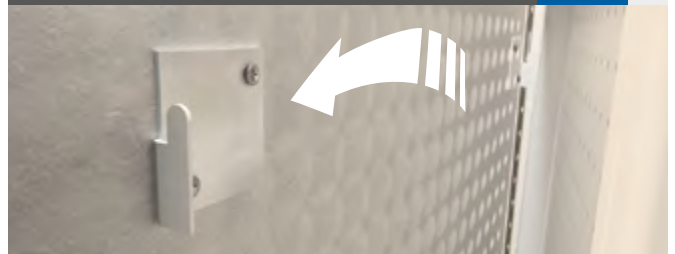

PRONG DETAILS

INFORMATION

*mm

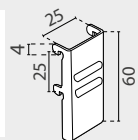

Made using heavy duty chrome finish metal. It is suitable for 25mm slotting pattern pegboard.

SINGLE PRONG	SIZE		
50.059	Ø 4x100mm	x100	
50.019	Ø 5x150mm	x100	
50.020	Ø 5x200mm	x100	
50.021	Ø 6x250mm	x100	
50.022	Ø 6x300mm	x100	
50.023	Ø 6x350mm	x100	

SINGLE PRONG HOOK





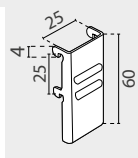

PRONG DETAILS

INFORMATION

*mm



Made using heavy duty chrome finish metal. It is suitable for 25mm slotting pattern pegboard. Overarm to price holder is included.

SINGLE OVER.	SIZE		
50.024	Ø 5x150mm	x100	
50.025	Ø 5x200mm	x100	
50.026	Ø 6x250mm	x100	
50.027	Ø 6x300mm	x100	
50.028	Ø 6x350mm	x100	

SINGLE PRONG HOOK WITH OVERARM





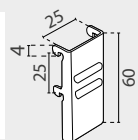

PRONG DETAILS

INFORMATION

*mm



Made using heavy duty chrome finish metal. It is suitable for 25mm slotting pattern pegboard.

EURO HOOK	SIZE		
50.029	Ø 5x150mm	x100	
50.030	Ø 5x200mm	x100	
50.031	Ø 6x250mm	x100	
50.032	Ø 6x300mm	x100	

EURO HOOK





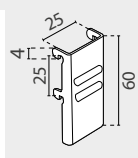
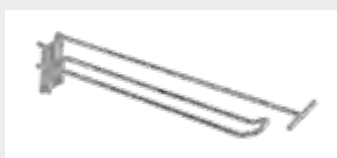

PRONG DETAILS

INFORMATION

*mm



Made using heavy duty chrome finish metal. It is suitable for 25mm slotting pattern pegboard. Overarm to price holder is included.

EURO OVER.	SIZE		
50.355	Ø 5x150mm	x100	
50.356	Ø 5x200mm	x100	
50.357	Ø 6x250mm	x100	
50.358	Ø 6x300mm	x100	

EURO HOOK WITH OVERARM





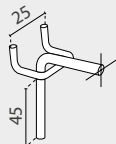

PRONG DETAILS

INFORMATION

*mm



Made using heavy duty chrome finish metal. It is suitable for 25mm slotting pattern pegboard.

SINGLE WIRE	SIZE		
50.009	Ø 4x100mm	x100	
50.010	Ø 5x150mm	x100	
50.011	Ø 5x200mm	x100	
50.012	Ø 5x250mm	x100	
50.013	Ø 6x300mm	x100	

SINGLE WIRE HOOK





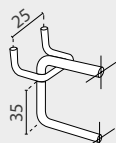

PRONG DETAILS

INFORMATION

*mm



Made using heavy duty chrome finish metal. It is suitable for 25mm slotting pattern pegboard. Overarm to price holder is included.

SINGLE OVER.	SIZE		
50.014	Ø 4x100mm	x100	
50.015	Ø 4x150mm	x100	
50.016	Ø 5x200mm	x100	
50.017	Ø 5x250mm	x100	
50.018	Ø 6x300mm	x100	

SINGLE WIRE HOOK WITH OVERARM



PRONG DETAILS

INFORMATION

*mm

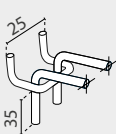

Made using heavy duty chrome finish metal. It is suitable for 25mm slotting pattern pegboard.

EURO WIRE	SIZE		
50.070	Ø 4x150mm	x100	
50.071	Ø 5x200mm	x100	
50.072	Ø 5x250mm	x100	
50.073	Ø 6x300mm	x100	

EURO WIRE HOOK





PRONG DETAILS

INFORMATION

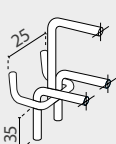
*mm



Made using heavy duty chrome finish metal. It is suitable for 25mm slotting pattern pegboard. Overarm to price holder is included.

EURO OVER.	SIZE		
50.079	Ø 5x150mm	x100	
50.076	Ø 5x200mm	x100	
50.077	Ø 5x250mm	x100	
50.078	Ø 5x300mm	x100	

EURO WIRE HOOK WITH OVERARM

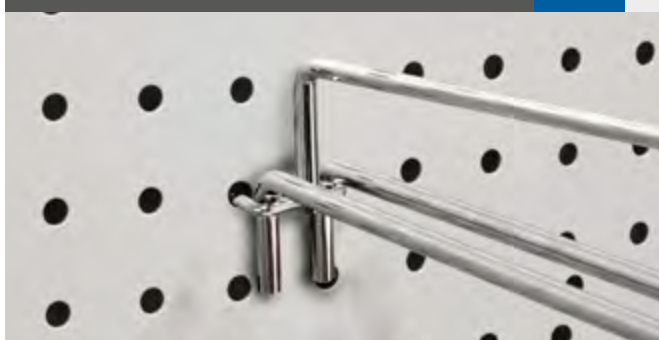

PRONG DETAILS

*mm

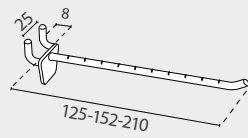

INFORMATION

This simple prong made from sturdy plastic with notches along the hook to assist with even spacing of items, enhancing your products and display. It is suitable for 25mm slotting pattern pegboard and for slatwall.

EURO OVER.	LENGHT		
12.255	125mm	x50 	
12.256	152mm	x50 	
12.257	210mm	x50 	

SIMPLE PEGBOARD PRONG



PRONG DETAILS

*mm

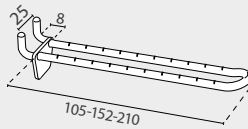

INFORMATION

This double prong made from sturdy plastic with notches along the hook to assist with even spacing of items, enhancing your products and display. It is suitable for 25mm slotting pattern pegboard and for slatwall.

EURO OVER.	LENGHT		
12.252	105mm	x50 	
12.253	152mm	x50 	
12.254	210mm	x50 	

DOUBLE PEGBOARD PRONG



PRONG DETAILS

INFORMATION

*mm

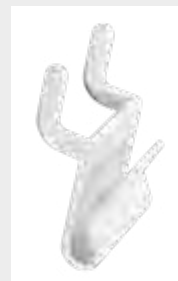

This white simple white clip hook is made from sturdy plastic. It is 48mm length and it is suitable for being attaching to the pegboard panels. Ideal for hanging plastic strips, coupons, small objects or for any other temporary promotional offer at your business.

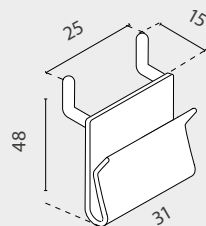

SIMPLE HOOK	SIZE		
12.483	31x48mm	x100 	

PEGBOARD SIMPLE HOOK



BACK RAIL SYSTEM Back Rail Arms

RAIL DETAILS



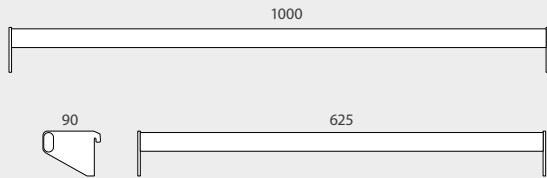

INFORMATION

*mm



Made from steel tube is ideal for displaying and supporting the weight of various garments. Quick and easy to install is compatible with our wide range of accessories.

BACK RAIL	SIZE		
50.045	30x15x625mm	x25	
50.046	30x15x1000mm	x25	

OVAL BACK RAIL



RAIL DETAILS



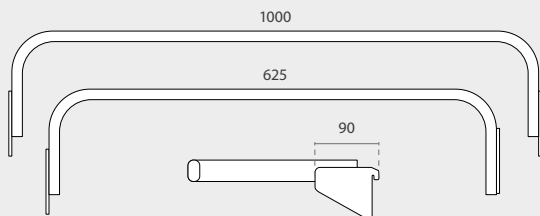

INFORMATION

*mm



Made from steel. It is ideal for displaying and supporting the weight of various garments. With an easy set-up and compatible with our wide range of accessories.

"D" BACK RAIL	SIZE		
50.048	30x15x625mm	x25	
50.049	30x15x1000mm	x25	

OVAL "D" BACK RAIL



BACK RAIL SYSTEM Back Rail Arms

ARM DETAILS



INFORMATION

*mm

Made using heavy duty metal and chrome finish. Ideal for displaying clothes in your retail store, with a ball stop end to secure your products. Suitable for shelving back rail.



ROUND ARM

SIZE

50.039

Ø15X400mm

x25



ROUND STRAIGHT ARM WITH BALL END

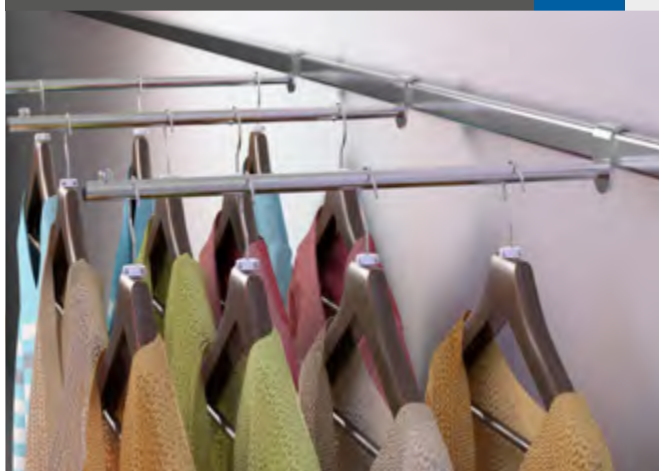

ARM DETAILS



INFORMATION

*mm

Made using heavy duty metal and chrome finish. Ideal for displaying clothes, with multiple ball stops for spacing your products. Suitable for shelving back rail.

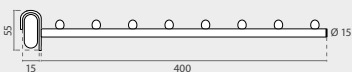

8 BALLS ROUND

SIZE

50.040

Ø15X400mm

x25



8 BALLS ROUND STRAIGHT ARM

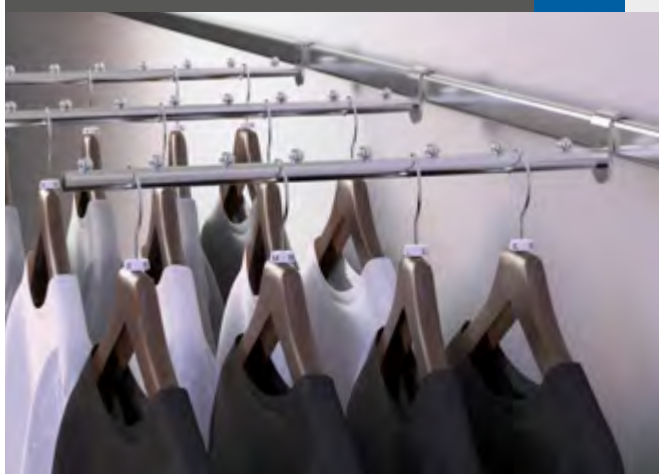

ARM DETAILS



INFORMATION

*mm

Made using heavy duty metal and chrome finish. Ideal for displaying clothes, with multiple ball stops for spacing your products. Suitable for shelving back rail.

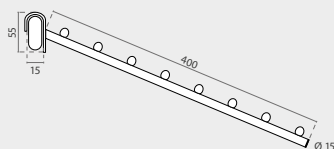

ROUND SLOPING

SIZE

50.041

Ø15X400mm

x25



8 BALLS ROUND SLOPING ARM

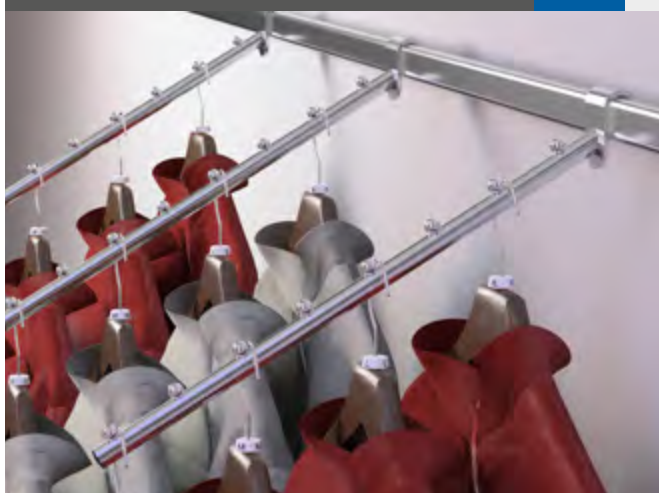

BACK RAIL SYSTEM Back Rail Arms

ARM DETAILS



INFORMATION

*mm

Straight design made of heavy duty metal with a chromed finish and a ball stop end to secure your products. Ideal for displaying clothes. Suitable for shelving back rail.

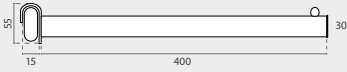

ROUND ARM

SIZE

50.042

30x15x400mm

x25



OVAL STRAIGHT ARM WITH BALL END



ARM DETAILS



INFORMATION

*mm

Straight design made of heavy duty metal with a chromed finish and multiple ball stops for spacing your products. Ideal for displaying clothes. Suitable for shelving back rail.

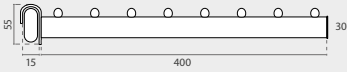

8 BALLS OVAL

SIZE

50.043

30x15x400mm

x25



8 BALLS OVAL STRAIGHT ARM



ARM DETAILS



INFORMATION

*mm

Sloping design made of heavy duty metal with a chromed finish and multiple ball stops for spacing your products. Ideal for displaying clothes. Suitable for shelving back rail.

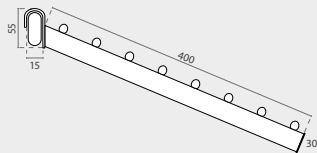

OVAL SLOPING

SIZE

50.044

30x15x400mm

x25



8 BALLS OVAL SLOPING ARM

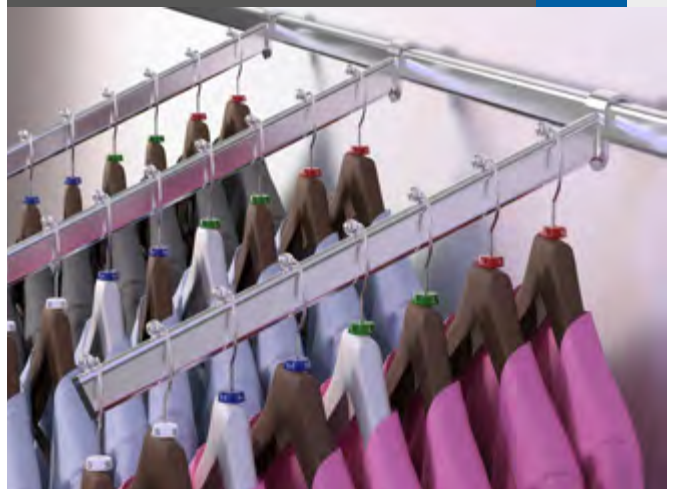

BACK RAIL SYSTEM Back Rail Prongs

PRONG DETAILS

INFORMATION

*mm

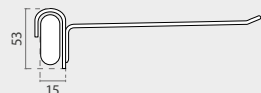

Made using heavy duty metal with chrome finish. This prong is suitable for shelving back bar rail.

SINGLE PRONG

SIZE

50.051	Ø 5x200mm	x100 	
50.052	Ø 6x250mm	x100 	
50.053	Ø 6x300mm	x100 	
50.054	Ø 6x350mm	x100 	

SINGLE PRONG HOOK



PRONG DETAILS

INFORMATION

*mm

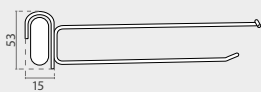

Made using heavy duty chrome finish metal. Suitable for shelving backrail with priceholder overarm.

SINGLE OVER.

SIZE

50.064	Ø 5x200mm	x100 	
50.065	Ø 6x250mm	x100 	
50.066	Ø 6x300mm	x100 	
50.067	Ø 6x350mm	x100 	

SINGLE PRONG HOOK WITH OVERARM



PRONG DETAILS

INFORMATION

*mm

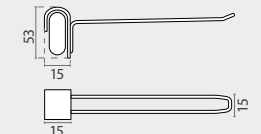

Made using heavy duty metal with chrome finish. This prong is suitable for shelving back bar rail.

EURO HOOK

SIZE

50.055	Ø 5x200mm	x100 	
50.056	Ø 6x250mm	x100 	
50.057	Ø 6x300mm	x100 	
50.058	Ø 6x350mm	x100 	

EURO HOOK

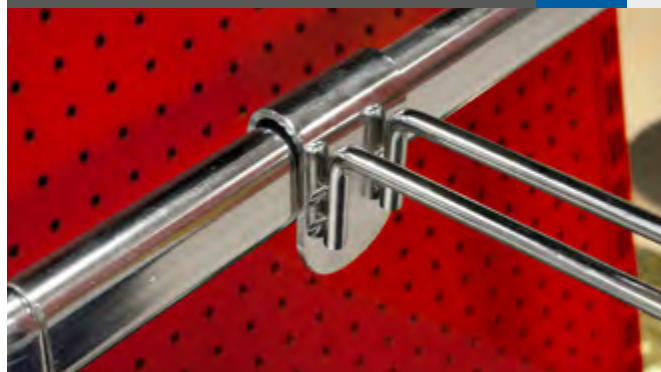

PRONG DETAILS

INFORMATION

*mm

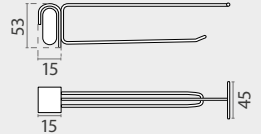

Made using heavy duty chrome finish metal. Suitable for shelving backrail with priceholder overarm.

EURO OVER.

SIZE

50.456	Ø 5x200mm	x100 	
50.457	Ø 5x250mm	x100 	
50.458	Ø 6x300mm	x100 	

EURO HOOK WITH OVERARM



HOLDER DETAILS

INFORMATION

*mm



Clear extruded PVC sign holder for hooks with T ended overarms. Available in 3 different lengths. This straight price holder is ideal for displaying sales and prices on hooks.

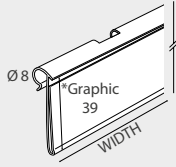

STRAIGHT	WIDTH		
50.107	53mm	x100 	
50.100	65mm	x100 	
50.101	105mm	x100 	

STRAIGHT PRICE HOLDER FOR HOOKS



HOLDER DETAILS



INFORMATION

*mm

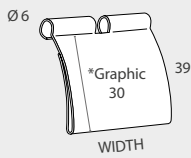

Clear extruded PVC sign holder for hooks with T ended overarms. Available in 2 different lengths. This straight price holder is ideal for displaying sales and prices on hooks.



STRAIGHT	WIDTH		
50.102	53mm	x100 	
50.109	65mm	x100 	

CURVED PRICE HOLDER FOR HOOKS



HOLDER DETAILS

INFORMATION

*mm



This overarm label holder is made of transparent plastic and it has a space for inserting the promotion card or label price (27x31mm).

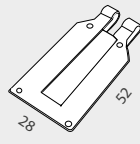

OVERARM LABEL	GRAPHIC SIZE		
50.123	27x31mm	x100 	

OVERARM LABEL HOLDER



HOLDER DETAILS

INFORMATION

*mm



This label holder is made of transparent plastic. It has space to insert promotions or price labels (size: 27x31mm). It is ideal for the euro hooks.

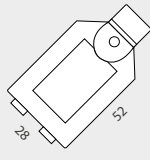

EURO LABEL	GRAPHIC SIZE		
50.119	27x31mm	x100 	

EURO HOOK LABEL HOLDER



GRIPPER DETAILS

INFORMATION

*mm



This front gripper is made of transparent plastic and it has a gripper for attaching price labels. It is ideal for placing in front of hooks or wire baskets.

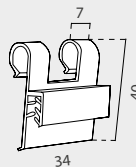

FRONT GRIPPER	SIZE		
12.230	34x40mm	x100 	

HOOK FRONT GRIPPER



GRIPPER DETAILS

INFORMATION

*mm



This hook stopper is made of transparent plastic and has a gripper for attaching promotion cards or price labels in front of the prongs.

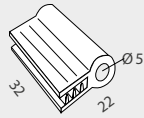

STOPPER GRIPPER

LENGTH

12.450

32mm

x100 

HOOK STOPPER GRIPPER



LIMITER DETAILS

INFORMATION

*mm



This rounded stock limiter is ideal for reducing the stock amount on the prong and also, for keeping organized the products among the prongs.



ROUND LIMITER

DIAMETER

12.280

Ø26mm

x100 

ROUND STOCK LIMITER



LIMITER DETAILS

INFORMATION

*mm



Used to delimit and manage stock in prongs. Attaches and detaches quickly and easily. It is designed to fit on hooks 6-7mm diameter.

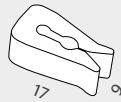

SIMPLE LIMITER

SIZE

12.282

9X17mm

x100 

SIMPLE HOOK STOCK LIMITER



LIMITER DETAILS

INFORMATION

*mm



This stock limiter is ideal for holding merchandise forward on hook and keeping products organized. Fits on Double Prong Eurohook.



DOUBLE LIMITER

DIAMETER

12.281

Ø26mm

x100 

DOUBLE HOOK STOCK LIMITER



LIMITER DETAILS

INFORMATION

*mm



This stock limiter made of clear plastic is ideal for reducing the stock amount on the prongs. And it is suitable for hooks diameter from 4 to 8mm.

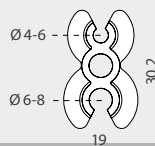

MULTI LIMITER

HOOK DIAMETER

12.549

Ø4-8mm

x50 

MULTI HOOK STOCK LIMITER



HANGER DETAILS

INFORMATION

*mm



Made of 0.04mm PVC and it has a front adhesive. Ideal for hanging foam board, cardboard, posters on walls, ceiling or hanging from prongs.

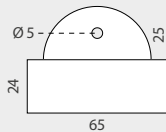

PVC HANGER

SIZE

12.512

65x49mm

x50 

ADHESIVE PVC HANGER



HANG TAB DETAILS

INFORMATION

*mm



The Euroslot clear plastic hang tab is designed for hanging products on prongs. Max. recommended weight of 450 grams.

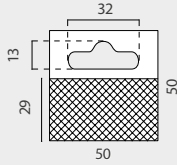

EUROSLOT	SIZE	MAX. WEIGHT	
12.357	50x50mm	450 g.	x100 

EUROSLOT



HANG TAB DETAILS

INFORMATION

*mm



The Standard clear plastic hang tab is designed for hanging products on prongs. Max. recommended weight of 110 grams.

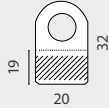

STANDARD	SIZE	MAX. WEIGHT	
12.358	20x32mm	110 g.	x100 

STANDARD



HANG TAB DETAILS

INFORMATION

*mm



The Flexi transparent plastic hang tab is designed for hanging products on prongs. Max. recommended weight of 230 grams.

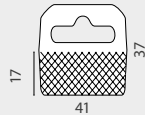

FLEXI	SIZE	MAX. WEIGHT	
12.359	41x37mm	230 g.	x100 

FLEXI



HANG TAB DETAILS

INFORMATION

*mm



The Hook transparent plastic hang tab is designed for hanging products on prongs. Max. recommended weight of 120 grams.

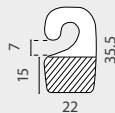

HOOK	SIZE	MAX. WEIGHT	
12.360	22x35.5mm	120 g.	x100 

HOOK



HANG TAB DETAILS

INFORMATION

*mm



Easy transparent plastic hang tab is designed for hanging products on prongs. Max. recommended weight of 185 grams.

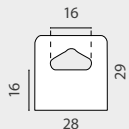

EASY	SIZE	MAX. WEIGHT	
12.361	28x29mm	185 g.	x100 

EASY



HANG TAB DETAILS

INFORMATION

*mm



The Nova transparent plastic hang tab is designed for hanging products on prongs. Max. recommended weight of 400 grams.

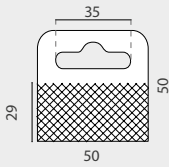

NOVA	SIZE	MAX. WEIGHT	
12.362	50x50mm	400 g.	x100 

NOVA



HANG TAB DETAILS

INFORMATION

*mm



The Folding clear plastic hang tab is designed for hanging products on prongs. Max. recommended weight of 230 grams..

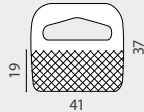

FOLDING	SIZE	MAX. WEIGHT	
12.363	41x37mm	230 g.	x100 

FOLDING



HANG TAB DETAILS

INFORMATION

*mm



The Quick plastic hang tab is designed for hanging products on prongs. Max. recommended weight of 400 grams..

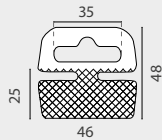

QUICK	SIZE	MAX. WEIGHT	
12.364	46x48mm	400 gr.	x100 

QUICK

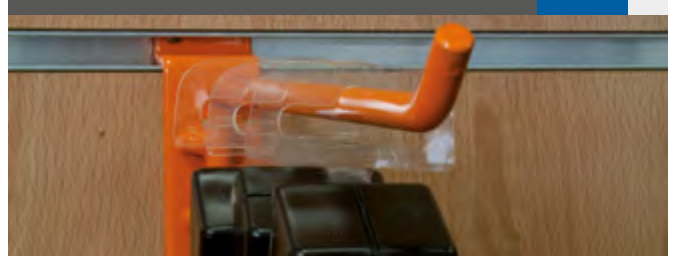

HANG TAB DETAILS

INFORMATION

*mm



The Use transparent plastic hang tab is designed for hanging products on prongs. Max. recommended weight of 400 grams.

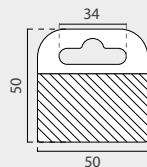

USE	SIZE	MAX. WEIGHT	
12.632	50x50mm	400 g.	x100 

USE



HANG TAB DETAILS

INFORMATION

*mm



The Hangtab made of transparent plastic is ideal for repairing or reinforcing hang tabs.

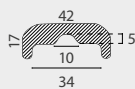

HANGTAB	SIZE	MAX. WEIGHT	
12.366	42x17mm	400 g.	x100 

HANGTAB













LOCK DETAILS



INFORMATION

This magnetic lock for prongs from 6 to 8mm diameter is an affordable, effective, and easy to use theft deterrent device. Available in black or white.

LOCK	COLOURS	MAX. HOOK DIAMETER			
50.365	 	6mm	 	x25	
50.367	 	8mm	 	x25	

MAGNETIC LOCK FOR SINGLE HOOK



LOCK DETAILS



INFORMATION

This magnetic lock for euro hook is an affordable, effective, and easy to use theft deterrent device. Available in black or white.

STOPLOCK	COLOUR	SIZE			
50.369	 	45x35mm	 	x25	

STOPLOCK FOR DOUBLE HOOK



LOCK DETAILS



INFORMATION

This is a handy compact detacher with a handy clip for attaching to keys or work pass. Place this detacher at bottom of magnetic lock to unlock.

STOPLOCK	SIZE			
50.368	45x35mm		x1	

DETACHER MINI STOPLOCK

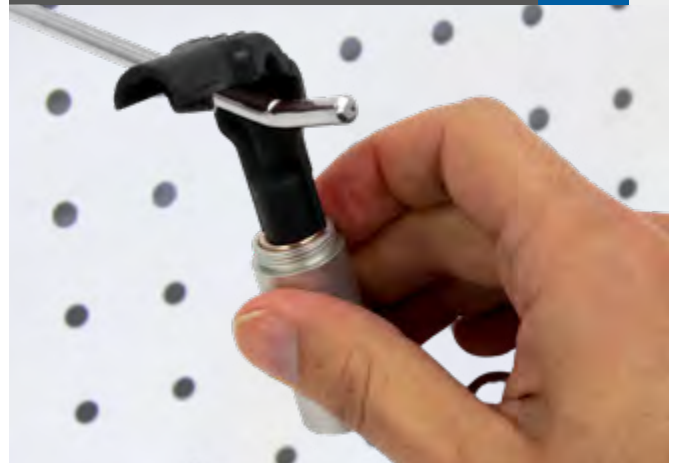

LOCK DETAILS

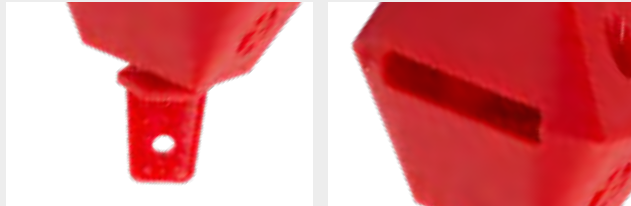

INFORMATION

*mm

These hooks are an affordable, effective, and easy-to-use theft deterrent device. It includes key lock. Cap covers the end of the hook. Ideal for retail shops, digital stores, cell phone stores, book stores, pharmacies or shopping malls.

END'S LOCK	SIZE		
12.528	65x50x25mm		x20 

HOOK END'S LOCK
FOR EURO HOOK



LOCK DETAILS



INFORMATION

*mm

These hooks are an affordable, effective, and easy-to-use theft deterrent device. It includes key lock. Red color finish. Ideal for retail shops, digital stores, cell phone stores, book stores, pharmacies or shopping malls.

END'S LOCK	SIZE		
12.529	46x42x15mm		x20 

HOOK LOCK
FOR EURO HOOK



BACK HOOK DETAILS



50.386	Length: 180mm	x25 
50.387	Length: 180mm	x25 
50.394	Length: 180mm	x25 
50.395	Length: 240mm	x25 
50.391	Length: 180mm	x25 
50.392	Length: 240mm	x25 

SECURITY HOOK FOR SLATWALL, PLATE OR PEGBOARD



DETACHER DETAILS



This security system allows you to unlock quickly and easily any of the security hooks for inserting or removing the products.

DIMENSIONS

50.396	118x23x20mm
--------	-------------

DETACHER SECURITY HOOK LOCK





OPTICAL TAG



TAG DETAILS



Optical tag for all styles of optical and fashion eyeglasses and sunglasses, Mechanical Lock - requires optical tag detacher (sold separately). Available for 2 different radio frequencies and in white or light grey finish.

	COLOR	FREQUENCY	DIMENSIONS	
50.389	<input type="checkbox"/> <input checked="" type="checkbox"/>	RF 8.2MHZ	22x24x26mm	x25 
50.399	<input type="checkbox"/> <input checked="" type="checkbox"/>	AM 58Khz	22x24x26mm	x25 

OPTICAL TAG DETACHER



DETACHER DETAILS



This screwdriver shaped detacher allows the fast and easily opening of the optical tag system for glasses (ref 50389 and 50399). The optical tag is locked by a small screw driver to lock the glasses frame tight and also, it can be released or unlocked by the Optical Tag Detacher.

	LENGTH
50.379	95mm



LOCKABLE OPTICAL DISPLAY ROD

DISPLAY DETAILS



DISPLAY DETAILS

DIMENSIONS

*mm

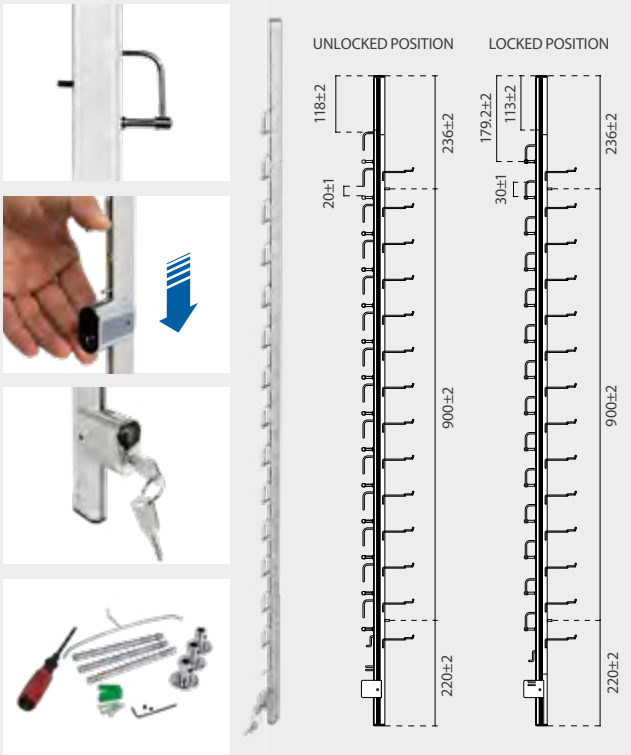

This Lockable Optical Display Rod includes: 1 Bar, 3 Bar Support + Anchorage, 14 Support for glasses, 1 temples, 1 Screwdriver, 1 Allen key, 2 Key for lock system, screws and plugs. Ideal to expose the glasses in your store and without theft risks. Suitable for displaying 14 glasses.

HEIGHT

50.440

1356mm

x10 



LINE PROFILES Junction Profiles

PROFILE DETAILS



INFORMATION

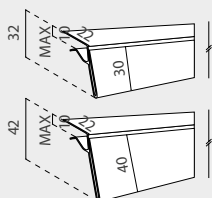

*mm

This shelf profile is suitable for being used with 30mm or 40mm height labels and it allows to be fitted on most of the standard glass shelves. It is ideal for improvising the overall look of the shelf fronts, showcases and for highlighting the promotions of products for sale.



REF
50.265
50.266

REF
50.270
50.271

GLASS	COLOR	LENGTH	GRAPHIC HEIGHT	
50.265		1000mm	30mm	x25 
50.266		1320mm	30mm	x25 
50.270		1000mm	40mm	x25 
50.271		1320mm	40mm	x25 

GLASS PRICE HOLDER PROFILE



PROFILE DETAILS





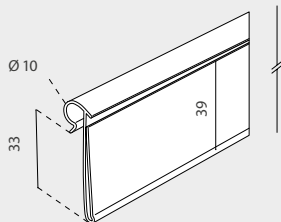

INFORMATION

*mm

This Price Holder Profile is suitable for being used with 39mm height labels and Ø10mm wire shelves. There are 2 Holder Profile lengths available and white or transparent to choose from. It is ideal for improvising the overall look of the shelf fronts, wire dumpbins, wire baskets and for highlighting the promotions of products for sale.



WIRE	COLOR	LENGTH	GRAPHIC HEIGHT	
50.219		1000mm	39mm	x25 
50.220		1320mm	39mm	x25 

WIRE PRICE HOLDER PROFILE



PROFILE DETAILS



INFORMATION

*mm

This shelf profile is suitable for being used with 30mm height labels and it allows to be fitted on most of the standard shelf fronts thanks to its adhesive strip at the top. There are two profile lengths available and white or transparent to choose from. It is ideal for improving the overall look of the shelf fronts in the store and for highlighting the promotions of the products for sale.

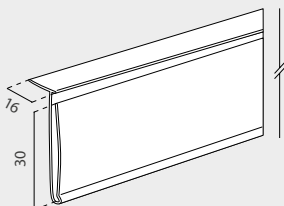

L-30	COLOR	LENGTH	GRAPHIC HEIGHT	
50.222	<input type="checkbox"/> <input checked="" type="checkbox"/>	1000mm	30mm	x25 
50.221	<input type="checkbox"/> <input checked="" type="checkbox"/>	1320mm	30mm	x25 

L-30 ADHESIVE PROFILE



PROFILE DETAILS





INFORMATION

*mm

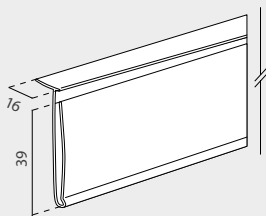
This shelf profile is suitable for being used with 39mm height labels and it allows to be fitted on most of the standard shelf fronts thanks to its adhesive strip at the top. There are 3 profile lengths available and white or transparent to choose from. Ideal for improving the overall look of the shelf fronts in the store and for highlighting the promotions of the products for sale.



L-39	COLOR	LENGTH	GRAPHIC HEIGHT	
50.223	<input type="checkbox"/> <input checked="" type="checkbox"/>	1000mm	39mm	x25 
50.224	<input type="checkbox"/> <input checked="" type="checkbox"/>	1320mm	39mm	x25 
50.117	<input type="checkbox"/> <input checked="" type="checkbox"/>	2700mm	39mm	x25 

L-39 ADHESIVE PROFILE



PROFILE DETAILS

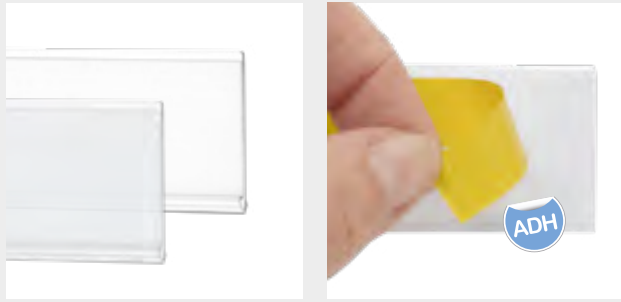

INFORMATION

*mm

This shelf profile is suitable for being used with 26mm height labels and it allows to be fitted on most of the standard shelf fronts thanks to its double adhesive strips at the back. There are 3 profile lengths available and white or transparent to choose from. Ideal for improving the overall look of the shelf fronts in the store and for highlighting the promotions of the products for sale.

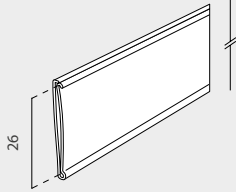

A-26	COLOR	LENGTH	GRAPHIC HEIGHT	
50.211	<input type="checkbox"/> <input checked="" type="checkbox"/>	1000mm	26mm	x25 
50.212	<input type="checkbox"/> <input checked="" type="checkbox"/>	1320mm	26mm	x25 
50.268	<input type="checkbox"/> <input checked="" type="checkbox"/>	2700mm	26mm	x25 

A-26 ADHESIVE PROFILE



PROFILE DETAILS



INFORMATION

*mm

This shelf profile is suitable for being used with 30mm height labels and it allows to be fitted on most of the standard shelf fronts thanks to its double adhesive strips at the back. There are 3 profile lengths available and white or transparent to choose from (transparent only for 1000mm and 1320mm). Ideal for improving the overall look of the shelf fronts and for highlighting the promotions of products for sale.

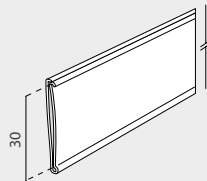

A-30	COLOR	LENGTH	GRAPHIC HEIGHT	
50.213	<input type="checkbox"/> <input checked="" type="checkbox"/>	1000mm	30mm	x25 
50.214	<input type="checkbox"/> <input checked="" type="checkbox"/>	1320mm	30mm	x25 
50.114	<input type="checkbox"/> <input checked="" type="checkbox"/>	2700mm	30mm	x25 

A-30 ADHESIVE PROFILE



PROFILE DETAILS



INFORMATION

*mm

This shelf profile is suitable for being used with 40mm height labels and it allows to be fitted on most of the standard shelf fronts thanks to its double adhesive strips at the back. There are 3 profile lengths available and white or transparent to choose from. Ideal for improving the overall look of the shelf fronts in the store and for highlighting the promotions of the products for sale.

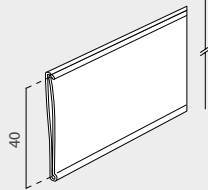

A-40	COLOR	LENGTH	GRAPHIC HEIGHT	
50.208		1000mm	40mm	x25 
50.209		1320mm	40mm	x25 
50.210		2700mm	40mm	x25 

A-40 ADHESIVE PROFILE



PROFILE DETAILS



INFORMATION

*mm

This shelf profile is suitable for being used with 60mm height labels and it allows to be fitted on most of the standard shelf fronts thanks to its double adhesive strips at the back. There are 3 profile lengths available and white or transparent to choose from. Ideal for improving the overall look of the shelf fronts in the store and for highlighting the promotions of the products for sale.

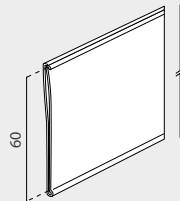

A-60	COLOR	LENGTH	GRAPHIC HEIGHT	
50.215		1000mm	60mm	x25 
50.216		1320mm	60mm	x25 
50.217		2700mm	60mm	x25 

A-60 ADHESIVE PROFILE



STOPPER DETAILS





INFORMATION

This transparent Stopper with hinge features a remarkable curved shape and a 1000mm length. Also it is suitable for being used with 120mm height labels and it allows to be fitted on most of the standard shelf profiles thanks to its hinged gripper at the top. Ideal for improvising the overall look of the shelf fronts and for highlighting the promotions of products for sale.

DIMENSIONS

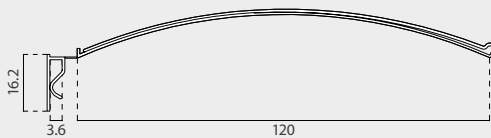
*mm



CURVED H.	COLOR	LENGTH	GRAPHIC HEIGHT	
50.254		1000mm	120mm	x25 

CURVED HINGE STOPPER



STOPPER DETAILS





INFORMATION

This transparent Stopper with hinge features a straight shape and a 1000mm length. Also it is suitable for being used with 130mm graphic height labels and it allows to be fitted on most of the standard shelf profiles thanks to its hinged gripper at the top. Ideal for improvising the overall look of the shelf fronts and for highlighting the promotions of products for sale.

DIMENSIONS

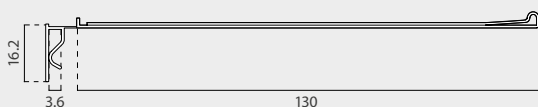
*mm



STRAIGHT H.	COLOR	LENGTH	GRAPHIC HEIGHT	
50.255		1000mm	130mm	x25 

STRAIGHT HINGE STOPPER



PROFILE DETAILS





INFORMATION

This shelf Extension Profile is suitable for being used with the most of the standard shelf fronts thanks to its adhesive strip at the front, also is suitable for being used with 26mm height price labels. This Extension Profile is ideal for improvising the overall look of the shelf fronts in the store and for highlighting the the products on sale.

DIMENSIONS

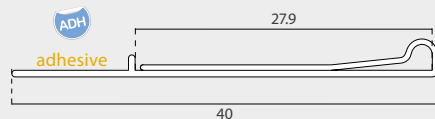
*mm



ADHESIVE EXT.	COLOR	LENGTH	GRAPHIC HEIGHT	
50.246		1320mm	26mm	x25 

ADHESIVE EXTENSION
FOR PROFILE



PROFILE DETAILS



INFORMATION

This profile features a front adhesive for attaching labels and it can be used on most of the standard shelf fronts thanks to its hinged clip at the back. There are 3 profile lengths available. Ideal for improvising the overall look of the shelf fronts and for highlighting the promotions of the products for sale.

DIMENSIONS

*mm

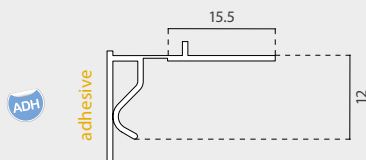

HINGE	COLOR	LENGTH	
50.105		120mm	x100 
50.106		150mm	x100 
50.250		2000mm	x25 

ADHESIVE HINGE PROFILE



RAIL DETAILS

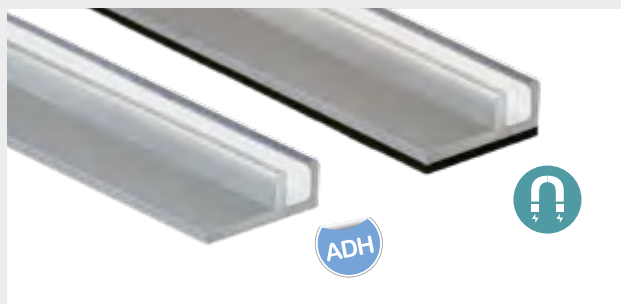







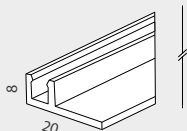





INFORMATION

*mm

These 8mm height rails are suitable for being used with all our dividers. There is magnetic and adhesive option available and also, 1000mm or 1320mm length for both options. They are ideal for creating an appropriate organization on the shelves management.



RAIL	LENGTH		
50.508	1320mm	x10 	 
50.514	1000mm	x10 	 
50.510	1320mm	x10 	 
50.516	1000mm	x10 	 

RAIL FOR DIVIDER



RAIL DETAILS

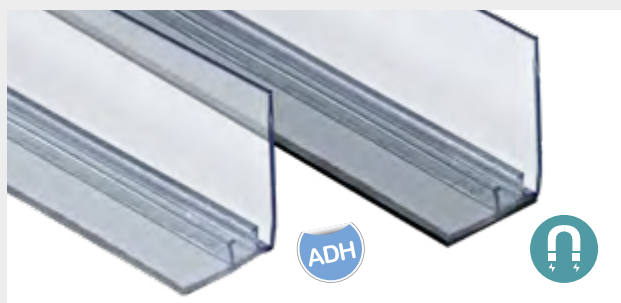

INFORMATION

*mm

These 30mm height rails are suitable for being used with all our dividers. There is magnetic and adhesive option available and also, 1000mm or 1320mm length for both options. They are ideal for creating an appropriate organization on the shelves management.

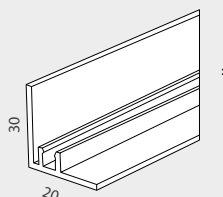

FRONT HEAD	LENGTH		
50.507	1320mm	x10 	 
50.517	1000mm	x10 	 
50.509	1320mm	x10 	 
50.515	1000mm	x10 	 

RAIL FOR DIVIDER WITH FRONT HEAD

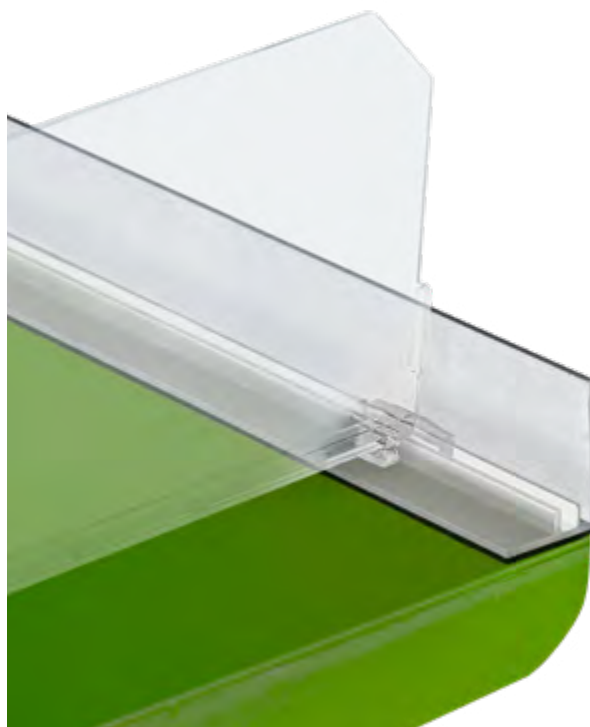

DIVIDER DETAILS



INFORMATION



*mm

These 60mm height dividers are suitable for being used with with all our rails. They are ideal for creating an appropriate organization on the shelves management. There are 280mm, 380mm and 480mm length available. They are usually used to separate medium-sized products like boxes cans or other goods.



DIVIDER 60

SIZE

50.504	60x280mm	x25 	
50.505	60x380mm	x25 	
50.506	60x480mm	x25 	

SHELF DIVIDER 60 HIGH



DIVIDER DETAILS



INFORMATION

*mm

These 120mm height dividers are suitable for being used with with all our rails. They are ideal for creating an appropriate organization on the shelves management. There are 280mm, 380mm and 480mm length available. They are usually used to separate medium-sized products like boxes cans or other goods.

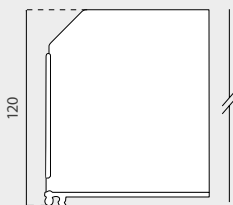

DIVIDER 120

SIZE

50.501	120x280mm	x25 	
50.502	120x380mm	x25 	
50.503	120x480mm	x25 	

SHELF DIVIDER 120 HIGH



DIVIDER DETAILS



INFORMATION

*mm

These 180mm height dividers can be easily separated by hand, so this way, they are 3 different lengths available (280, 380 and 480mm). They are ideal for creating an appropriate management on the shelves. They are often used to separate all types of products, like boxes, bottles, food, cans or other goods and also, the products can be easily removed thanks to the lack of a front stop.

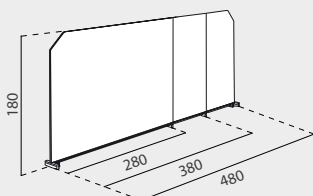

NO FRONT SIZE

50.560 280/380/480x180mm

x20 

SECTIONABLE SHELF DIVIDER



DIVIDER DETAILS



INFORMATION

*mm

These 180mm height dividers can be easily separated by hand, so this way, they are 3 different lengths available (280, 380 and 480mm). They are ideal for creating an appropriate management on the shelves. They are often used to separate all types of products, like boxes, bottles, food, cans or other goods and also, thanks to its front stop, the products are perfectly arranged on both sides of the shelf.

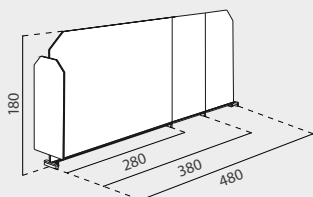

T FRONT SIZE

50.561 280/380/480x180mm

x20 

SECTIONABLE SHELF DIVIDER WITH "T" FRONT



DIVIDER DETAILS



INFORMATION

*mm

These transparent 180mm height dividers can be easily separated by hand, so this way, they are 3 different lengths available (280, 380 and 480mm). They are ideal for creating an appropriate management on the shelves. They are often used to separate all types of products, like boxes, bottles, food, cans or other goods and also, thanks to its front stop in the form of "L", the products are perfectly ordered to the right side of the shelf while the left side allows an easy removal of the product.

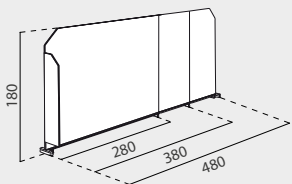

RIGHT FRONT SIZE

50.562	280/380/480x180mm	x20 
--------	-------------------	--

SECTIONABLE SHELF DIVIDER WITH RIGHT FRONT



DIVIDER DETAILS



INFORMATION

*mm

These transparent 180mm height dividers can be easily separated by hand, so this way, they are 3 different lengths available (280, 380 and 480mm). They are ideal for creating an appropriate management on the shelves. They are often used to separate all types of products, like boxes, bottles, food, cans or other goods and also, thanks to its front stop in the form of "L", the products are perfectly ordered to the left side of the shelf while the right side allows an easy removal of the product.

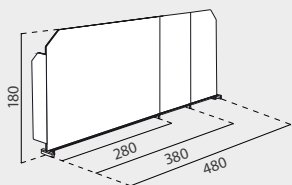

LEFT FRONT SIZE

50.563	280/380/480x180mm	x20 
--------	-------------------	---

SECTIONABLE SHELF DIVIDER WITH LEFT FRONT



PUSHER DETAILS





INFORMATION

*mm

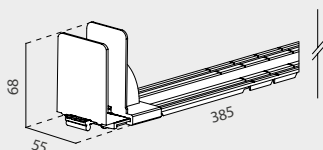
This transparent Divisible Pushing Lane is 385mm length and features 2 retainers. With a pusher-on-track design for use on any flat surface and display having an existing front fence. Variable steel spring force keeps a large variety of products faced. They are ideal for creating an appropriate organization on the shelves management.



PUSHING LANE	COLOR	SIZE	
50.851		55x385x68mm	x25 

DIVISIBLE PUSHING LANE



PUSHER DETAILS





INFORMATION

*mm

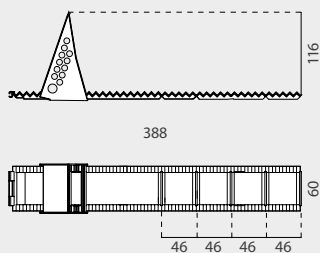
This Manual Shelf Pusher is composed by plastic parts made of transparent injected polycarbonate. With a pusher-on-track design for use on any flat surface and display having an existing front fence. Variable steel spring force keeps a large variety of products faced. They are ideal for creating an appropriate organization on the shelving management.



BREAKABLE	COLOR	SIZE	
50.500		60x388x115mm	x25 

DIVISIBLE MANUAL PUSHER



PUSHER DETAILS



INFORMATION

*mm

This white Shelf Pusher is 20mm width and features a blue transparent acrylic 390mm length lane. With a pusher-on-track design for use on any flat surface and display having an existing front fence. It features 2 pushing force (normal and double). They are ideal for creating an appropriate organization on the shelves management.

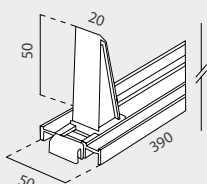

PUSHER 20

SIZE

50.520	50x390mm	Normal push force	x25 
50.522	50x390mm	Double push force	x25 

SHELF PUSHER 20



PUSHER DETAILS



INFORMATION

*mm

This white Shelf Pusher is 50mm width and features a blue transparent acrylic 390mm length lane. With a pusher-on-track design for use on any flat surface and display having an existing front fence. It features 2 pushing force (normal and double). They are ideal for creating an appropriate organization on the shelves management.

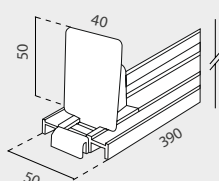

PUSHER 40

SIZE

50.521	50x390mm	Normal push force	x25 
50.523	50x390mm	Double push force	x25 

SHELF PUSHER 40



RETAINER DETAIL





INFORMATION

DIMENSIONS

*mm

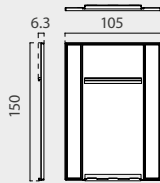
Plus Retainer is a shelving management accessory made of injected polycarbonate. It is suitable to combine with Manual Shelf Pusher (ref. 50.500) for increase support surfaces. With a push-on-track design for use on any flat surface and display having an existing front fence. They are ideal for creating an appropriate organization on the shelves management



RETAINER	COLOR	SIZE	
50.857		105x6.3x150mm	x25 

PLUS RETAINER



SUPPORT DETAILS





INFORMATION

DIMENSIONS

*mm

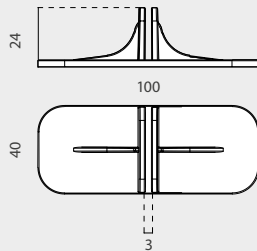
This 25mm height Support for dividers is made of transparent injected polycarbonate. It is suitable for being used with acrylics up to 3mm thickness. With a wide 100mm base design for using on any flat surface, they are ideal for creating an appropriate organization on the shelving management at POS.



SUPPORT	COLOR	SIZE	MAX. THICK
50.524		40x100x25mm	3mm

DIVIDER SUPPORT



GATE DETAILS









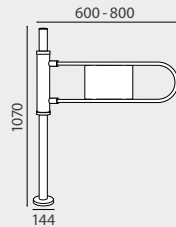

INFORMATION

DIMENSIONS *mm

These access gates are designed to be used in areas to positively indicate the entrance/exit flow and is particularly suited to where maximum security is not required. This checkout closer is simply installed onto the floor of the checkout line. The checkout channel can be open or closed through simple operation. Left or right Handed operation and 2 widths available. Double sided sign and mounting screws are included. Chromed finish.



	COLOR	HAND	WIDTH	
50.170		Right	600mm	x1 
50.171		Left	600mm	x1 
50.172		Right	800mm	x1 
50.173		Left	800mm	x1 

STANDING ACCESS GATE



GATE DETAILS

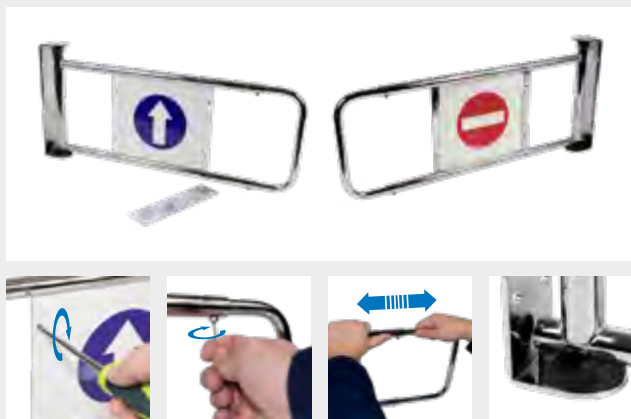



INFORMATION

DIMENSIONS *mm

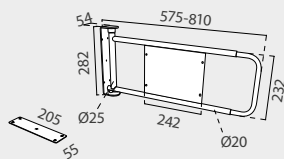
Adjustable Access Gate is easy installed onto the side of the checkout unit. It is designed to be opened through 90° in either direction to suit any requirement. With a 575 to 810mm width adjustable design. Double sided sign and mounting screws are included. With chromed finish.



GATE	COLOR	LENGTH	
50.175		575-810mm	x1 

ADJUSTABLE ACCESS GATE

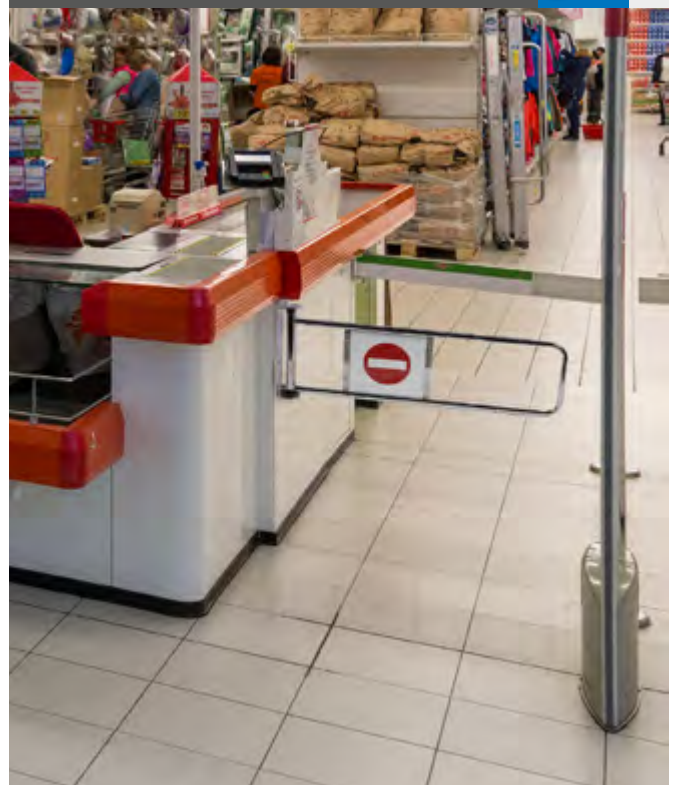

NEW



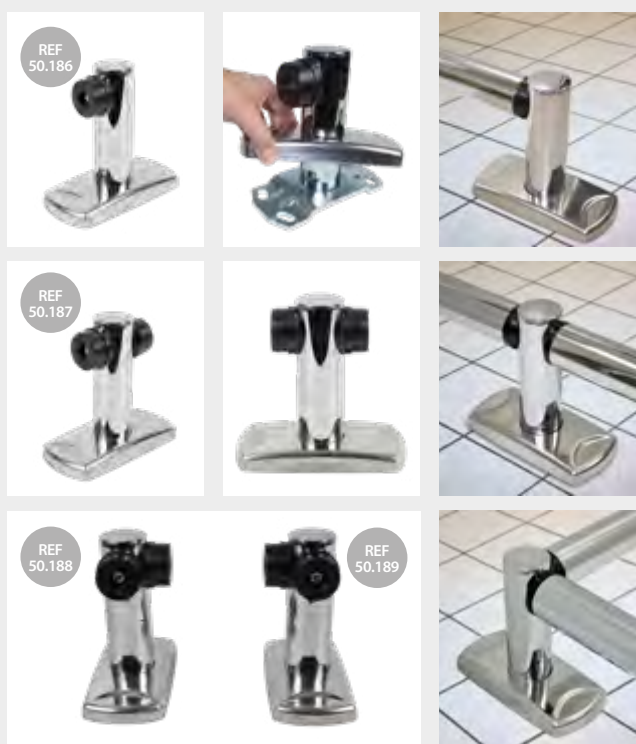



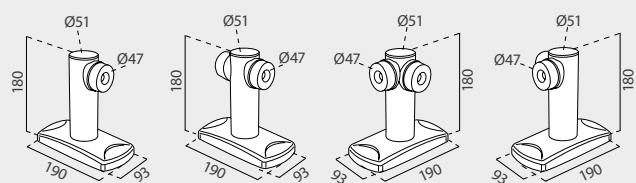

CARTSTOP DETAILS



DIMENSIONS

*mm



	COLOR	CONNECTION	SIZE	
50.186		END	190x93x180mm	x1 
50.187		DOUBLE	190x93x180mm	x1 
50.188		CORNER RIGHT	190x93x180mm	x1 
50.189		CORNER LEFT	190x93x180mm	x1 

TUBE DETAILS



DIMENSIONS

*mm



	COLOR	CONNECTION	LENGTH	
50.190		TUBE	1000mm	x1 
50.191		TUBE	1500mm	x1 
50.192		TUBE	2000mm	x1 

CARTSTOP PROTECTOR



STORE ACCESSORIES Plastic Shopping Baskets

BASKET DETAILS



INFORMATION

This Basket is made of break-resistant plastic with durable folding black plastic handles, also it is stackable to save valuable floor space. It features a front space for personalising with graphic. There are 5 colors available.

DIMENSIONS

*mm

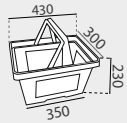

BASKET	COLOR	SIZE
50.150		430x230x300mm x5

BASKET WITH TWO HANDLES



BASKET DETAILS



INFORMATION

This Basket is made of break-resistant plastic and features 4 wheels with 2 durable folding black plastic handles, one of the handles allows a comfortable movement of the basket. also it is stackable to save valuable floor space. 3 colors available.

DIMENSIONS

*mm

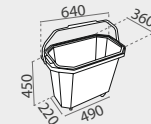

TROLLEY	COLOR	SIZE
50.152		640x450x360mm x5

TROLLEY BASKET WITH FOUR WHEELS



BASKET DETAILS



INFORMATION

This Basket is made of break-resistant plastic and features 2 wheels with 2 durable folding black plastic handles, one of the handles allows a comfortable movement of the basket. also it is stackable to save valuable floor space. 3 colors available.

DIMENSIONS

*mm

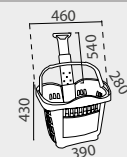

EXTENDABLE	COLOR	SIZE
50.151		460x280x430mm x5

BASKET WITH EXTENDABLE HANDLE



STORE ACCESSORIES Turnomatic

QUEUING SYSTEM DETAILS

INFORMATION



This turn-o-matic system for queue management contains: screen + ticket dispenser + remote control + ticket roll + anchoring system + signage vinyl.



COMPLETE

SCREEN TYPE

50.833

2 Digits

x1

COMPLETE QUEUING SYSTEM KIT



QUEUING SYSTEM DETAILS

INFORMATION



This Queuing System Kit contains: screen + remote control + anchoring system.



QUEUING

SCREEN TYPE

50.832

2 Digits

x1

QUEUING SYSTEM



DISPENSER DETAILS

INFORMATION



Once your customer has taken a ticket, they are free to continue shopping. This makes their waiting time more productive for them and you and they will often buy more high margin last minute items.

DISPENSER

SIZE

50.834



350x250x300mm

x1

50.834BK



350x250x300mm

x1

TICKET DISPENSER



ROLL DETAILS

INFORMATION



It features 2000 tickets per roll and 3 digits per ticket. There are 5 colors available and they are ideal for the queuing management or for raffles.

TICKET ROLL

COLOR

TICKETS/ROLL

50.835



2000

x1

TURN TICKET ROLL



GUN DETAILS



INFORMATION

These Label Guns features 1 or 2 dialing lines and 3 combinations of available digits.

LABEL GUN	TYPE		
50.843	1 line / 6 digits	x1	
50.844	2 lines / 8+6 digits	x1	
50.845	2 lines / 8+8 digits	x1	

PRICE LABEL GUN



INK ROLLER DETAILS



INFORMATION

Ink roller replacement compatible with three price label gun models. Pack of 6 rollers.

DOUBLE LEG	SIZE		
50.852	190x93x180mm	x6	

INK ROLLER REPLACEMENT



NEEDLE DETAILS

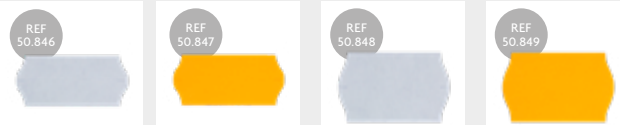

INFORMATION

Label rolls for price label guns. Available in 2 sizes and two colors, white and orange.

TUBE	COLOR	SIZE	LABELS/ROLL	
50.846		26x12mm	1500	x5
50.847		26x12mm	1500	x5
50.848		26x16mm	1000	x5
50.849		26x16mm	1000	x5

PRICE LABEL ROLL

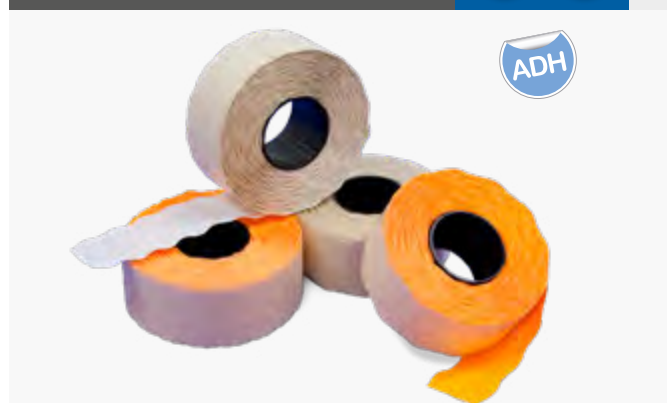

TAGGING GUN DETAILS



INFORMATION

Great for attaching tags and labels to clothes, toys, household items. All tagging guns come with wrist strap and protective needle cover.

TAGGING GUN	MODEL		
50.836	Standard	x1	
50.837	Fine	x1	

TAGGING GUNS

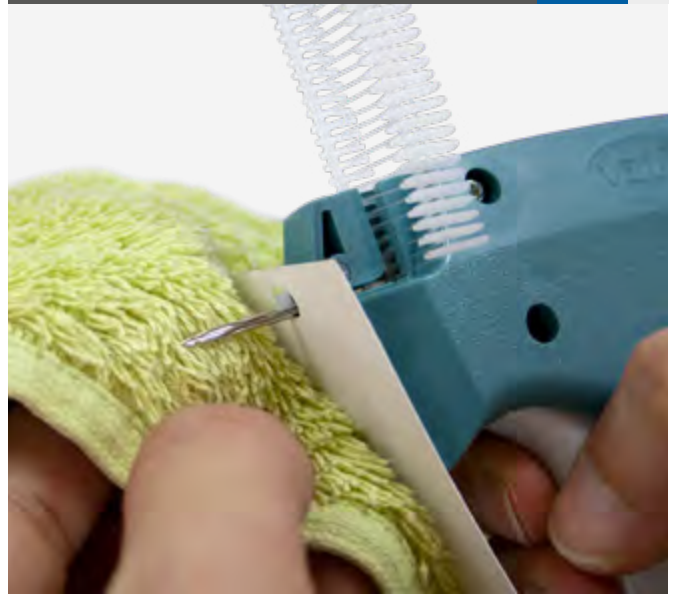

NEEDLE DETAILS

*mm

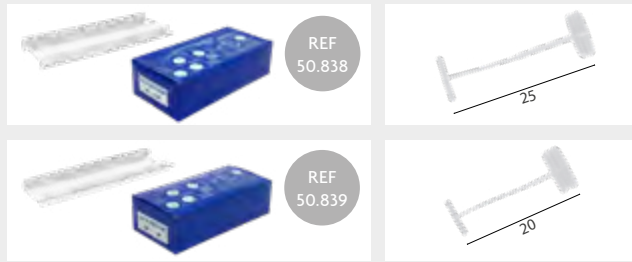

INFORMATION

Plastic barbs for Standard and Fine tagging guns. Sold in pack of 5000 pieces.

BARBS	MODEL	LENGTH	
50.838	Standard	25mm	x5000
50.839	Fine	20mm	x5000

TAGGING GUN BARBS



NEEDLE DETAILS

INFORMATION *mm

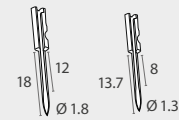

REF 50.841 REF 50.842

Needle replacements for Standard and Fine tagging guns. Sold in pack of 5 needles.

NEEDLES	MODEL	SIZE	
50.841	Standard	Ø1.8x18mm	x5
50.842	Fine	Ø1.3x13.7mm	x5

NEEDLES FOR TAGGING GUN



LOOP PIN DETAILS

INFORMATION

*mm



LENGTH



This flexible and easily adjustable plastic loop pin is beaded for an easy adjustment. It is ideal for attaching the price labels directly to the products.

PLASTIC STRAP

LENGTH

12.497	3" (76.20mm)	x1000	
12.498	4" (101.60mm)	x1000	
12.499	5" (127.00mm)	x1000	
12.500	6" (152.40mm)	x1000	
12.501	7" (177.80mm)	x1000	

PLASTIC BEADED LOOP PIN



LOOP PIN DETAILS

INFORMATION

*mm



LENGTH



This flexible and easily adjustable plastic loop pin is one of the most used attaching systems at retail stores. It is ideal for attaching the price labels directly to the products.

BEADED STRAP

SIZE

12.492	3" (76.20mm)	x1000	
12.493	4" (101.60mm)	x1000	
12.494	5" (127.00mm)	x1000	
12.495	6" (152.40mm)	x1000	
12.496	7" (177.80mm)	x1000	

PLASTIC LOOP PIN



PULL BOX DETAILS



INFORMATION

This pull box features a retractable metallic cable and an adhesive plate with a retractable cable from 0 to 1000mm of length. Ideal as an anti thieves resource in supermarkets or retail stores.

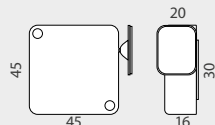

CABLE LENGTH

50.571	1000mm	x25	
--------	--------	-----	--

RETRACTABLE PULL BOX



DIVIDER DETAILS



DIMENSIONS

*mm

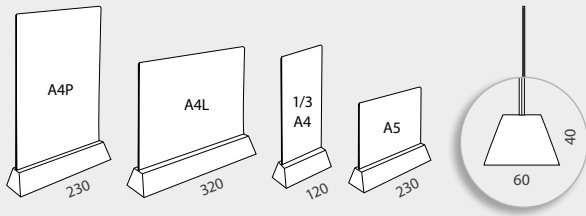

INFORMATION

This Card Holder features a colored plastic base (3 colors available) with a transparent document holder available in 4 sizes. Ideal as marketing tool for a whole range of businesses such as restaurants, hotels, receptions, waiting rooms or supermarket as checkout divider. Graphic sheet not included.

A5 HOLDER	COLOR	SIZE	E
50.134		A5 210x148mm	x10
1/3 A4 HOLDER	COLOR	SIZE	E
50.437		1/3 A4 100x210mm	x10
A4 HOLDER	COLOR	SIZE	E
50.439		A4 landscape 297x210mm	x10
50.435		A4 portrait 210x297mm	x10

BASE DIVIDER

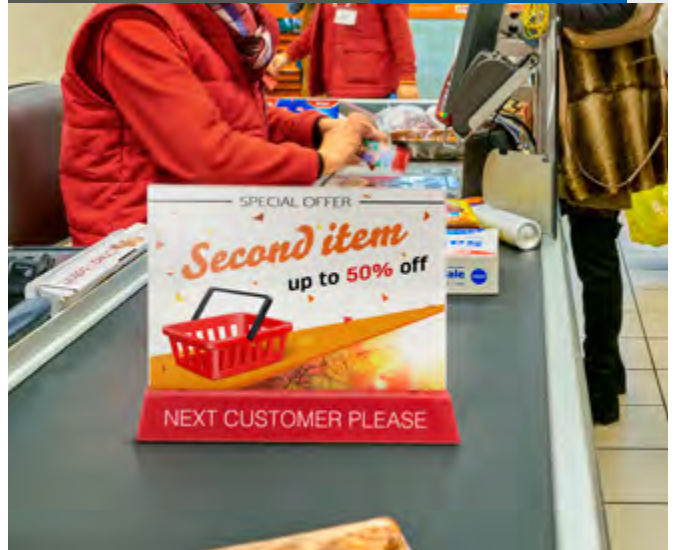

DIVIDER DETAILS

*mm



INFORMATION

This 350mm length Checkout Divider is made of anodised aluminium profile and finished with grey plastic endcaps. Ideal for being used with checkout counters.

DIVIDER	LENGTH	E
50.804	350mm	x1

CHECKOUT DIVIDER



* the graphic customization at this page are available but not included

ID ADHESIVE SAFETY PIN CARD HOLDER

HOLDER DETAILS



INFORMATION

ID Holders with adhesive front and safety pin. On white or blue finish.

DIMENSIONS *mm

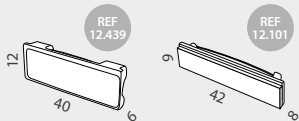

PIN HOLDER	COLOR	CARD INSERT SIZE		
12.439		40x12mm	x50	
12.101		42x9mm	x100	

ID ADHESIVE SAFETY CLIP CARD HOLDER

HOLDER DETAILS



INFORMATION

ID Holders with clip, adhesive front or safety pin. Available on transparent, white or grey finish.

DIMENSIONS *mm



ADHESIVE	COLOR	CARD INSERT SIZE		
12.100		12x29mm	x100	
12.443		12x25mm	x50	
12.102		19x19mm	x100	

ID INSERT SAFETY PIN CARD HOLDER

HOLDER DETAILS



INFORMATION

ID insert card holders with safety pin at back. Available on white or grey plastic finish.

DIMENSIONS *mm

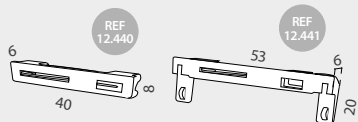

PIN HOLDER	COLOR	CARD INSERT SIZE		
12.440		40x7mm	x50	
12.441		52x20mm	x50	

CLAMP CARD HOLDER

HOLDER DETAILS



INFORMATION

ID Card with transparent plastic holder and metallic or plastic clamp which prevents damage clothing.

DIMENSIONS *mm

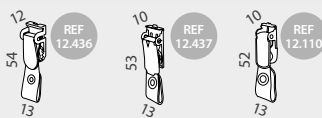

CLAMP	COLOR	SIZE		
12.436		14x53mm	x50	
12.437		15x52mm	x50	
12.110		13x51mm	x100	

* plastic pockets at this page are available but not included

CLIP CARD HOLDER

HOLDER DETAILS

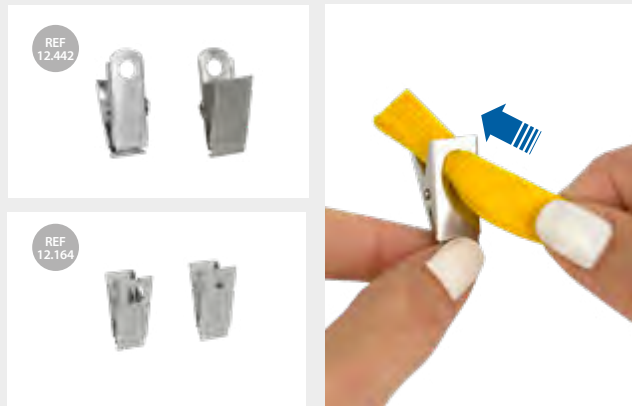

INFORMATION

DIMENSIONS

*mm





ID card holders with metallic clip. Ideal for being used with lanyards.



REF 12.442



REF 12.164

CLIP	COLOR	MATERIAL	SIZE	
12.442		Metal	12x30mm	x50 
12.164		Metal	10x27mm	x100 

CURVED ID BADGE

HOLDERS DETAILS







INFORMATION

DIMENSIONS

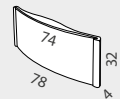
*mm

Curved plastic ID badge with safety pin at the back. Available in silver or black color.



CURVED	COLOR	GRAPHIC SIZE	
12.394		75x32mm	x10 
12.395		75x32mm	x10 

CLAMP CARD HOLDER

HOLDER DETAILS









INFORMATION

DIMENSIONS

*mm

These clamp card holders are suitable for lanyards, card pockets or magnetic ID badges. They feature a plastic finish.



CLAMP	COLOR	SIZE	
12.435		14x58x12mm	x50 
12.438		14x30x16mm	x50 
12.433		36x85x12mm	x50 

MAGNETIC CURVED ID BADGE

HOLDERS DETAILS







INFORMATION

DIMENSIONS

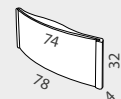
*mm

Curved plastic ID badge with magnetic attachment. It is available in 2 colors (silver and black).



MAGNETIC C.	COLOR	GRAPHIC SIZE	
12.392		75x32mm	x10 
12.393		75x32mm	x10 

* pockets, lanyards and badges at this page are available but not included

ACRYLIC ID BADGE

HOLDERS DETAILS







INFORMATION

Acrylic ID badge with safety pin and clip. There are 2 sizes available.

DIMENSIONS



ACRYLIC	COLOR	GRAPHIC SIZE	
12.390		50x40mm	x10 
12.391		60x25mm	x10 

SAFETY PIN CARD HOLDER

POCKET DETAILS

DIMENSIONS



INFORMATION

Transparent ID Card holder with safety pin and clip for quick and easy attachment.

SAFETY PIN	GRAPHIC SIZE	
12.105	90x55mm	x50 

PVC CARD POCKET 95x55

POCKET DETAILS

DIMENSIONS



INFORMATION

Landscape transparent PVC pocket with clamp which prevents damage clothing.

PVC 95x55	GRAPHIC SIZE	
12.107	95x55mm	x50 

PVC CARD POCKET

POCKET DETAILS

DIMENSIONS

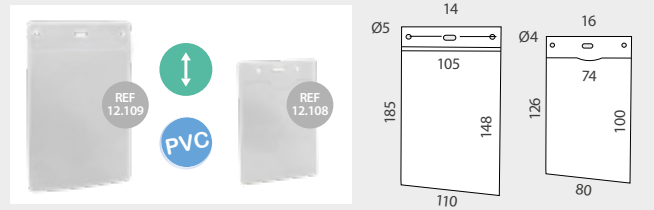

INFORMATION

Transparent PVC portrait ID pocket for cards on A6 or 74x100mm format.

POCKET 74x100	GRAPHIC SIZE	
12.108	74x100mm	x50 

POCKET A6	CARD SIZE	
12.109	A6- 105x148mm	x50 

FRAMED ID BADGE

HOLDERS DETAILS







INFORMATION

Black framed plastic ID badge with safety pin. Available in 2 sizes.

DIMENSIONS



FRAMED	COLOR	GRAPHIC SIZE	
12.398		75x25mm	x10 
12.399		75x35mm	x10 

MAGNETIC FRAMED ID BADGE

HOLDERS DETAILS







INFORMATION

Black framed plastic ID badge with magnetic attachment. 2 sizes available.

DIMENSIONS



MAGNETIC	COLOR	GRAPHIC SIZE	
12.396		75x25mm	x10 
12.397		75x35mm	x10 

HOLDERS DETAILS



INFORMATION

DIMENSIONS

*mm

Insert pocket for holding landscape or portrait ID Cards. Ideal for being used with the lanyards.

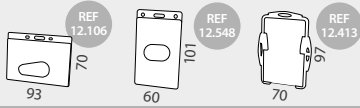

RIGID POCKET	CARD SIZE		
12.106	86x54mm	x10	
12.548	55x85mm	x10	
12.413	54x86mm	x10	

CARD RIGID POCKET



HOLDERS DETAILS



INFORMATION

DIMENSIONS

*mm

Insert black pocket for holding landscape or portrait ID Cards. Ideal for being used with the lanyards.

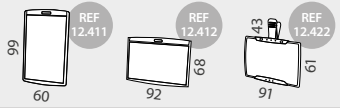

BLACK POCKET	CARD SIZE		
12.411	54x86mm	x10	
12.412	86x54mm	x10	
12.422	89x49mm	x10	

CARD BLACK POCKET





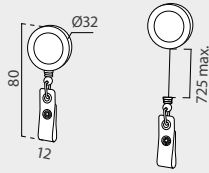
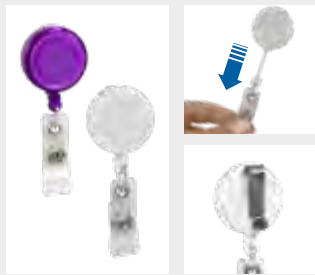

DIMENSIONS *mm



INFORMATION

Retractable reel for holding ID Cards. It is ideal as a card holder keychain

RETRACTABLE	COLOR	MAXIMUM LENGTH	
12.103		725mm	x50 
12.104		725mm	x50 

RETRACTABLE CARD HOLDER



DIMENSIONS *mm

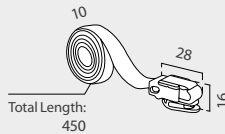

INFORMATION

This 450mm length Lanyard has a plastic clip for holding ID Cards or visitor passes.

PLASTIC	SIZE	
12.432	450x11mm	x50 

PLASTIC CLIP ID LANYARD



DIMENSIONS *mm

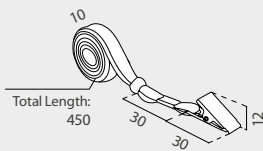
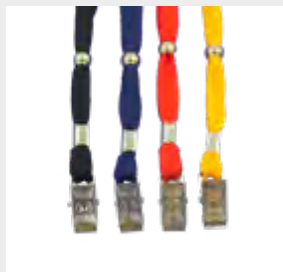

INFORMATION

This 450mm length Lanyard has a metallic clip and a metallic attachment.

METALLIC	SIZE	
12.429	450x11mm	x50 

METALLIC CLAMP ID LANYARD

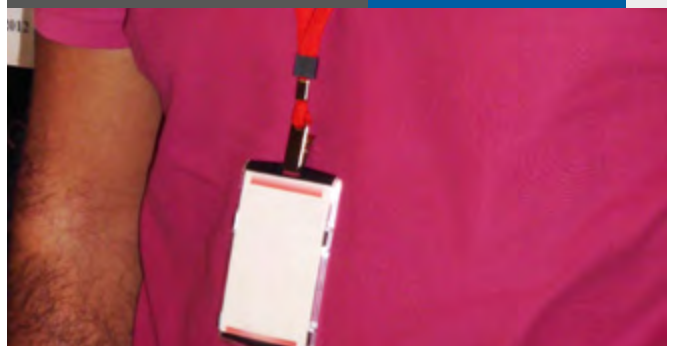

DIMENSIONS *mm

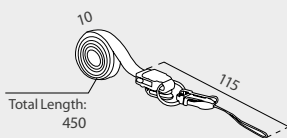
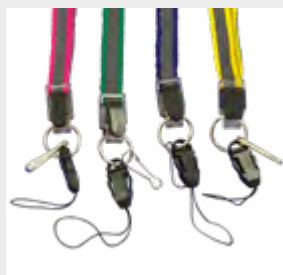

INFORMATION

450mm length Lanyard with plastic clip, phone cord and metallic tension clip.

MULTI	SIZE	
12.431	450x11mm	x50 

MULTIFUNCTION ID LANYARD



* lanyards at this page are available but not included

DISPENSER DETAILS

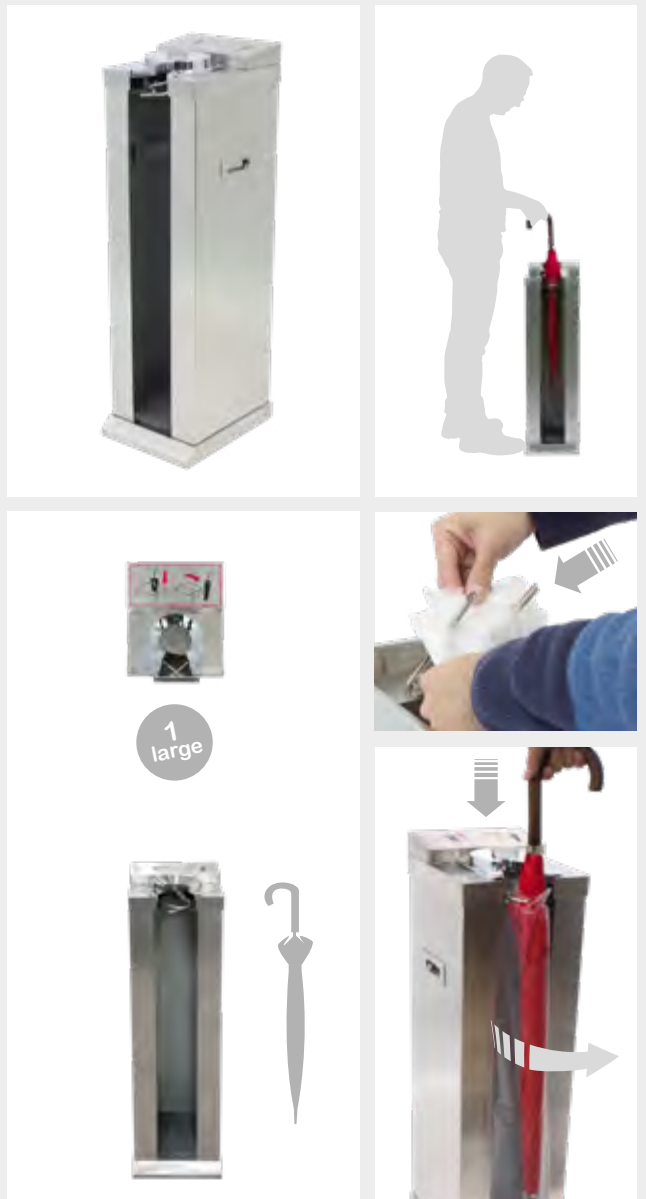

UMBRELLA BAG
SINGLE DISPENSER



INFORMATION

DIMENSIONS

*mm

Keep your facilities clean and safe avoiding accidents with this dispenser. Save on service and cleaning material. Protect easily your products and facilities from the water. Offering a space more comfortable for your employees and customers. Insert the umbrella through the upper hole and pull it horizontally outwards. Now you will have your umbrella on and you will be able to drive safely and comfortably by the establishment. It is ideal for being used at malls, supermarkets or at retail stores.

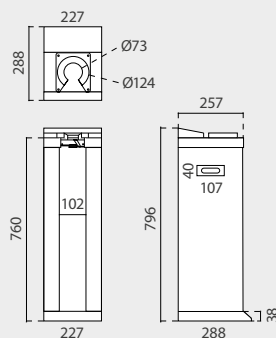

SINGLE	QTY	N.W	G.W	C.B.M	SIZE
Packing	1	5.85kg	7.40	0.053	280x345x854mm
81.500		227x288x796mm			

STORE ACCESSORIES Umbrella Bag Double Dispenser

DISPENSER DETAILS



INFORMATION

Keep your facilities clean and safe avoiding accidents with this dispenser. Save on service and cleaning material. Protect easily your products and facilities from the water. Offering a space more comfortable for your employees and customers. Insert the umbrella through the upper hole and pull it horizontally outwards. Now you will have your umbrella on and you will be able to drive safely and comfortably by the establishment. It is ideal for being used at malls, supermarkets or at retail stores.

DIMENSIONS

*mm

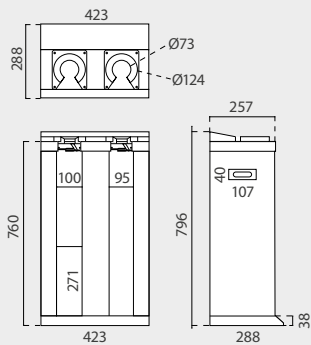

DOUBLE	QTY	N.W	G.W	C.B.M	SIZE
Packing	1	11.30kg	12.60kg	0.0793	340x470x845mm
81.501		423x288x796mm			

UMBRELLA BAG DOUBLE DISPENSER





BAGS DETAILS

DIMENSIONS

*mm



SMALL BAGS	QTY	N.W	G.W	C.B.M	SIZE
Packing	1	0.15kg	0.16kg	0.0005	170x140x20mm
81.502		x100 			
LARGE BAGS	QTY	N.W	G.W	C.B.M	SIZE
Packing	1	0.26kg	0.27kg	0.0007	240x140x20mm
81.503		x100 			

ASHTRAY DETAILS



INFORMATION

DIMENSIONS *mm

The Beresford outdoor ashtray pole is rust-resistant to keep the sleek, silver color throughout almost any weather conditions. Also, is lightweight enough to be transported to any location, but with the cast iron base and stainless steel frame it will remain sturdy. Its design makes it ideal for shopping centers, airports and office buildings looking to keep their grounds free from unsightly butts.

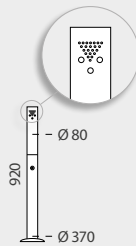

BERESFORD	QTY	N.W	G.W	C.B.M	SIZE
Packing	1	5.95kg	6.35kg	0.15	400x400x950mm
13.288		Ø370(base)xØ80x920mm			

BERESFORD

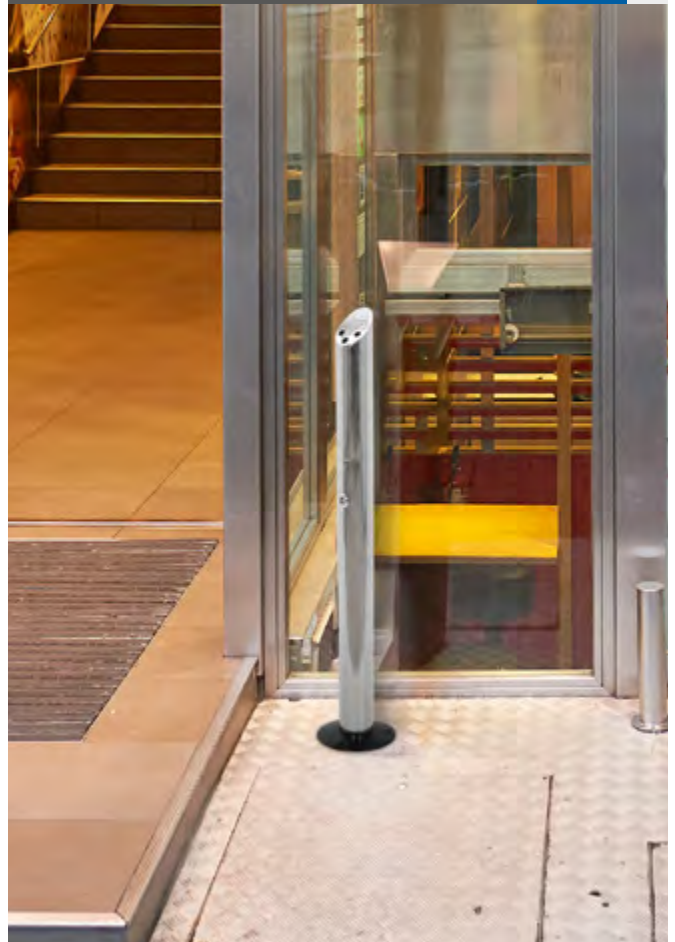

ASHTRAY DETAILS

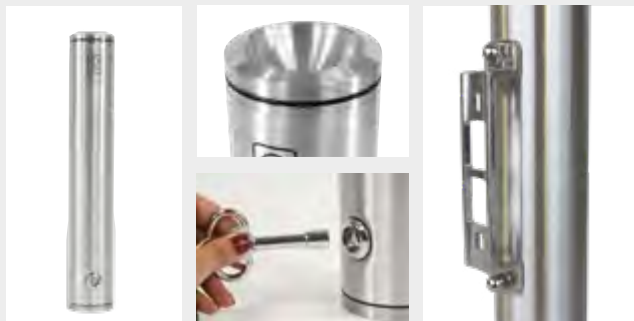

INFORMATION

DIMENSIONS *mm

Sunbury ashtray is made of stainless steel and aluminium. With closing key system and accessories included. Its design makes it ideal for shopping centers, airports looking to keep their grounds free from unsightly butts.

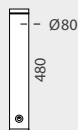

SUNBURY	QTY	N.W	G.W	C.B.M	SIZE
Packing	1	1.2kg	1.5kg	0.01	110x110x510mm
13.286		Ø80x480mm			

SUNBURY



ASHTRAY DETAILS



INFORMATION

The Popkum ashtray is made of stainless steel and aluminium. With closing key system and accessories included. It is ideal for mall centers, airports or offices.

*mm



POPKUM	QTY	N.W	G.W	C.B.M	SIZE
Packing	1	1.1kg	1.4kg	0.01	110x110x510mm
13.284			Ø80x480mm		

POPKUM



ASHTRAY DETAILS



INFORMATION

Ashtray made of stainless steel and aluminium. With closing key system and accessories included. Ideal for being used at shopping centers, airports or at offices.

*mm



PAULSON	QTY	N.W	G.W	C.B.M	SIZE
Packing	1	1.4kg	1.7kg	0.01	110x110x510mm
13.285			80x80x480mm		

PAULSON

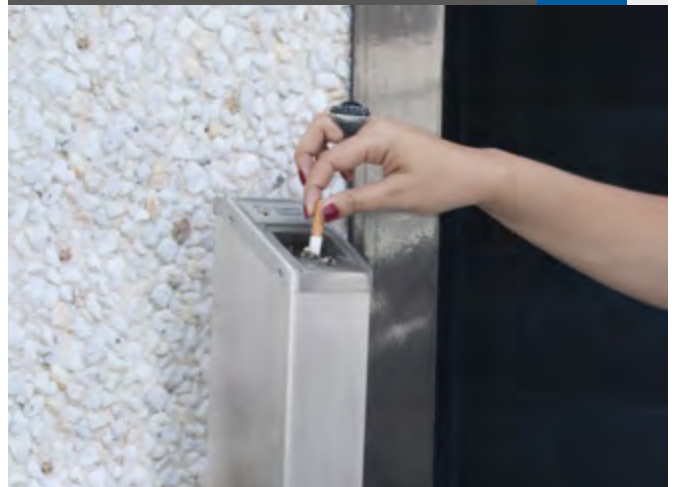

ASHTRAY DETAILS



INFORMATION

The Femdale ashtray is made of stainless steel and aluminium. With closing key system and accessories included. It is ideal for mall centers, airports or offices.

*mm



FEMDALE	QTY	N.W	G.W	C.B.M	SIZE
Packing	1	1.45kg	1.75kg	0.01	110x110x510mm
13.287			80x80x480mm		

FEMDALE



POSTS DETAILS

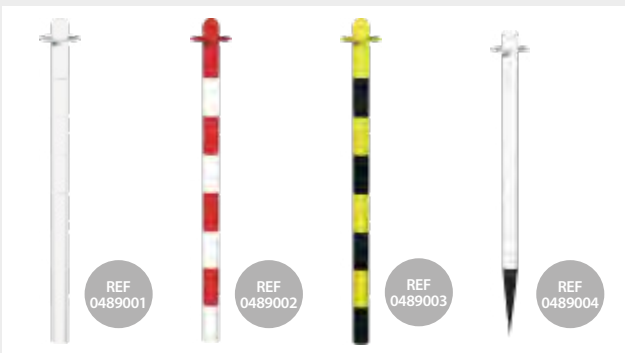





INFORMATION

DIMENSIONS

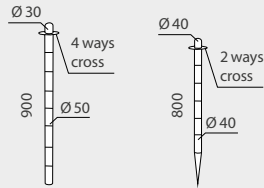
* mm

These lightweight design poles come with 4-way and 2-way connecting ring. Various colors and finishes available. Ideal for areas like work lines and anywhere it is necessary to protect areas or to mark zones of prohibited or renewed access.



LIGHTWEIGHT	COLOR	POLE	TOP	HEIGHT
0489001		Ø 50mm	Ø 30mm	900mm
0489002		Ø 50mm	Ø 30mm	900mm
0489003		Ø 50mm	Ø 30mm	900mm
0489004		Ø 40mm	Ø 40mm	800mm

LIGHTWEIGHT BARRIER POST

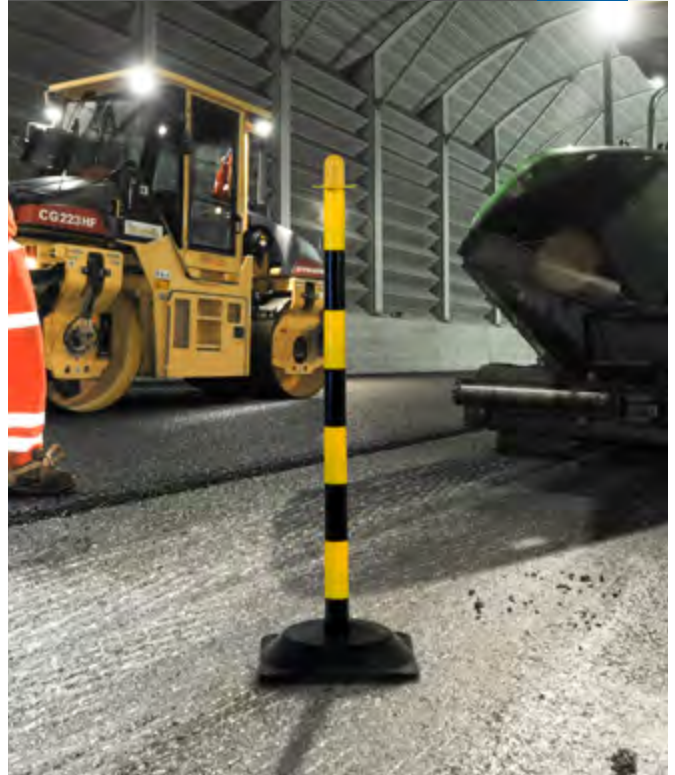

* Base is available but not included.

BASES DETAILS

made of rubber



REF 0489005

made of plastic



4 L

REF 0489006

DIMENSIONS

* mm

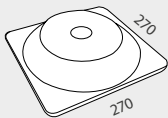

REF 0489005

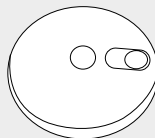

REF 0489006

INFORMATION

These bases are the best complement for light barrier posts, there are two different models, one made of plastic and refillable with 4l of water. The other one is manufactured in rubber and with dimensions of 270x270mm.

LIGHTWEIGHT	MATERIAL	SIZE
0489005	Rubber	Square - 270x270mm
0489006	Plastic	Round - Ø300mm

BARRIER POLE BASES



* Post is available but not included.

POST DETAILS



FLEXIBLE BOLLARD



INFORMATION

DIMENSIONS

* mm

This flexible bollard is suitable for mounting on any surface. It is made of polyurethane and has a reflective band to improve its visibility. Thanks to its flexibility, this bollard always recovers its initial position once it has been hit.

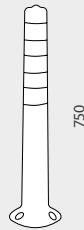

FLEXIBLE

HEIGHT

80.302

750mm

POST DETAILS



PORTABLE POST



INFORMATION

DIMENSIONS

* mm

These portable post features a 6kg rubber base. It has a highly visible reflective band and it is suitable for tape or chain. Ideal for work lines and anywhere it is necessary to protect areas or to mark zones of prohibited or renewed access.

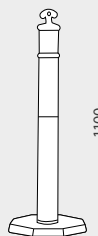

PORTABLE

HEIGHT

80.301

1100mm

INFORMATION

DIMENSIONS *mm

This 300 height cone is made of polyethylene and it has a squared 220x220mm base and it features a 110mm reflective central band.

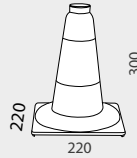

REFLECTIVE	COLOR	HEIGHT	BASE	WEIGHT	
4761002		300mm	220x220mm	0.25kg	x10

REFLECTIVE CONE



reflective

DIMENSIONS *mm

REF 80.513

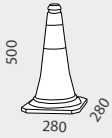

REF 80.512

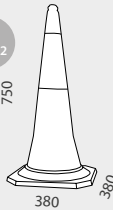

REF 80.511

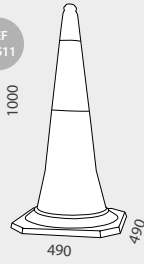

INFORMATION

These cones are made of polyethylene and they feature an horizontal band made with highly visible reflective. There are 3 sizes available.

RUBBER BASE	COLOR	HEIGHT	BASE	BASE WEIGHT	
80.513		500mm	280x280mm	1.5kg	
80.512		750mm	380x380mm	2.5kg	
80.511		1000mm	490x490mm	5.0kg	

REFLECTIVE CONES WITH RUBBER BASE



reflective

DIMENSIONS *mm

REF 80.501

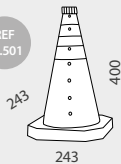

REF 80.502



REF 80.503

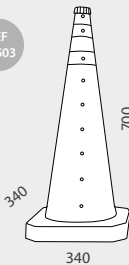

INFORMATION

These Collapsible cones are made of nylon and feature a base of ABS. 2 reflective bands are included. There are 3 sizes available.

COLLAPSIBLE	COLOR	HEIGHT	BASE	BASE WEIGHT	
80.501		400mm	243x243mm	0.55kg	
80.502		500mm	243x243mm	0.55kg	
80.503		700mm	340x340mm	0.95kg	

COLLAPSIBLE CONES WITH REFLECTIVE COLLARS



collapsible

reflective

CONE DETAILS



INFORMATION

DIMENSIONS

*mm

These Caution Cones are made of sturdy polypropylene with yellow finish. There are 2 models available, with slippery floor prevention signage or without it.

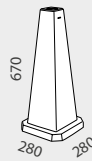

CONE	BASE	HEIGHT	WEIGHT		
80.603	280x280mm	670mm	1.1kg	x1	
80.604	280x280mm	670mm	1.1kg	x1	

CAUTION CONE



"A" BOARD DETAILS



INFORMATION

DIMENSIONS

*mm

The Caution "A" Board is made of sturdy polypropylene with yellow finish. There are 2 models available, with slippery floor prevention signage or without it.

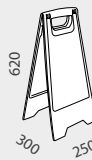

"A" BOARD	SIZE	WEIGHT		
80.601	250x300x620mm	0.6kg	x1	
80.602	250x300x620mm	0.6kg	x1	

CAUTION SIDEWALK



CHAINS DETAILS

DIMENSIONS *mm

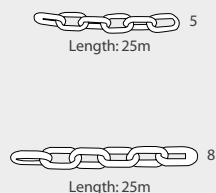
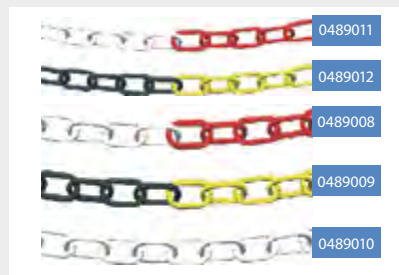

INFORMATION

These 25m chains are made of polyethylene. 2 widths and 3 colors available.

PLASTIC CHAIN	COLOR	WIDTH	LENGTH
0489011		5mm	25m
0489012		5mm	25m
0489008		8mm	25m
0489009		8mm	25m
0489010		8mm	25m

PLASTIC CHAIN

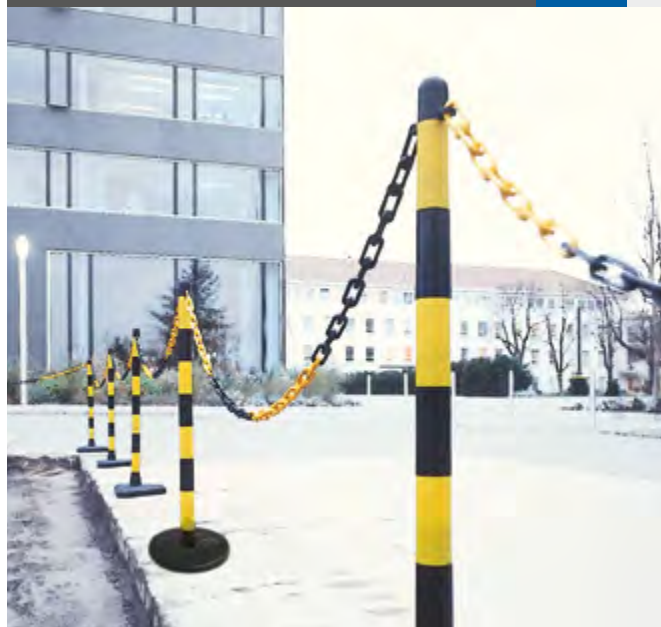

TAPES DETAILS

DIMENSIONS *mm

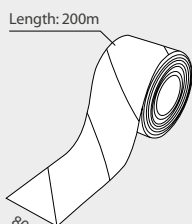

INFORMATION

These 200m length tapes are 80mm width. 2 colors available (black/yellow striped or red/white striped). Ideal to mark zones of prohibited or renewed access.

TAPES	COLOR	WIDTH	LENGTH
0479001		80mm	200m
0479004		80mm	200m

TAPE SIGNALLING



CONNECTORS DETAIL

INFORMATION

*mm

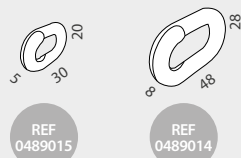

These chain connectors are made of white plastic and there are 2 sizes available. They are ideal for being used with chains and cones or with poles.



CONNECTORS	WIDTH
0489015	5mm
0489014	8mm

CHAIN CONNECTORS

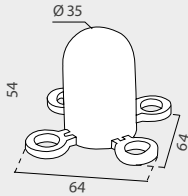

TOPPER DETAIL		DIMENSIONS	*mm
			
INFORMATION			
<p>These Tops are suitable for being used with chains and posts or cones. 2 colors.</p>			
POST-CONE TOP	COLORS		
0489024		x10	



TOPPER DETAILS		DIMENSIONS	*mm
			
INFORMATION			
<p>This cone topper is suitable for cones above 3kg weight. It features a 3m length and retractable red/white striped belt. Ideal to mark zones of prohibited access.</p>			
TOPPER WITH BELT	BELT LENGTH		
80.516	3m		



TOPPER DETAILS		DIMENSIONS	*mm
			
INFORMATION			
<p>This cone topper is ideal to improve the visibility of cones. It has a diameter of Ø20mm. Ideal for signalling areas delimited by cones in low light conditions.</p>			
FLASHLIGHT	DIAMETER		
80.504	8mm		



* Batteries are not included.

SIGN DETAILS

DIMENSIONS *mm

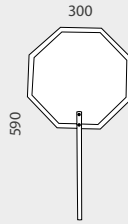
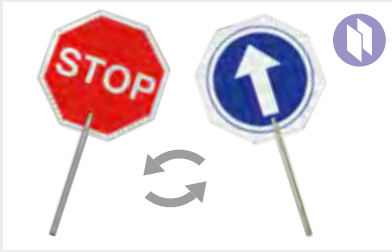

INFORMATION

One side has the "Stop" sign and the other one has the "one-way traffic" sign.

STOP/GO	SIZE	
0080011	590x300mm	x3 

STOP/GO SIGN PADDLE



BATON DETAIL

DIMENSIONS *mm

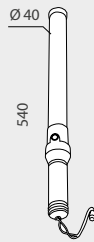
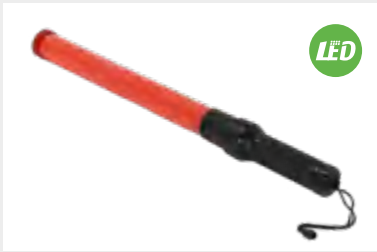

INFORMATION

This Red Traffic Baton features a LED illumination system and offers 3 operation modes: flashing light, steady light and off. It is ideal for traffic signaging.

RED BATON	LENGTH	DIAMETER
80.704	540mm	Ø40mm

RED TRAFFIC BATON



LAMPS DETAILS

DIMENSIONS *mm

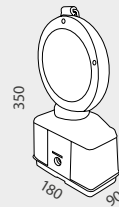

INFORMATION

LED flashing lamps are ideal to mark zones of prohibited access. 2 colors available.

FLASHING	COLOR	LED QUANTITY	
80.709		2 LEDs	x12 
80.710		2 LEDs	x12 

FLASHING LAMPS

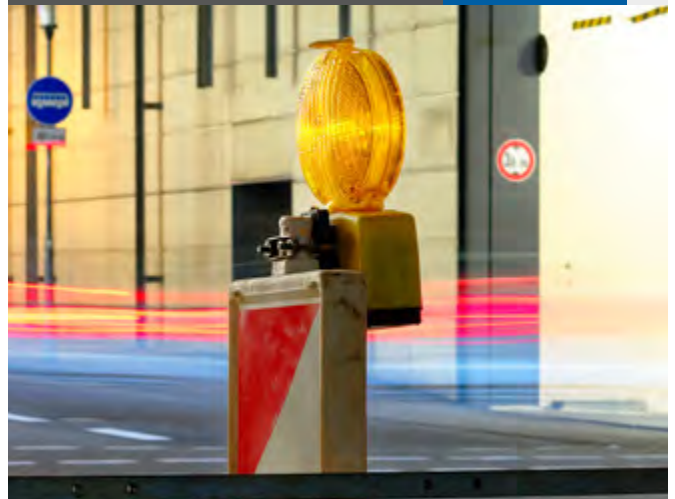

INFORMATION **DIMENSIONS** *mm

This sign is made of yellow plastic and it features a Ø60mm red reflective circle and a hook for poles. it is ideal to mark zones and for traffic signing.

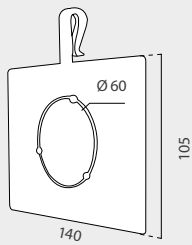

REFLECTIVE	SIZE
0489016	140x105mm

REFLECTIVE SIGN WITH HOOK



SIGN DETAIL **DIMENSIONS** *mm

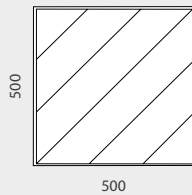

INFORMATION

This rear and reflective 500x500mm squared panel is ideal for protruding loads.

PROTRUDING	SIZE
00530001	500x500mm

REAR REFLECTIVE PANEL FOR PROTRUDING LOADS



SUPPORTS DETAILS **DIMENSIONS** *mm

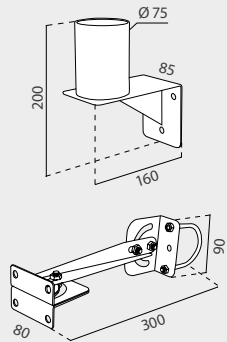

INFORMATION *mm

One model is suitable for wall mounting, and other one for wall or pole mounting.

SUPPORTS	MIRROR SIZE
80.104	for Ø800mm to Wall
80.124	for Ø450mm and Ø600mm to Wall or Pole

MIRROR SUPPORTS



* Mirror not included.

MIRROR DETAILS

DIMENSIONS *mm

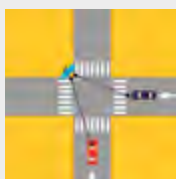
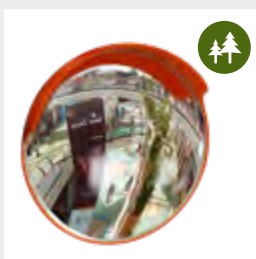

2 DIRECTIONS CONTROL

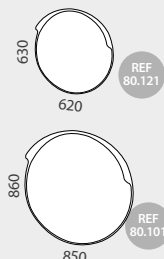

INFORMATION

Outdoor mirror with top cover and an adjustable viewing angle of 130°. For tubes with a min. diameter of Ø50mm or Ø70mm. Hardware and anchorage are included.

OUTDOOR	Ø MIRROR	Ø TUBE	SIZE
80.101	Ø800mm	Ø70mm	850x860x140mm
80.121	Ø600mm	Ø50mm	620x630x110mm

OUTDOOR MIRROR



MIRROR DETAILS

DIMENSIONS *mm

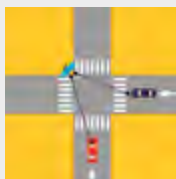
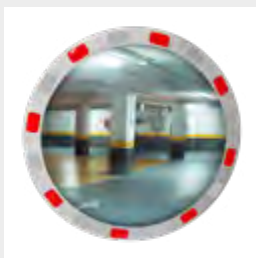

2 DIRECTIONS CONTROL

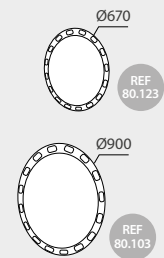

INFORMATION

Round mirror with polycarbonate lens and adjustable bending angle of 130°, featuring red and white strips reflective bands. Hardware and anchorage is included.

REFLECTIVE	MIRROR DIAMETER	SIZE
80.103	Ø800mm	900x900x120mm
80.123	Ø600mm	670x670x120mm

REFLECTIVE MIRROR



MIRROR DETAILS

DIMENSIONS *mm

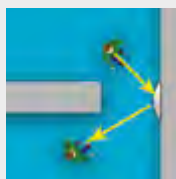
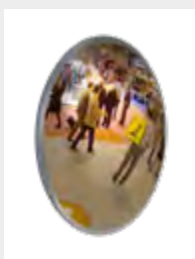

2 DIRECTIONS CONTROL

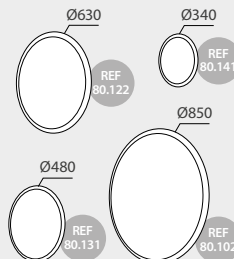

INFORMATION

Round Indoor mirror with polycarbonate lens and adjustable bending angle of 130°, featuring red and white reflective bands. Hardware and anchorage included.

INDOOR	MIRROR DIAMETER	SIZE
80.102	Ø800mm	850x850x130mm
80.122	Ø600mm	630x630x90mm
80.131	Ø450mm	480x480x80mm
80.141	Ø300mm	340x340x60mm

INDOOR MIRROR



MIRROR DETAILS

DIMENSIONS *mm

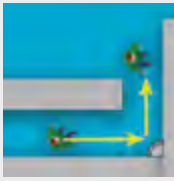
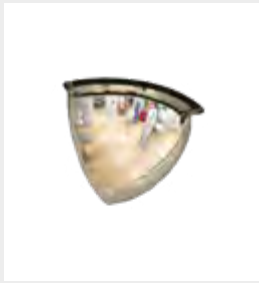

90° VIEW CONTROL CEILING

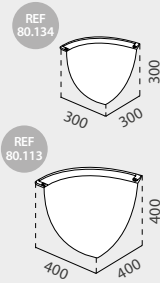

INFORMATION

Mirror with polycarbonate lens, 2 directions control and an adjustable bending angle of 90°. With a high impact resistance. Fixing screws included.

90°	MIRROR DIAMETER	SIZE
80.113	Ø650mm	400x400x400mm
80.134	Ø450mm	300x300x320mm

90° MIRROR



MIRROR DETAILS

DIMENSIONS *mm

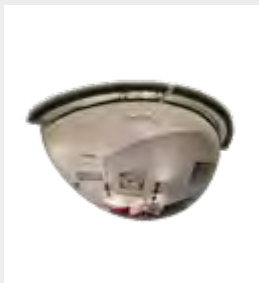

180° VIEW CONTROL CEILING

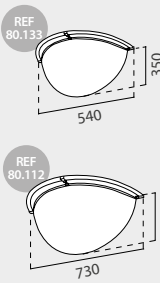

INFORMATION

This mirror with polycarbonate lens has an adjustable bending angle of 180°. Also, it features a high impact resistance. The fixing screws are included.

180°	MIRROR DIAMETER	SIZE
80.112	Ø650mm	730x420x380mm
80.133	Ø450mm	540x350x300mm

180° MIRROR

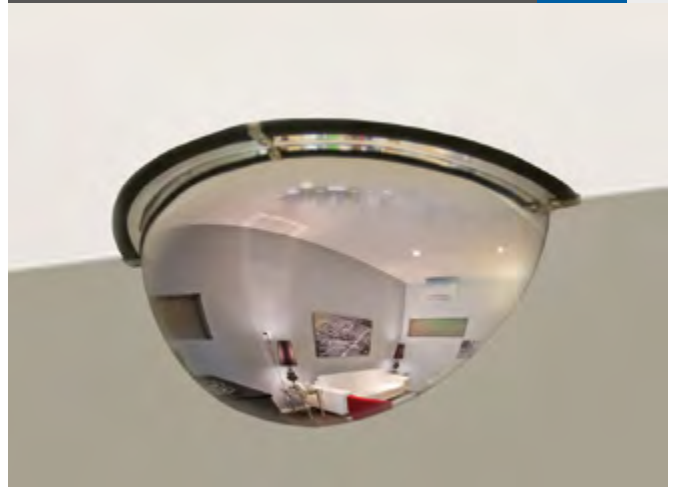

MIRROR DETAILS

DIMENSIONS *mm

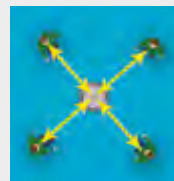

360° VIEW CONTROL CEILING

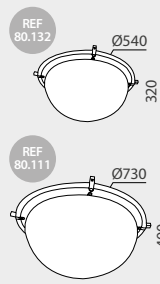

INFORMATION

This mirror has a lens made of polycarbonate with 4 direction control and 360° angle (adjustable). High impact resistance. Fixing screws included.

360°	MIRROR DIAMETER	SIZE
80.111	Ø650mm	730x730x400mm
80.132	Ø450mm	540x540x320mm

360° MIRROR



STOP DETAIL

DIMENSIONS *mm

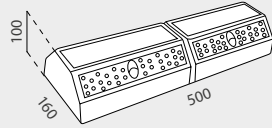

INFORMATION

This wheels rubber stopper allows the parking of the vehicle without exceeding the limit of the space. Easy assembly by fixing with screws (not included).

SMALL STOP SIZE

80.421 500x160x100mm

SMALL WHEEL STOP



STOP DETAIL



DIMENSIONS

*mm

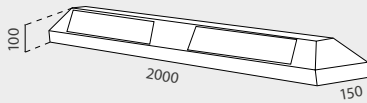

INFORMATION

This wheels rubber stopper allows the parking without exceeding the limit of the space. It can be used as a rail separator. Easy assembly by screws (not included).

LARGE STOP SIZE

80.427 2000x150x100mm

LARGE WHEEL STOP



GUARD DETAIL



DIMENSIONS

*mm

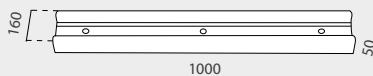

INFORMATION

This wall guard is designed to protect the vehicle and the wall. It is made of black rubber with yellow reflective central band. The guard protector is easy and quick to mount to wall by fixing with 3 screws.

WALL GUARD SIZE

80.426 1000x160x50mm

WALL GUARD

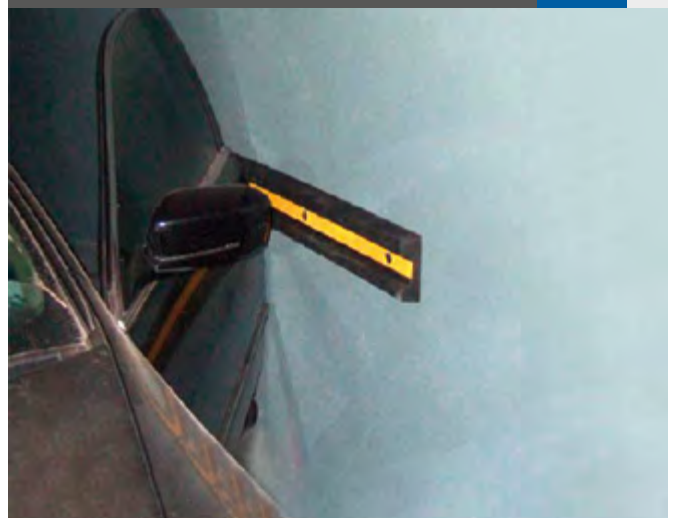

PROTECTORS DETAILS

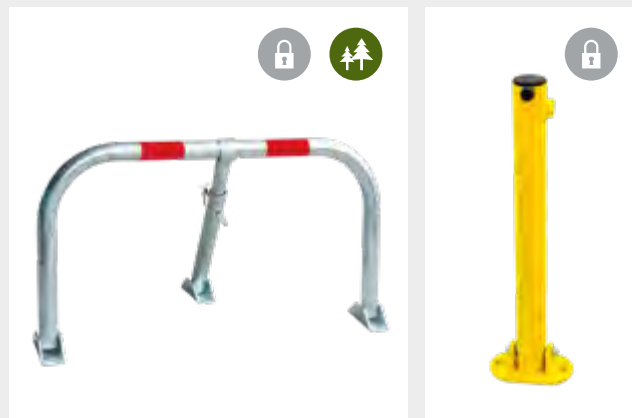

DIMENSIONS

*mm

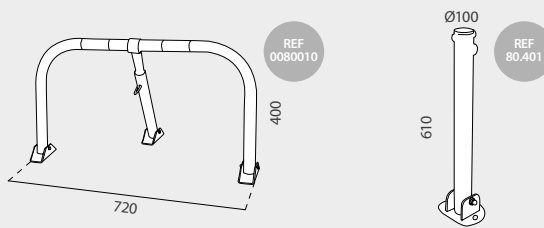

INFORMATION

These folding parking space protectors offer systems of great resistance. The first one (ref. 0080010) is a manual folding parking lock with padlock and features a robust system of great resistance thanks to its three points of anchorage. The second one (ref. 80.401) is a parking folding post made of steel, finish with yellow UV resistant paint for better visibility and durability. Easy to use and assembly. Also, they feature lock and keys (included). They are ideal for restricting access to the parking spaces.

RESTRICT	SIZE
0080010	720x400mm

PROTECTOR	SIZE	TUBE DIAMETER
80.401	175x610x100mm	Ø60mm

RAWLPLUG AND SCREW

RAWLPLUG DETAIL

INFORMATION



This screw is made of metal and designed with expansion fit is ideal for solid materials such as walls or for concrete floors. Perfect for fixing wheel stoppers or parking accessories.

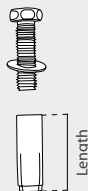

RAWLPLUG	LENGTH
80.611	50mm
80.613	70mm
80.614	90mm

PARKING SPACE PROTECTORS



*Screws are available but not included.

PROTECTORS DETAILS







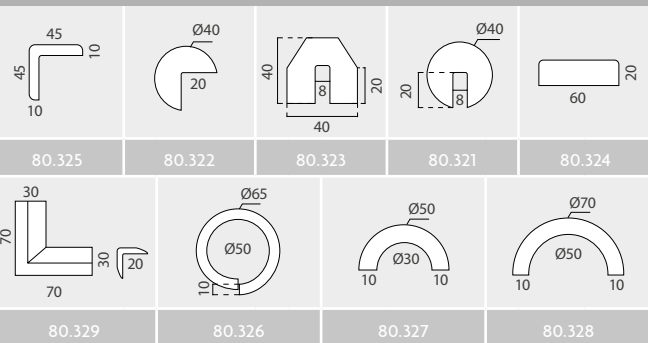





DIMENSIONS

*mm



INFORMATION

These protectors are made of polyurethane so they can be easily cut to the desired length. It is resistant to UV rays and includes a back adhesive for a correct fixation.

STRAIGHT	SIZE	WEIGHT	
80.324	60x20x1020mm	0.35kg	x1 
PU CORNER	SIZE	WEIGHT	
80.329	70x30x10mm	0.02kg	x1 
CORNER PR.	SIZE	WEIGHT	
80.325	45x45x1040mm	0.35kg	x1 
80.322	Ø40mm	0.35kg	x1 
CORNER PR.	SIZE	WEIGHT	
80.323	40x40x1010mm	0.4kg	x1 
80.321	Ø40x1030mm	0.35kg	x1 
CIRCULAR	SIZE	WEIGHT	
80.326	Ø65x1000x10mm	0.5kg	x1 
SEMICIRCULAR	SIZE	WEIGHT	
80.327-RD	Ø30x50x1000mm	0.25kg	x1 
80.327-YE	Ø30x50x1000mm	0.25kg	x1 
80.328-RD	Ø50x70x1000mm	0.3kg	x1 
80.328-YE	Ø50x70x1000mm	0.3kg	x1 

POLYURETHANE PROTECTORS



STRAIGHT CORNER GUARD



INFORMATION

This straight corner is 800mm high and it is ideal for the protection of right angle corners that are prone to receive blows. It has 3 perforated on each side. Made of high strength rubber and yellow reflective vinyl for an improved visibility.



STRAIGHT

SIZE

80.411

800x100x10mm

ROUNDED CORNER GUARD



INFORMATION

This straight corner is 800mm high and it is ideal for the protection of right angle corners. Featuring rounded angle. It has 3 perforated on each side. Made of high strength rubber and yellow reflective vinyl for an improved visibility.



ROUNDED

SIZE

80.412

800x120x20mm

RUBBER RAMP MODULAR

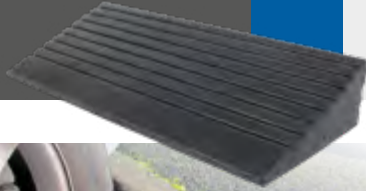

INFORMATION

This Modular Ramp is 600mm wide and it is ideal for saving curbs and small slopes at parking entrances, garages, etc. The Modular Ramp is made of high strength black rubber and it is designed to support up to 5 tons of weight.



MODULAR

SIZE

80.424

600x250x100mm

RUBBER RAMP ENDCAP



INFORMATION

This Endcap Ramp has a dimension of 250x250mm and it is ideal for being used with Modular Ramp. Endcap is made of high strength black rubber and it is designed to support up to 5 tons of weight.



ENDCAP

SIZE

80.425

250x250x100mm

RUBBER CABLE AND HOSE PROTECTOR

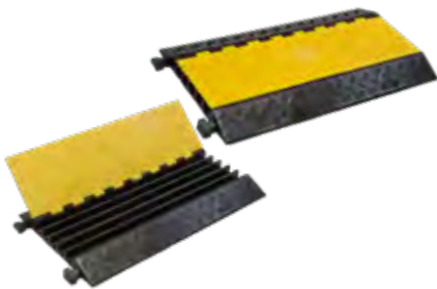

INFORMATION

Rubber protector with plastic cover, features 5 channels for cable up to 42mm. It supports up to 10 tons. Ideal for events, fairs, works, etc.

ST.RUBBER

SIZE

80.422

900x500x55mm



INFORMATION

Rubber 22.5° corner with plastic cover, features 5 channels for cable up to 42mm. It supports up to 10 tons. Ideal for events, fairs, works, etc.

CORNER

SIZE

80.423

310x500x55mm



INFORMATION

Rubber protector with plastic cover, features 2 channels for cable up to 90mm. It supports up to 40 tons. Ideal for events, fairs, works, etc.

HOSE

SIZE

80.428

900x615x105mm

CABLE PROTECTOR PLASTIC



40x13mm
channel

INFORMATION

Protector made of polyurethane with a cable channel of 40x13mm. Simple installation through "L" connections, without tools. Supports up to 1.5 tons. Ideal as an economic solution, ideal for shopping centers, construction areas, garages...

PROTECTOR	SIZE	CHANNEL SIZE
80.429	1000x140x20mm	40x13mm

PORTABLE SPEED BUMP



carrying bag
included



INFORMATION

Easy installation, can be folded in seconds to be able to transport it to another place. Made of polyurethane, supports up to 20 tons. Includes transport bag.

PORTABLE	SIZE
80.417	3000x250x25mm

durable rubber



SPEED BUMP 35mm HEIGHT

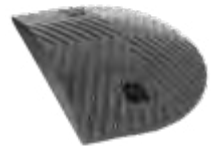

INFORMATION

Black rubber Reducer Stand-alone 500mm piece. Resistance to humidity and high temperatures.

35mm B	SIZE
80.413N	500x250x35mm

INFORMATION

Yellow rubber Reducer Stand-alone 500mm piece. Resistance to humidity and high temperatures.

35mm Y	SIZE
80.413A	500x250x35mm

INFORMATION

Black corner rubber Reducer Stand-alone piece. Resistance to humidity and high temperatures.

35 ENDCAP	SIZE
80.414	250x250x35mm

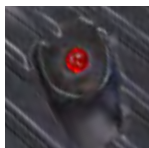

with cat's-eye
reflectors



SPEED BUMP 50mm HEIGHT

durable rubber



INFORMATION

This speed bump is made of rubber and includes 4 cat's eye reflectors for a better visibility. Great resistance to humidity and high temperatures.

50mm	SIZE
80.415	500x350x50mm

INFORMATION

Black corner rubber Reducer Stand-alone piece. Resistance to humidity and high temperatures. Ideal for being used with Speed Bump ref 80.415.

50 ENDCAP	SIZE
80.416	250x350x50mm

made of durable rubber

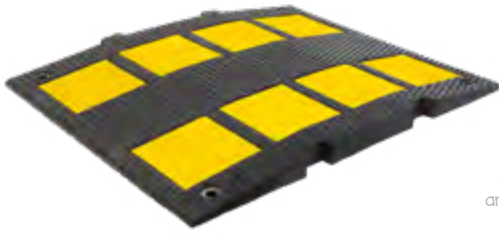

* Fixing screws are not included

SPEED HUMP

30mm HEIGHT



* Fixing screws are not included

INFORMATION

This 30mm high speed hump is made of durable rubber. Easy assembly by fixing with screws (not included). Great resistance to humidity and high temperatures.

30 HUMP	SIZE
80.418	500x600x30mm

INFORMATION

This 30mm high speed hump End is made of durable rubber. Easy assembly by fixing with screws (not included). Great resistance to humidity and high temperatures.

30 ENDCAP	SIZE
80.419	225x600x30mm

made of durable rubber

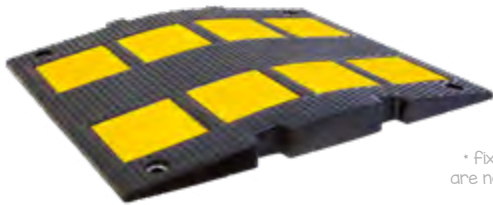

* Fixing screws are not included

SPEED HUMP

50mm HEIGHT



* Fixing screws are not included

INFORMATION

This 50mm high speed hump is made of durable rubber. Easy assembly by fixing with screws (not included). Great resistance to humidity and high temperatures.

50 HUMP	SIZE
80.431	500x600x50mm

INFORMATION

This 50mm high speed hump End is made of durable rubber. Easy assembly by fixing with screws (not included). Great resistance to humidity and high temperatures.

50 ENDCAP	SIZE
80.432	225x600x50mm



	EN	FR	PT	ES
	Carry bag included	Avec sac de transport	Inclui bolsa de transporte	Incluye bolsa de transporte
	One sided	Une face	Uma face	Una cara
	Double-Sided	Double face	Dupla face	Doble cara
	With motion	Avec mouvement	Com movimento	Con movimiento
	With light	Éclairé	Com luz	Con luz
	LED Technology	Technologie LED	Tecnologia LED	Tecnologia LED
	Telescopic	Télescopique	Telescópico	Telescópico
	Printed on textil	Impression sur toile	Impressão têxtil	Impresión sobre textil
	With lock	Avec serrure	Com fechadura	Con cerradura
	Rainproof	Imperméable	Impermeável	Impermeable
	Suitable for outdoor use	Pour l'extérieur	Para exterior	Para exterior
	With spotlights	Avec spot	Com focos	Focos incluidos
	With Adhesive	Avec adhésif	Com adesivo	Con adhesivo
	Cardboard	Carton	Cartão	Cartón
	With suction pad	Avec ventouse	Com ventosa	Con ventosa
	New Item	Nouvel article	Novidade	Producto nuevo
	Lightweight	Poids léger	Leve	Ligero
	Extraweight	Poids supplémentaire	Peso extra	Peso extra
	Flexible	Flexible	Flexível	Basculante
	Magnetic	Aimanté	Magnético	Magnético
	Plug-in	Électrique	Elétrico	A corriente
	Big Sizes	Grandes tailles	De grandes dimensões	Grandes dimensiones
	Portrait	Verticale	Vertical	Vertical
	Landscape	Horizontale	Horizontal	Horizontal
	Portrait / Landscape	Vertical ou horizontal	Vertical ou horizontal	Vertical u Horizontal
	"Click" System	Système "Click"	Sistema "Click"	Sistema "Click"
	With "genuine VELCRO® Brand system"	Avec "authentique système marque VELCRO®"	Com "genuíno sistema marca VELCRO®"	Con "genuíno sistema marca VELCRO®"
	Acrylic	Acrylique	Acrílico	Acrílico
	With antireflection protector	Avec protecteur antireflets	Com protetor anti-reflexo	Con protector antirreflejo
	Tools required	Outils nécessaires	Montagem com ferramentas	Requiere herramientas
	No tools required	Aucun outil requis	Montagem sem ferramentas	No requiere herramientas
	Capacity	Capacité	Capacidade	Capacidad
	Economic	Économique	Económico	Económico
QTY	Quantity	Quantité	Quantidade	Cantidad
NW	Net weight	Poids net	Peso líquido	Peso neto
GW	Gross weight	Poids brut	Peso bruto	Peso bruto
CBM	Cubic meter	Mètres cubes	Metro cúbico	Cubicaje
Size	Measures	Mesures	Medidas	Medidas